

Quick Start for tM-AD2

Dec 2015, Version 1.0.0

Congratulations!

Congratulations on purchasing the tM-AD2 the most popular automation solution for remote monitoring and control applications. This Quick Start Guide will provide information needed to get started with the tM-AD2. Please also consult the User Manual for detailed information on the setup and use of the tM-AD2.

What's in the shipping box?

In addition to this guide, the shipping box includes the following items:

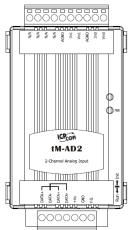

tM-AD2

Technical Support

- **ICP DAS Website**

<http://www.icpdas.com/>

Understanding the Hardware Specifications and Wiring Diagrams

Before installing the hardware, you should have a basic understanding of hardware specification and the wiring diagrams.

System Specifications :

System Specifications

Communication	
Interface	RS-485
Format	(N, 8, 1), (N, 8, 2), (O, 8, 1), (E, 8, 1)
Baud Rate	1200 ~ 115200 bps
Protocol	DCON, Modbus/RTU, Modbus/ASCII
Dual Watchdog	Yes, Module (2.3 seconds), Communication (Programmable)
LED Indicators	
Power	1 LED as Power Indicator
Isolation	
Intra-module Isolation, Field-to-Logic	3000 V _{dc}
EMS Protection	
ESD (IEC 61000-4-2)	±4 kV Contact for Each Terminal
	±8 kV Air for Random Point
EFT (IEC 61000-4-4)	±4 kV for Power
Surge (IEC 61000-4-5)	±3 kV for Power
Power Requirements	
Reverse Polarity Protection	Yes
Powered from Terminal Block	Yes, 10 ~ 30 V _{dc}
Consumption	0.8 W Max.
Mechanical	
Dimensions (W x L x H)	52 mm x 98 mm x 27 mm
Installation	DIN-Rail Mounting
Environment	
Operating Temperature	-25 ~ +75°C
Storage Temperature	-30 ~ +75°C
Humidity	10 ~ 95% RH, Non-condensing

I/O Specifications :

I/O Specifications

Analog Input		
Input Channels	2 Single-ended	
Type	0 ~ 500 mV, 0 ~ 1 V, 0 ~ 2.5 V, 0 ~ 5 V, 0 ~ 10 V, 0 ~ 20 mA, 4 ~ 20 mA	
Resolution	Normal Mode	14-bit
	Fast Mode	12-bit
Sampling Rate	Normal Mode	10 Hz total
	Fast Mode	200 Hz total
Accuracy	Normal Mode	+/-0.1%
	Fast Mode	+/-0.5%
Zero Drift	+/-20 μ V/ $^{\circ}$ C	
Span Drift	+/-25 ppm/ $^{\circ}$ C	
Input Impedance	Voltage	10 M Ω
	Current	125 Ω
Overvoltage Protection	120 V _{DC}	
Overcurrent Protection	Yes, 50 mA at 110 V _{DC}	
Open Wire Detection for 4 ~ 20 mA	Yes	

Wire Connection :

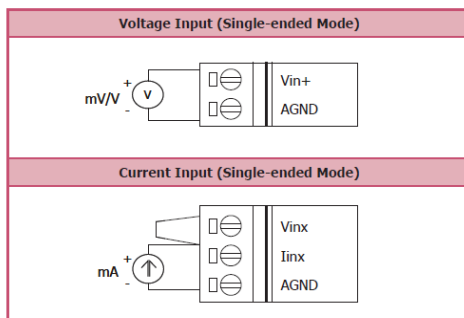

Pin Assignment :

Pin Assignments

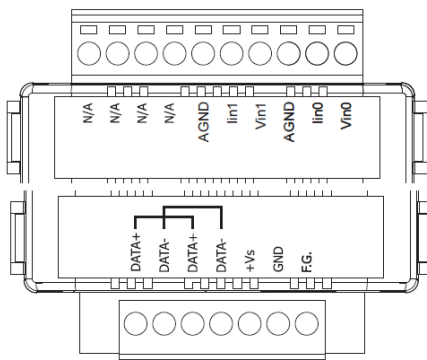



2 Booting the tM-Series in Init Mode

Make sure the switch placed in the "Init" position.

3 Connecting to the PC and the Power Supply

The tM-Series series is equipped with an RS-485 port for connection to a 232/USB converter to PC

Connect to the PC using an RS-485 Converter

Connect to PC using a USB Converter

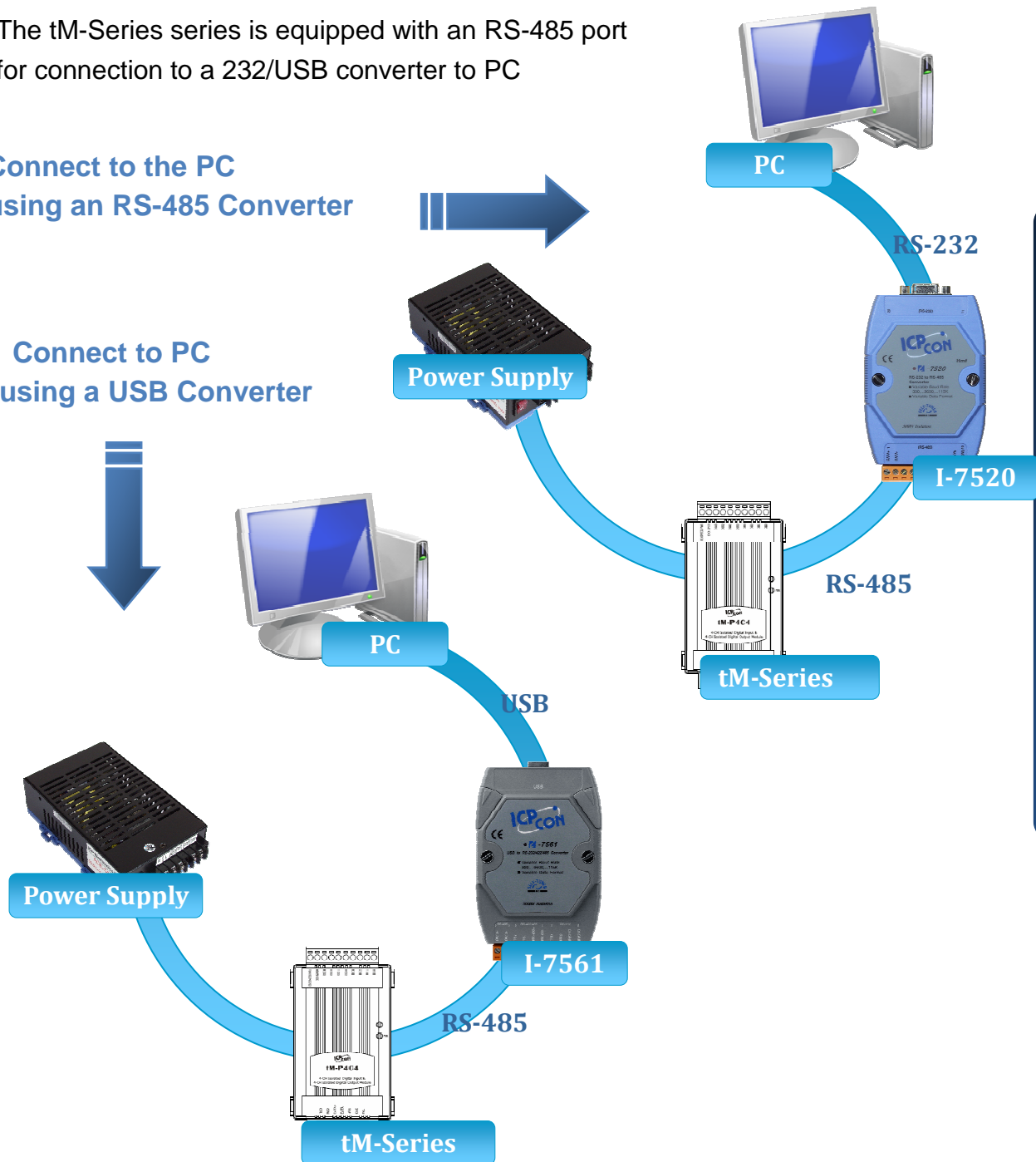

tM-AD2 Quick Start

4 Installing the DCON Utility

The DCON Utility is an easy-to-use tool designed to enable simple configuration of I/O modules that use the DCON protocol.

Step 1: Locate the DCON Utility



The DCON Utility can be obtained from the companion CD or from the ICPDAS FTP site:

ftp://ftp.icpdas.com/pub/cd/8000cd/napdos/driver/dcon_utility/

CD:\Napdos\Driver\DCON_Utility

5 Using the DCON Utility to Initialize the tM-Series Module

The tM-Series is an I/O module based on the DCON protocol, meaning that you can use the DCON Utility to easily initialize it.

Step 1: Run the DCON Utility_Pro



Double-click the DCON Utility Pro

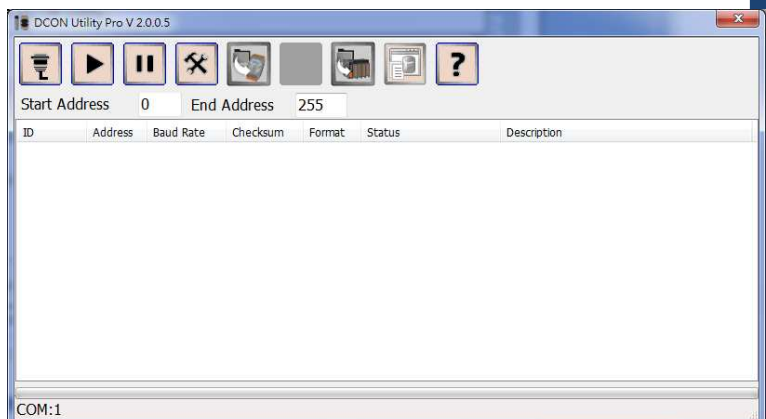

Step 2: Use the COM1 port to communicate with the tM-Series

Click the "COM Port" option from the menu and a dialog box will be displayed that will allow you to set the communication parameters as described in the table below.

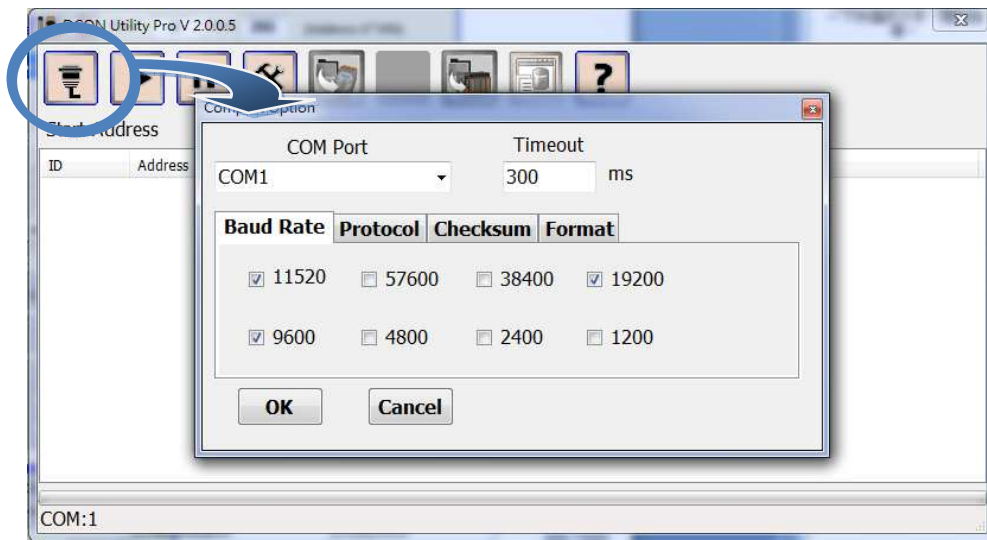

Communication parameter	Factory default Value
Address	00
Baud Rate	9600
Protocol	DCON
Checksum	Disabled
Parity	N,8,1

Step 3: Search for the tM-Series module

Click “Start Search” button from the toolbox to search for the tM-Series module. After the tM-Series module is displayed in the list, click “Stop Search” button.

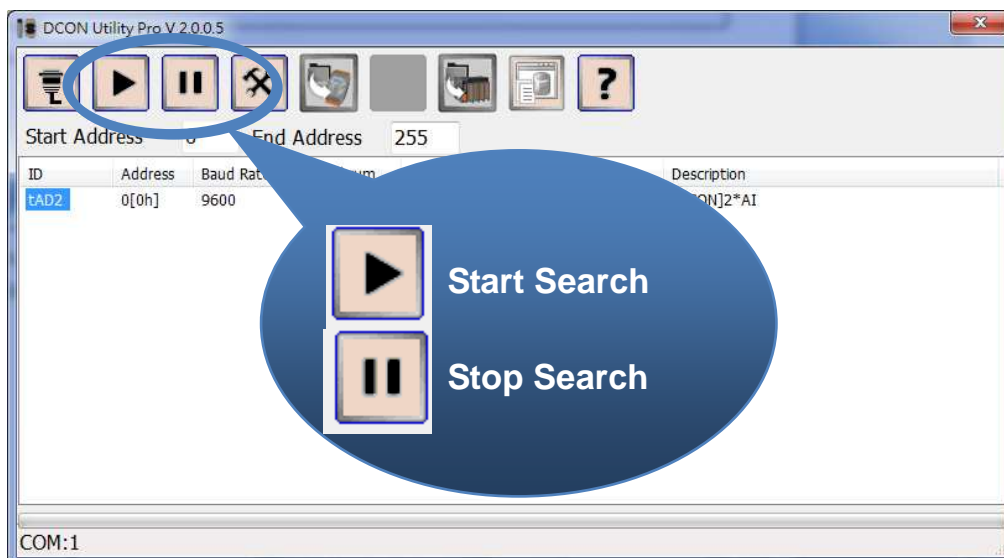

Step 4: Connect to the tM-Series

After clicking on the name of the module in the list, a dialog box will be displayed.

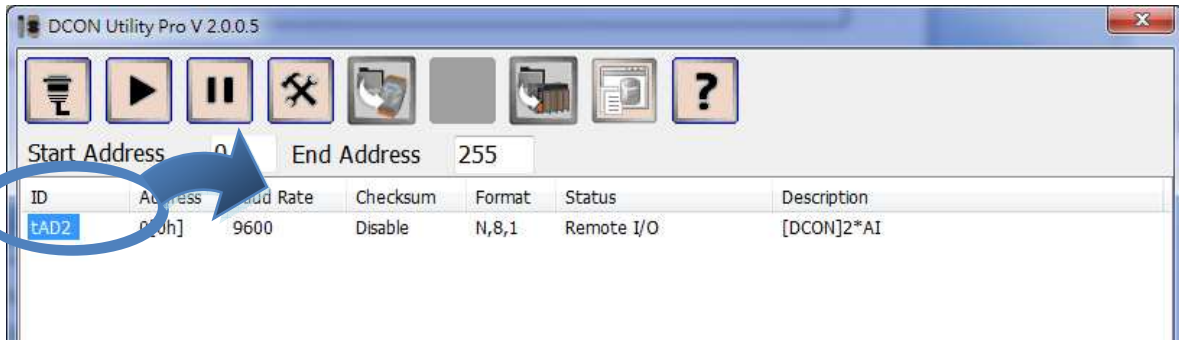

Step 5: Initialize the tM-Series module

Set the “Address” field in the dialog box to 1 and then click “Setting Module Configurations ” button to save the settings.

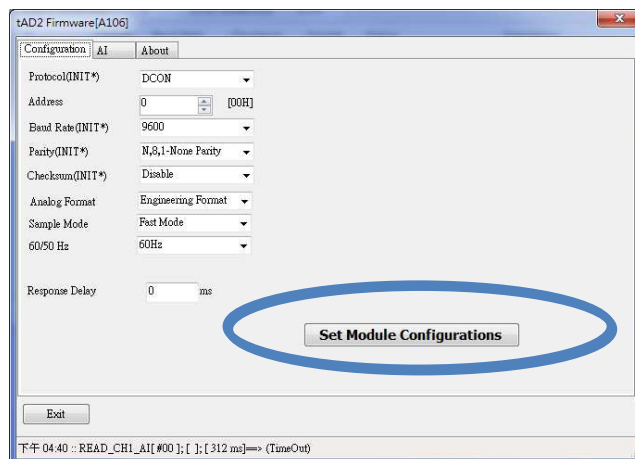

6 Rebooting the tM-Series Module in Normal Mode

Make sure the INIT switch is placed in the “Normal” position.

7 Starting the Module Operation

After rebooting the tM-Series module, search for the module to make sure the settings have been changed. You can double click on the name of the module in the list to open

the configuration dialog box.

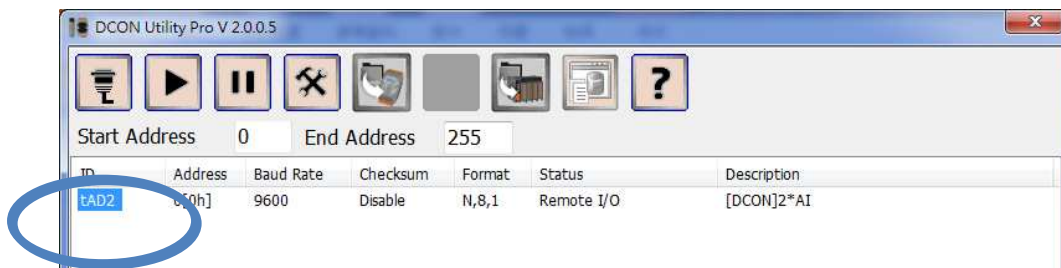

8 Modbus Address Mapping

Address	Description	Attribute																				
30001 ~ 30002 40001 ~ 40002	Analog input value of channel 0 to 1	R																				
40257 ~ 40258	Analog input type code of channel 0 to 1	R/W																				
40481	Firmware version (low word)	R																				
40482	Firmware version (high word)	R																				
40483	Module name (low word) , 0x2001	R																				
40484	Module name (high word) , 0x0700	R																				
40485	Module address, valid range: 1 ~ 247	R/W																				
40486	Bits 5:0 Baud rate, 0x03 ~ 0x0A <table border="1" style="margin-left: 20px;"> <tbody> <tr> <td>Code</td> <td>0x03</td> <td>0x04</td> <td>0x05</td> <td>0x06</td> </tr> <tr> <td>Baud</td> <td>1200</td> <td>2400</td> <td>4800</td> <td>9600</td> </tr> <tr> <td>Code</td> <td>0x07</td> <td>0x08</td> <td>0x09</td> <td>0x0A</td> </tr> <tr> <td>Baud</td> <td>19200</td> <td>38400</td> <td>57600</td> <td>115200</td> </tr> </tbody> </table> Bits 7:6 00: no parity, 1 stop bit 01: no parity, 2 stop bits 10: even parity, 1 stop bit 11: odd parity, 1 stop bit	Code	0x03	0x04	0x05	0x06	Baud	1200	2400	4800	9600	Code	0x07	0x08	0x09	0x0A	Baud	19200	38400	57600	115200	R/W
Code	0x03	0x04	0x05	0x06																		
Baud	1200	2400	4800	9600																		
Code	0x07	0x08	0x09	0x0A																		
Baud	19200	38400	57600	115200																		
40488	Modbus response delay time in ms, valid range: 0 ~ 30	R/W																				
40489	Host watchdog timeout value, 0 ~ 255, in 0.1s	R/W																				
40490	Channel enable/disable, 00h ~ 03h	R/W																				
40492	Host watchdog timeout count, write 0 to clear	R/W																				
40494	4mA under range threshold in 0.1mA, 0 ~ 40	R/W																				

Address	Description	Attribute
10129 ~ 10130 00129 ~ 00130	Over/under range status of channel 0 to 1 for 4 ~ 20mA or 0 ~ 20mA ranges	R
00257	Protocol, 0: DCON, 1: Modbus RTU	R/W
00258	Protocol, 0: determined by 00257, 1: Modbus ASCII	R/W
00261	1: enable, 0: disable host watchdog	R/W
00269	Modbus data format, 0: hex, 1: engineering	R/W
00270	Host watch dog timeout status, write 1 to clear host watch dog timeout status	R/W
00271	1: enable, 0: disable fast mode	R/W
00273	Reset status, 1: first read after powered on, 0: not the first read after powered on	R