

# I-7018Z, M-7018Z Quick Start Guide

## Warranty

All products manufactured by ICP DAS are under warranty regarding defective materials for a period of one year from the date of delivery to the original purchaser.

## Warning

ICP DAS assumes no liability for damages resulting from the use of this product. ICP DAS reserves the right to change this manual at any time without notification. The information furnished by ICP DAS is believed to be accurate and reliable. However, no responsibility is assumed by ICP DAS for its use, or for any infringements of patents or other rights of third parties resulting from its use.

## Packing List

	I-7018Z M-7018Z	DB-1820	DN-1822	CA-252518D	Plastic Rail	CD	Quick Start Guide
I-7018Z-G/S M-7018Z-G/S	V	V			V	V	V
I-7018Z-G/S2 M-7018Z-G/S2	V		V	V	V	V	V

## Internal I/O Structure

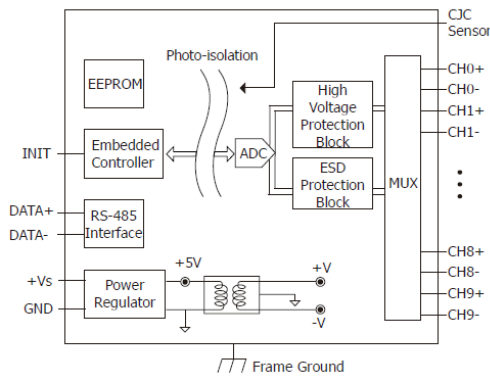

## Pin Assignments (CON1)

CON1			
Pin Assignment	Terminal	No.	Pin Assignment
+5V	01	14	AGND
CJC	02	15	CH 0+
CH 0-	03	16	CH 1+
CH 1-	04	17	CH 2+
CH 2-	05	18	CH 3+
CH 3-	06	19	CH 4+
CH 4-	07	20	CH 5+
CH 5-	08	21	CH 6+
CH 6-	09	22	CH 7+
CH 7-	10	23	CH 8+
CH 8-	11	24	CH 9+
CH 9-	12	25	N.C.
N.C.	13	Shield	F.G.

25-pin Female D-Sub Connector

## Pin Assignments

### I-7018Z/M-7018Z

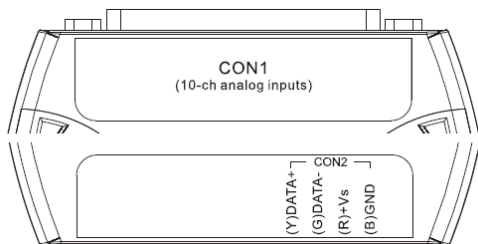

### DB-1820

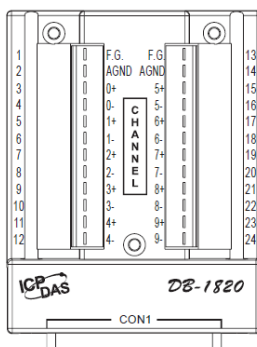

### DN-1822

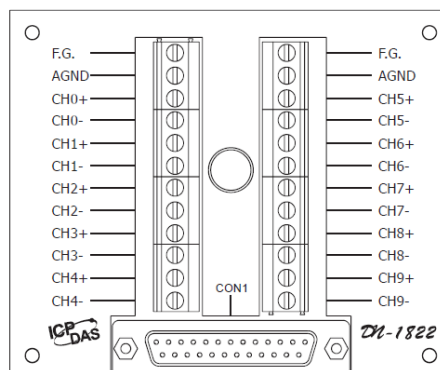

## ■ Wire Connections

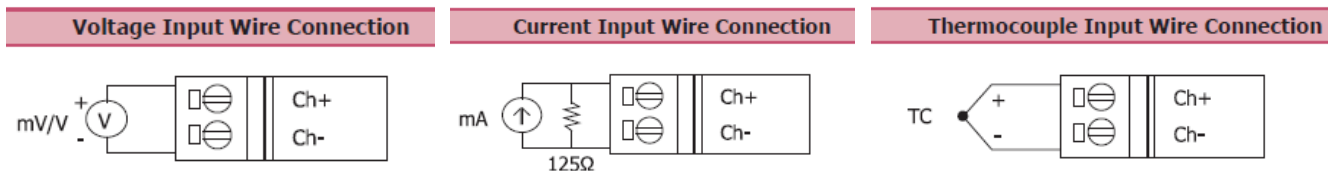

## ■ Modbus Table (M-7018Z only)

Address	Description	R/W																				
30001 ~ 30010	Analog input value of channel 0 to 9	R																				
40001 ~ 40010																						
30129	CJC temperature in 0.01°C	R																				
40129																						
40257 ~ 40266	Type code of channel 0 to 9	R/W																				
40353 ~ 40362	CJC offset of channel 0 to 9 in 0.1°C. 1 for 0.1, 127 for 12.7, 255 for -0.1, 128 for -12.8	R/W																				
40481	Firmware version (low word)	R																				
40482	Firmware version (high word)	R																				
40483	Module name (low word)	R																				
40484	Module name (high word)	R																				
40485	Module address, valid range: 1 ~ 247	R/W																				
40486	Bits 5:0 Baud rate, 0x03 ~ 0x0A <table border="1" style="margin-left: 20px;"> <thead> <tr> <th>Code</th> <th>0x03</th> <th>0x04</th> <th>0x05</th> <th>0x06</th> </tr> </thead> <tbody> <tr> <td>Baud</td> <td>1200</td> <td>2400</td> <td>4800</td> <td>9600</td> </tr> <tr> <th>Code</th> <th>0x07</th> <th>0x08</th> <th>0x09</th> <th>0x0A</th> </tr> <tr> <td>Baud</td> <td>19200</td> <td>38400</td> <td>57600</td> <td>115200</td> </tr> </tbody> </table> Bits 7:6 00: no parity, 1 stop bit 01: no parity, 2 stop bit 10: even parity, 1 stop bit 11: odd parity, 1 stop bit	Code	0x03	0x04	0x05	0x06	Baud	1200	2400	4800	9600	Code	0x07	0x08	0x09	0x0A	Baud	19200	38400	57600	115200	R/W
Code	0x03	0x04	0x05	0x06																		
Baud	1200	2400	4800	9600																		
Code	0x07	0x08	0x09	0x0A																		
Baud	19200	38400	57600	115200																		

Address	Description	R/W
40488	Modbus response delay time in ms, valid range: 0 ~ 30	R/W
40489	Host watchdog timeout value, 0 ~ 255, in 0.1s	R/W
40490	Channel enable/disable, 00h ~ 3FFh	R/W
40491	Module CJC offset in 0.01°C	R/W
40492	Host watchdog timeout count, write 0 to clear	R/W
00257	Protocol, 0: DCON, 1: Modbus RTU	R/W
00259	Filter setting, 0: 60Hz rejection, 1: 50Hz rejection	R/W
00260	Modbus host watchdog mode 0: same as I-7000 1: can use AO and DO command to clear host watchdog timeout status	
00261	1: enable, 0: disable host watchdog	R/W
00268	1: enable, 0: disable CJC	R/W
00269	Modbus data format, 0: hex, 1: engineering	R/W
00270	Host watch dog timeout status, write 1 to clear host watch dog timeout status	R/W
00273	Reset status, 1: first read after powered on, 0: not the first read after powered on	R

## ■ DCON Protocol

Functions	Command	Response	Notes
Read module name	\$AAM	!AA(Data)	AA: address number
Read module firmware version	\$AAF	!AA(Data)	
Read all analog input data	#aa	>(data)	
Read analog input data of each channel (<=16 channel)	#aai	>(data)	i: channel number (Hex)
Read analog input data of each channel (>16 channel)	#aaii	>(data)	ii: channel number (Hex)

If you want to know the detail DCON protocol, please check it from CD or web

CD path: \\napdos\7000>manual\

Web: <ftp://ftp.icpdas.com/pub/cd/8000cd/napdos/7000/manual/>

## Module test and configuration

### Step 1: INIT switch Operation

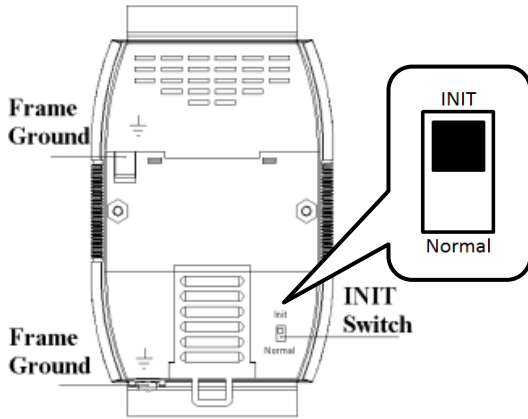

1. Find out the INIT switch( back of the module), and turn to INIT.
2. Reboot the module

### Step 2: Install & Run DCON Utility

1. Please Install DCON Utility first  
You can find the software in the CD.

CD path:

<Driver>:\napdos\driver\dcon\_utility\

Web link:

[http://ftp.icpdas.com/pub/cd/8000cd/napdos/driver/dcon\\_utility/](http://ftp.icpdas.com/pub/cd/8000cd/napdos/driver/dcon_utility/)

2. Run DCON utility



### Step 3: Set search configuration & search module

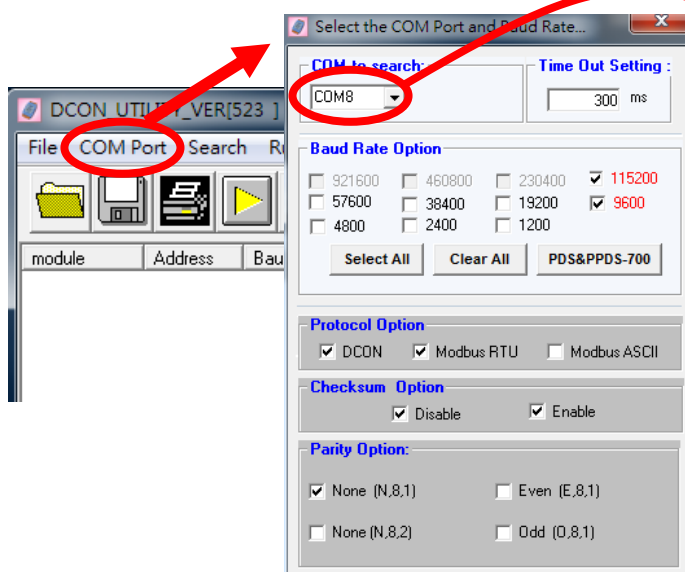

Select COM Port Number

1. Click "COM Port"
2. Assign the communication information and click "OK"

#### Module Default Setting

COM Port	Refer converter Port Number
Baud Rate	9600
Protocol	DCON for I-7000 Modbus RTU for M-7000
Parity Option	N,8,1

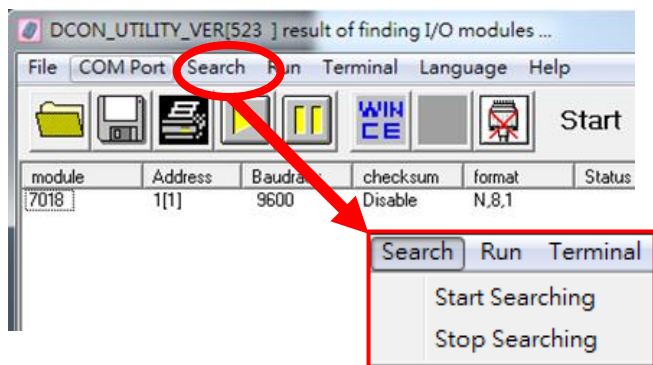

3. Click "Search" and select "Start Searching"  
Software will search the modules from COM Port
4. Click "Search" and select "stop searching"  
Manual stop when the modules searched

Note:

When no module can be searched, please check the wire and communication information

### Step 4: Select Module for testing and configuration

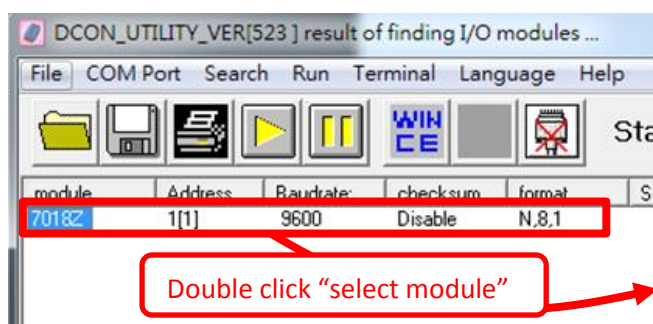

Double click "select module"

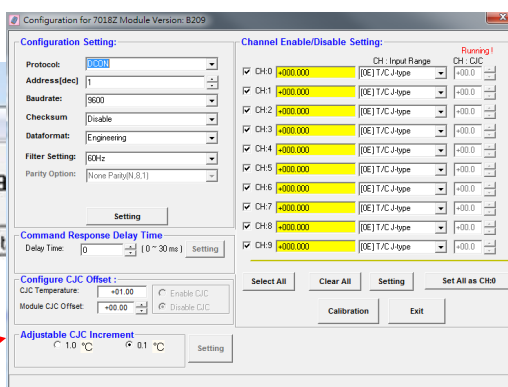

## Step 5: Configuration Settings & Channel Settings

Module Settings	
Protocol	DCON / Modbus
Address	1~255 (0:INIT)
Baud rate	1200~115200
Parity option	N,8,1

Channel Status  
Input Range Settings  
CJC offset

Temperature Offset Settings

## Step 6: Change to normal mode and keep the settings

1. Turn the INIT Switch to Normal.
2. Reboot the module



## Trouble Shooting

### Q1. How to do when forgot module address or baud rate?

Please turn to INIT mode, and run DCON Utility to search.  
The module supports DCON protocol at the INIT mode.  
And the address is 0. The communication setting is "9600,N,8,1".

### Q2. How to configure the I-7000 and M-7000 modules?

ICP DAS provide DCON Utility to configure I-7000 and M-7000 modules.  
Please download the last version from: [http://ftp.icpdas.com/pub/cd/8000cd/napdos/driver/dcon\\_utility/](http://ftp.icpdas.com/pub/cd/8000cd/napdos/driver/dcon_utility/)

### Q3. What is individual channel configuration?

I-7018Z and M-7018Z provide the "individual channel configuration".  
"Individual channel configuration" means the different settings of the input ranges for each channel.  
You can configure the modules by DCON utility

### Q4. What is the CJC function?

CJC (Cold-Junction Compensation) offset is for the temperature measurement.  
You can set a CJC offset for all channels or different channel in DCON Utility,

### Q5. How to programming with I-7000 or M-7000 by C#, VB, VC?

ICP DAS I-7000 and M-7000 series both support DCON protocol. And Only M-7000 series supports Modbus protocol.  
For DCON protocol, please download SDK and Demo from:  
[http://ftp.icpdas.com/pub/cd/8000cd/napdos/driver/dcon\\_dll\\_new/](http://ftp.icpdas.com/pub/cd/8000cd/napdos/driver/dcon_dll_new/)  
For Modbus protocol, please refer this web link:  
<http://www.icpdas.com/products/PAC/i-8000/modbus.htm>

If there is any other question, please feel free to contact us. Email: [service@icpdas.com](mailto:service@icpdas.com)  
Website: [http://www.icpdas.com.tw/contact\\_us/contact\\_us.html](http://www.icpdas.com.tw/contact_us/contact_us.html)