

# UG67 Gateway

User Guide

## Preface

Thanks for choosing Milesight UG67 LoRaWAN® gateway. UG67 delivers tenacious connection over network with full-featured design such as automated failover/failback, extended operating temperature, dual SIM cards, hardware watchdog, VPN, Gigabit Ethernet and beyond.

This guide shows you how to configure and operate the UG67 LoRaWAN® gateway. You can refer to it for detailed functionality and gateway configuration.

## Readers

This guide is mainly intended for the following users:

- Network Planners
- On-site technical support and maintenance personnel
- Network administrators responsible for network configuration and maintenance

© Xiamen Milesight IoT Co., Ltd.

**All rights reserved.**

All information in this user guide is protected by copyright law. Whereby, no organization or individual shall copy or reproduce the whole or part of this user guide by any means without written authorization from Xiamen Milesight IoT Co., Ltd.

## Related Documents

Document	Description
UG67 Datasheet	Datasheet for UG67 LoRaWAN® gateway.
UG67 Quick Start Guide	Quick Installation Guide for UG67 LoRaWAN® gateway.

## Declaration of Conformity

UG67 is in conformity with the essential requirements and other relevant provisions of the CE, FCC, and RoHS.



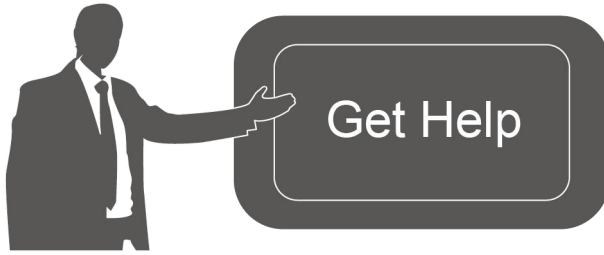

For assistance, please contact  
Milesight technical support:  
Email: [iot.support@milesight.com](mailto:iot.support@milesight.com)  
Tel: 86-592-5085280  
Fax: 86-592-5023065

### Revision History

Date	Doc Version	Description
Dec. 31, 2020	V1.0	Initial version

# Contents

<b>Chapter 1 Product Introduction</b> .....	<b>7</b>
<b>1.1 Overview</b> .....	<b>7</b>
<b>1.2 Advantages</b> .....	<b>7</b>
<b>1.3 Specifications</b> .....	<b>8</b>
<b>1.4 Dimensions (mm)</b> .....	<b>10</b>
<b>Chapter 2 Access to Web GUI</b> .....	<b>11</b>
<b>2.1 Wireless Access</b> .....	<b>11</b>
<b>2.2 Wired Access</b> .....	<b>12</b>
<b>Chapter 3 Web Configuration</b> .....	<b>15</b>
<b>3.1 Status</b> .....	<b>15</b>
<b>3.1.1 Overview</b> .....	<b>15</b>
<b>3.1.2 Packet Forwarder</b> .....	<b>16</b>
<b>3.1.3 Cellular</b> .....	<b>17</b>
<b>3.1.4 Network</b> .....	<b>19</b>
<b>3.1.5 WLAN</b> .....	<b>19</b>
<b>3.1.6 VPN</b> .....	<b>20</b>
<b>3.1.7 Host List</b> .....	<b>21</b>
<b>3.2 LoRaWAN</b> .....	<b>22</b>
<b>3.2.1 Packet Forwarder</b> .....	<b>23</b>
<b>3.2.1.1 General</b> .....	<b>23</b>
<b>3.2.1.2 Radios</b> .....	<b>24</b>
<b>3.2.1.3 Advanced</b> .....	<b>26</b>
<b>3.2.1.4 Custom</b> .....	<b>27</b>
<b>3.2.1.5 Traffic</b> .....	<b>27</b>
<b>3.2.2 Network Server</b> .....	<b>29</b>
<b>3.2.2.1 General</b> .....	<b>29</b>
<b>3.2.2.2 Application</b> .....	<b>31</b>
<b>3.2.2.3 Profiles</b> .....	<b>34</b>
<b>3.2.2.4 Device</b> .....	<b>37</b>
<b>3.2.2.5 Gateway</b> .....	<b>40</b>
<b>3.2.2.6 Packets</b> .....	<b>41</b>
<b>3.3 Network</b> .....	<b>44</b>
<b>3.3.1 Interface</b> .....	<b>44</b>
<b>3.3.1.1 Port</b> .....	<b>44</b>
<b>3.3.1.2 WLAN</b> .....	<b>47</b>
<b>3.3.1.3 Cellular</b> .....	<b>50</b>
<b>3.3.1.4 Loopback</b> .....	<b>53</b>
<b>3.3.2 Firewall</b> .....	<b>53</b>
<b>3.3.2.1 Security</b> .....	<b>54</b>
<b>3.3.2.2 ACL</b> .....	<b>54</b>
<b>3.3.2.3 DMZ</b> .....	<b>56</b>

3.3.2.4 Port Mapping.....	56
3.3.2.5 MAC Binding.....	57
3.3.3 DHCP.....	58
3.3.4 DDNS.....	59
3.3.5 Link Failover.....	60
3.3.5.1 SLA.....	60
3.3.5.2 Track.....	61
3.3.5.3 WAN Failover.....	62
3.3.6 VPN.....	63
3.3.6.1 DMVPN.....	63
3.3.6.2 IPsec.....	64
3.3.6.3 GRE.....	67
3.3.6.4 L2TP.....	68
3.3.6.5 PPTP.....	70
3.3.6.6 OpenVPN Client.....	72
3.3.6.7 OpenVPN Server.....	73
3.3.6.8 Certifications.....	75
3.4 System.....	77
3.4.1 General Settings.....	77
3.4.1.1 General.....	77
3.4.1.2 System Time.....	78
3.4.1.3 SMTP.....	80
3.4.1.4 Phone.....	80
3.4.1.5 Email.....	81
3.4.2 User Management.....	82
3.4.2.1 Account.....	82
3.4.2.2 User Management.....	83
3.4.3 SNMP.....	83
3.4.3.1 SNMP.....	84
3.4.3.2 MIB View.....	84
3.4.3.3 VACM.....	85
3.4.3.4 Trap.....	86
3.4.3.5 MIB.....	86
3.4.5 Device Management.....	87
3.4.6 Events.....	88
3.4.6.1 Events.....	88
3.4.6.2 Events Settings.....	89
3.5 Maintenance.....	90
3.5.1 Tools.....	90
3.5.1.1 Ping.....	90
3.5.1.2 Traceroute.....	90
3.5.2 Schedule.....	91
3.5.3 Log.....	91
3.5.3.1 System Log.....	91

3.5.3.2 Log Settings.....	92
3.5.4 Upgrade.....	93
3.5.5 Backup and Restore.....	94
3.5.6 Reboot.....	94
3.6 APP.....	95
3.6.1 Python.....	95
3.6.1.1 Python.....	96
3.6.1.2 App Manager Configuration.....	96
3.6.1.3 Python App.....	97
Chapter 4 Application Examples.....	98
4.1 Packet Forwarder Configuration.....	98
4.2 Application Configuration.....	99
4.3 Device Configuration.....	101
4.4 Send Data to Device.....	102
4.5 Restore Factory Defaults.....	105
4.5.1 Via Web Interface.....	105
4.5.2 Via Hardware.....	107
4.6 Firmware Upgrade.....	107
4.7 Cellular Connection.....	108
4.8 Wi-Fi Application Example.....	109
4.8.1 AP Mode.....	109
4.8.2 Client Mode.....	110

## Chapter 1 Product Introduction

### 1.1 Overview

UG67 is a robust 8-channel indoor LoRaWAN® gateway. Adopting SX1302 LoRa chip and high-performance quad-core CPU, UG67 supports connection with more than 2000 nodes. UG67 has line of sight up to 10km and can cover about 2km in urbanized environment, which is ideally suited to smart office, smart building and many other indoor applications.

UG67 supports not only multiple back-haul backups with Ethernet, Wi-Fi and cellular, but also has integrated mainstream network servers (such as TTN, ChirpStack, etc.) and built-in network server and Milesight IoT Cloud for easy deployment.

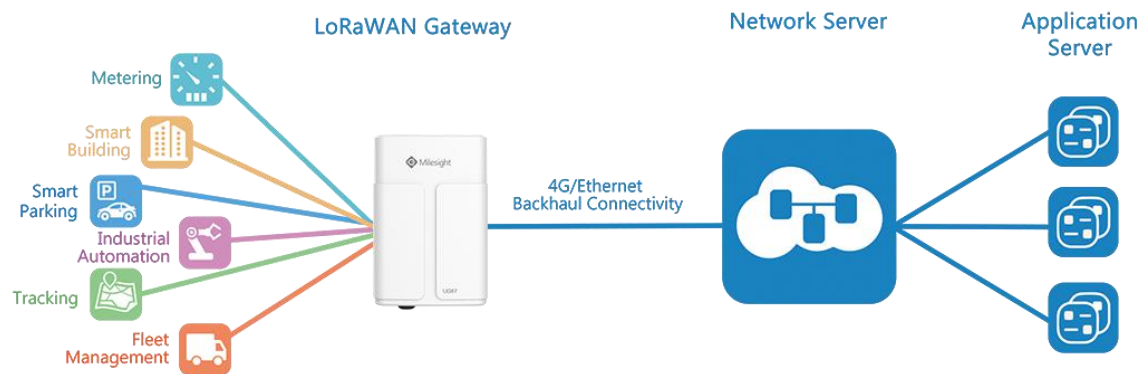

Figure 1-1

### 1.2 Advantages

#### Benefits

- Built-in industrial CPU and big memory;
- Ethernet, 2.4GHz Wi-Fi and global 2G/3G/LTE options make it easy to get connected
- Embedded network server and compliant with several third party network servers
- MQTT, HTTP or HTTPS protocol for data transmission to application server
- Rugged enclosure, optimized for wall or pole mounting
- 3-year warranty included

#### Security & Reliability

- Automated failover/failback between Ethernet and Cellular (dual SIM)
- Enable unit with security frameworks like IPsec/OpenVPN/GRE/L2TP/PPTP/ DMVPN
- Embedded hardware watchdog to automatically recover from various failure and ensure highest level of availability

## Easy Maintenance

- Milesight DeviceHub provides easy setup, mass configuration, and centralized management of remote devices
- The user-friendly web interface design and various upgrading options help administrator to manage the device as easy as pie
- WEB GUI and CLI enable the admin to achieve quick configuration and simple management among a large quantity of devices
- Users can efficiently manage the remote devices on the existing platform through the industrial standard SNMP

## Capabilities

- Link remote devices in an environment where communication technologies are constantly changing
- Industrial quad core 64-bit ARM Cortex-A53 processor, high-performance operating up to 1.5GHz with low power consumption, and 8GB eMMC available to support more applications
- Support wide operating temperature ranging from -40°C to 70°C/-40°F to 158°F

## 1.3 Specifications

Hardware System	
CPU	Quad-core 1.5GHz, 64-bit ARM Cortex-A53
Memory	8 GB eMMC Flash, 512 MB DDR4 RAM
LoRaWAN	
Antenna	2 × Internal Antennas + 2 × 50 Ω N-Female External Connectors
Channel	8
Frequency Band	CN470/IN865/EU868/RU864/US915/AU915/KR920/AS923
Sensitivity	-140dBm Sensitivity @292bps
Output Power	27dBm Max
Protocol	V1.0 Class A/Class C and V1.0.2 Class A/Class C
Ethernet	
Ports	1 × RJ-45 (PoE PD supported)
Physical Layer	10/100/1000 Base-T (IEEE 802.3)
Data Rate	10/100/1000 Mbps (auto-sensing)



Interface	Auto MDI/MDIX
Mode	Full or half duplex (auto-sensing)
<b>Wi-Fi Interfaces</b>	
Antenna	Fully Integrated and Internal Antenna
Standards	IEEE 802.11 b/g/n
Tx Power	802.11b: 18 dBm +/-2.0 dBm (11 Mbps)
	802.11g: 15 dBm +/-2.0 dBm (6 Mbps)
	802.11g: 15 dBm +/-2.0 dBm (54 Mbps)
	802.11n@2.4 GHz: 14 dBm +/-2.0 dBm (MCS0_HT20)
	802.11n@2.4 GHz: 14 dBm +/-2.0 dBm (MCS7_HT20)
	802.11n@2.4 GHz: 13 dBm +/-2.0 dBm (MCS0_HT40)
	802.11n@2.4 GHz: 13 dBm +/-2.0 dBm (MCS7_HT40)
<b>Cellular Interfaces (Optional)</b>	
Antenna	Internal Antenna
SIM Slots	1
<b>GPS</b>	
Antenna	Internal Antenna
Sensitivity	-167dBm@Tracking, -149dBm@Acquisition, -161dBm@Re-acquisition
Position Accuracy	<2.5m CEP
<b>Software</b>	
Network Protocols	PPPoE, SNMP v1/v2c/v3, TCP, UDP, DHCP, DDNS, HTTP, HTTPS, DNS, SNTP, Telnet, SSH, MQTT, etc.
VPN Tunnel	DMVPN/IPsec/OpenVPN/PPTP/L2TP/GRE
Access Authentication	CHAP/PAP/MS-CHAP/MS-CHAPV2
Firewall	ACL/DMZ/Port Mapping/MAC Binding
Management	Web, CLI, SMS, On-demand dial up
<b>Power Supply and Consumption</b>	
Power Supply	1. 1 × 802.3 af PoE Input
	2. 12 VDC with M12 Connector
Consumption	Typical 3.6W, Max 4.8W
<b>Physical Characteristics</b>	
Ingress Protection	IP67
Dimensions	250 x 172 x 92 mm

Mounting	Wall or Pole Mounting
<b>Others</b>	
Reset Button	1 × RST
LED Indicators	1 × SYS, 1 × LoRa, 1 × LTE
Built-in	Watchdog, RTC, Timer
<b>Environmental</b>	
Operating Temperature	-40°C to +70°C (-40°F to +158°F)
Storage Temperature	Reduced cellular performance above 60°C
Ethernet Isolation	1.5 kV RMS
Relative Humidity	0% to 95% (non-condensing) at 25°C/77°F

### 1.4 Dimensions (mm)

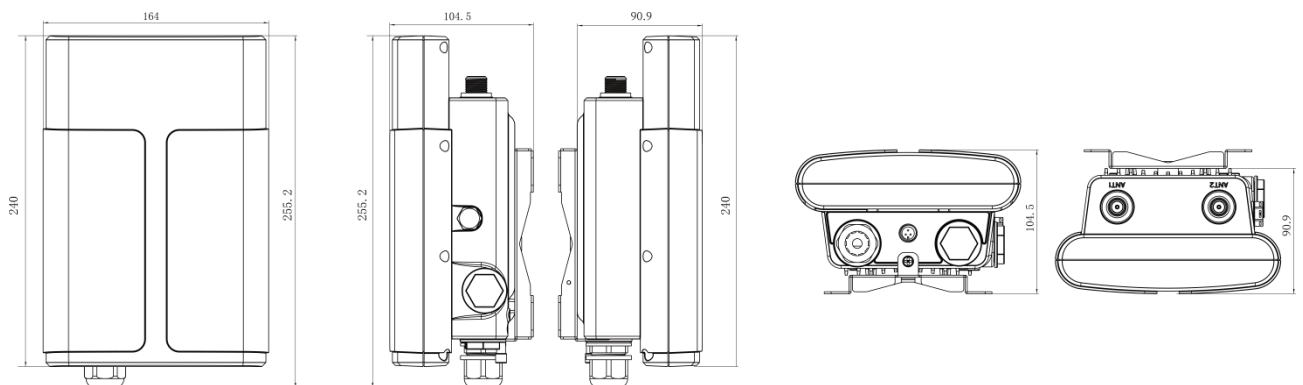

## Chapter 2 Access to Web GUI

This chapter explains how to access to Web GUI of the UG67.

### 2.1 Wireless Access

1. Enable Wireless Network Connection on your computer and search for access point "Gateway\_\*\*\*\*\*" to connect it.
2. Open a Web browser on your PC (Chrome is recommended) and type in the IP address 192.168.1.1 to access the web GUI.
3. Enter the username and password, click "Login".

English

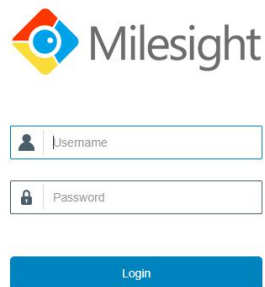

The login page features the Milesight logo at the top center. Below it are two input fields: one for 'Username' with a person icon and one for 'Password' with a lock icon. A blue 'Login' button is positioned below the password field.



**If you enter the username or password incorrectly more than 5 times, the login page will be locked for 10 minutes.**

4. After logging the web GUI, follow the guide to complete the basic configurations. You can also skip the instructions. It's suggested that you change the password for the sake of security.

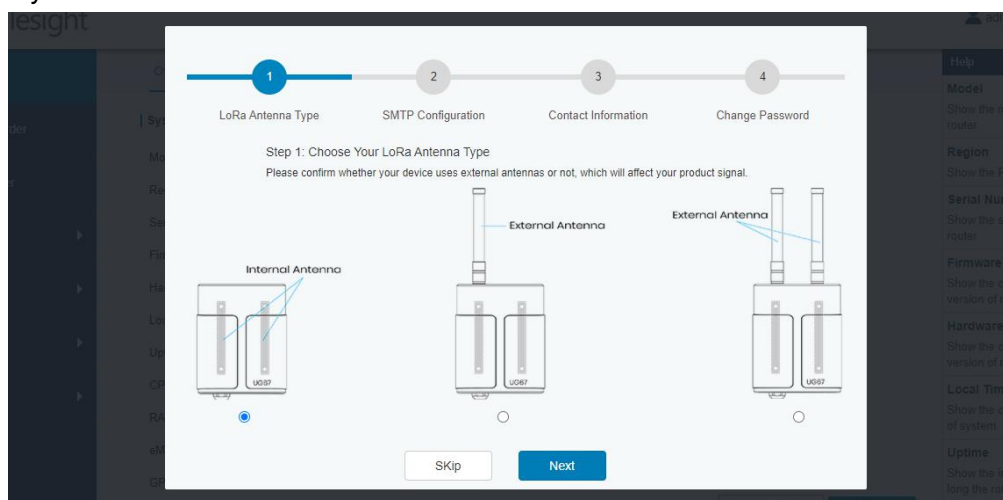

5. You can view system information and perform configuration of the gateway.

The screenshot displays the Milesight IoT web interface. At the top, there is a navigation bar with tabs for Overview, Packet Forward, Cellular, Network, WLAN, VPN, and Host List. A sidebar on the left contains menu items: Status, Packet Forwarder, Network Server, Network, System, Maintenance, and APP. The main content area is titled "System Information" and lists various system parameters:

Parameter	Value
Model	UG67-L00E-470M
Region	CN470
Serial Number	6222A3243835
Firmware Version	60.0.0.23
Hardware Version	V1.0
Local Time	2020-12-14 17:05:05 Monday
Uptime	4days,05:52:48
CPU Load	2%
RAM (Capacity/Available)	512MB/77MB(15.04%)
eMMC (Capacity/Available)	3.0G/2.7G(89.74%)
GPS	-

At the bottom right of the System Information section, there are buttons for "Manual Refresh" and "Refresh". A help sidebar on the right side of the page provides descriptions for various system parameters.

## 2.2 Wired Access

Connect PC to UG67 ETH port directly or through PoE injector to access the web GUI of gateway. The following steps are based on Windows 10 system for your reference.

1. Go to "Control Panel" → "Network and Internet" → "Network and Sharing Center", then click "Ethernet" (May have different names).

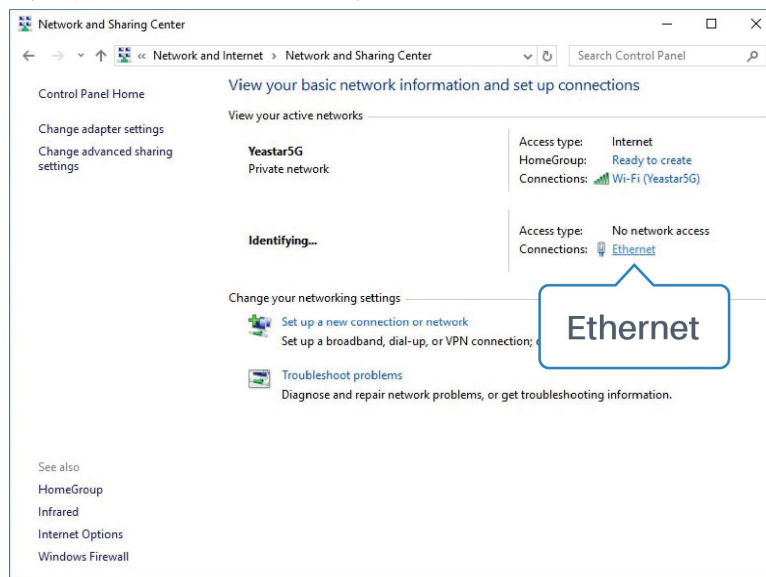

2. Go to "Properties" → "Internet Protocol Version 4(TCP/IPv4)" and select "Use the following IP address", then assign a static IP manually within the same subnet of the gateway.

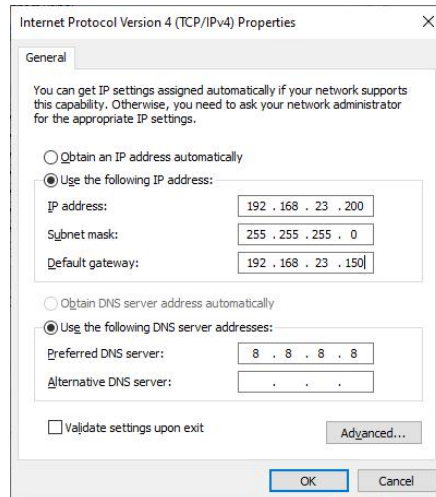

3. Open a Web browser on your PC (Chrome is recommended) and type in the IP address 192.168.23.150 to access the web GUI.
4. Enter the username and password, click "Login".

English



Username

Password

Login

**!** If you enter the username or password incorrectly more than 5 times, the login page will be locked for 10 minutes.

5. After logging the web GUI, follow the guide to complete the basic configurations. You can also skip the instructions. It's suggested that you change the password for the sake of security.

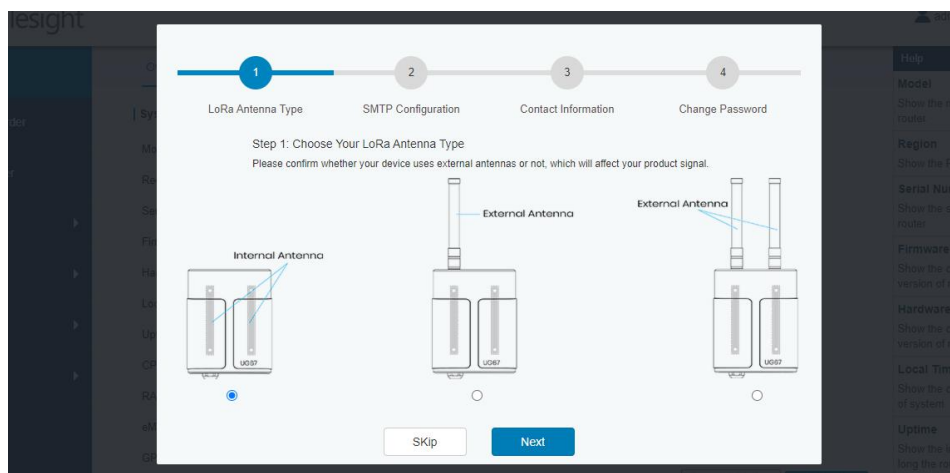

6. After guide complete, you can view system information and perform configuration of the gateway.

The screenshot shows the Milesight IoT gateway management interface. At the top, there is a navigation bar with the Milesight logo, a user profile for 'admin', and a refresh icon. Below this is a warning banner: "For your device security, please change the default password". The main interface is divided into a left sidebar with menu items (Status, Packet Forwarder, Network Server, Network, System, Maintenance, APP) and a main content area. The main content area has tabs for Overview, Packet Forward, Cellular, Network, WLAN, VPN, and Host List. The 'Overview' tab is active, displaying 'System Information' with a table of device details. A 'Help' sidebar is visible on the right, providing descriptions for various system parameters. At the bottom right of the system information table, there are 'Manual Refresh' and 'Refresh' buttons.

System Information	
Model	UG67-L00E-470M
Region	CN470
Serial Number	6222A3243835
Firmware Version	60.0.0.23
Hardware Version	V1.0
Local Time	2020-12-14 17:05:05 Monday
Uptime	4days,05:52:48
CPU Load	2%
RAM (Capacity/Available)	512MB/77MB(15.04%)
eMMC (Capacity/Available)	3.0G/2.7G(89.74%)
GPS	-

## Chapter 3 Web Configuration

### 3.1 Status

#### 3.1.1 Overview

You can view the system information of the gateway on this page.

Overview	Packet Forward	Cellular	Network
<b>System Information</b>			
Model		UG67-L00E-915M	
Region		US915	
Serial Number		6222A4983306	
Firmware Version		60.0.0.33	
Hardware Version		V1.1	
Local Time		2021-01-06 10:37:17 Wednesday	
Uptime		01:12:19	
CPU Load		7%	
RAM (Capacity/Available)		512MB/146MB(28.52%)	
eMMC (Capacity/Available)		3.0G/2.8G(90.66%)	
GPS		-	

Figure 3-1-1-1

System Information	
Item	Description
Model	Show the model name of gateway.
Region	Show the LoRaWAN <sup>®</sup> frequency region of gateway.
Serial Number	Show the serial number of gateway.
Firmware Version	Show the currently firmware version of gateway.
Hardware Version	Show the currently hardware version of gateway.
Local Time	Show the currently local time of system.
Uptime	Show the information on how long the gateway has been running.
CPU Load	Show the current CPU utilization of the gateway.
RAM (Capacity/Available)	Show the RAM capacity and the available RAM memory.
eMMC (Capacity/Available)	Show the eMMC capacity and the available eMMC memory.

GPS	Show GPS data of the gateway.
-----	-------------------------------

Table 3-1-1-1 System Information

### 3.1.2 Packet Forwarder

You can view the packet forward status of gateway on this page.

Overview	Packet Forward	Cellular	Network	WLAN
<b>Basic</b>				
Version	4.0.1			
Status	Connected			
Gateway ID	24E124FFFEF0E225			
Region Code	CN470			
<b>Uplink</b>				
Packet Received	0			
Packets Received State	CRC_OK: 0.00%, CRC_FAIL:			
Packet Forwarded	0 (0 bytes)			
Push Data Datagrams Sent	1 (133 bytes)			
Push Data Acknowledged	100.00%			
<b>Downlink</b>				
Pull Data Sent	3 (100.00% acknowledged)			
Pull Resp Datagrams Received	0 (0 bytes)			
Packets Sent to node	0 (0 bytes)			

Figure 3-1-2-1

Packet Forwarder Status	
Item	Description
<b>Basic</b>	
Version	Show the version of packet forwarder software.
Status	Show the status of packet forwarder.
Gateway ID	Show the ID of the gateway.
Region Code	Show the LoRa region code which is based on the gateway's variant.
<b>Uplink</b>	
Packet Received	Show the count of data packet from node to gateway.
Packets received State	Show the RF packets receiving state: CRC_OK: Percentage of CRC verification



	<p>CRC_Fail: Percentage of CRC verification failure</p> <p>NO_CRC: Percentage of abnormal packets without CRC</p>
Packets Forwarded	Packets that CRC verified are sent from gateway to server.
Push Data Datagrams Sent	The total quantity of packets sent from gateway to server, including the RF packets forwarded and statistics packets.
Push Data Acknowledged	Percentage of acknowledged packets among Push Data Datagrams Sent.
<b>Downlink</b>	
Pull Data Sent	Show the number of keepalive packets sent to the server, and percentage of acknowledged packet regarding the keepalive packet from the server.
Pull Resp Datagrams Received	Show the packet counts and size that will be sent from server to gateway.
Packets Sent to node	Show the RF packet counts and size that will be sent from gateway to node.
Packets Sent Errors	Show the RF packet counts that fail to be sent from server to node.

Table 3-1-2-1 LoRaWAN Status

### 3.1.3 Cellular

You can view the cellular network status of gateway on this page.

Overview	Packet Forward	Cellular	Network	WLAN
<b>Modem</b>				
Status	Ready			
Model	EC25			
Version	EC25ECGAR06A07M1G			
Signal Level	26asu (-61dBm)			
Register Status	Registered (Home network)			
IMEI	860425047368939			
IMSI	460019425301842			
ICCID	89860117838009934120			
ISP	CHN-UNICOM			
Network Type	LTE			
PLMN ID				
LAC	5922			
Cell ID	340db80			

Figure 3-1-3-1

Modem Information	
Item	Description
Status	Show corresponding detection status of module and SIM card.
Model	Show the model name of cellular module.
Version	Show the version of cellular module.
Signal Level	Show the cellular signal level.
Register Status	Show the registration status of SIM card.
IMEI	Show the IMEI of the module.
IMSI	Show IMSI of the SIM card.
ICCID	Show ICCID of the SIM card.
ISP	Show the network provider which the SIM card registers on.
Network Type	Show the connected network type, such as LTE, 3G, etc.
PLMN ID	Show the current PLMN ID, including MCC, MNC, LAC and Cell ID.
LAC	Show the location area code of the SIM card.
Cell ID	Show the Cell ID of the SIM card location.

Table 3-1-3-1 Modem Information

Network	
Status	Connected
IP Address	10.53.241.18
Netmask	255.255.255.252
Gateway	10.53.241.17
DNS	218.104.128.106
Connection Duration	0 days, 00:04:26

Figure 3-1-3-2

Network Status	
Item	Description
Status	Show the connection status of cellular network.
IP Address	Show the IP address of cellular network.
Netmask	Show the netmask of cellular network.
Gateway	Show the gateway of cellular network.
DNS	Show the DNS of cellular network.
Connection Duration	Show information on how long the cellular network has been connected.

Table 3-1-3-2 Network Status

### 3.1.4 Network

On this page you can check the Ethernet port status of the gateway.

Overview	Packet Forward	Cellular	Network	WLAN	VPN	Host List	
WAN							
Port	Status	Type	IP Address	Netmask	Gateway	DNS	Duration
eth 0	up	Static	192.168.23.202	255.255.255.0	192.168.23.1	8.8.8.8	07m 25s

Figure 3-1-4-1

Network	
Item	Description
Port	Show the name of the Ethernet port.
Status	Show the status of the Ethernet port. "Up" refers to a status that WAN is enabled and Ethernet cable is connected. "Down" means Ethernet cable is disconnected or WAN function is disabled.
Type	Show the dial-up type of the Ethernet port.
IP Address	Show the IP address of the Ethernet port.
Netmask	Show the netmask of the Ethernet port.
Gateway	Show the gateway of the Ethernet port.
DNS	Show the DNS of the Ethernet port.
Duration	Show the information about how long the Ethernet cable has been connected to the Ethernet port when the port is enabled. Once the port is disabled or Ethernet cable is disconnected, the duration will stop.

Table 3-1-4-1 WAN Status

### 3.1.5 WLAN

You can check Wi-Fi status on this page, including the information of access point and client.

Overview	Packet Forward	Cellular	Network	WLAN
WLAN Status				
Wireless Status	Enabled			
MAC Address	24:e1:24:f0:e2:26			
Interface Type	AP			
SSID	Gateway_F0E226			
Channel	Auto			
Encryption Type	No Encryption			
Status	Up			
IP Address	192.168.2.1			
Netmask	255.255.255.0			
Connection Duration	0 days, 00:20:59			

Figure 3-1-5-1

WLAN Status	
Item	Description
Wireless Status	Show the wireless status.
MAC Address	Show the MAC address.
Interface Type	Show the interface type, such as "AP" or "Client".
SSID	Show the SSID.
Channel	Show the wireless channel.
Encryption Type	Show the encryption type.
Status	Show the connection status.
IP Address	Show the IP address of the gateway.
Netmask	Show the wireless MAC address of the gateway.
Gateway	Show the gateway address in wireless network.
Connection Duration	Show information on how long the Wi-Fi network has been connected.

Table 3-1-5-1 WLAN Status

Associated Stations		
IP Address	MAC Address	Connection Duration

Figure 3-1-5-2

Associated Stations	
Item	Description
IP Address	Show the IP address of access point or client.
MAC Address	Show the MAC address of the access point or client.
Connection Duration	Show information on how long the Wi-Fi network has been connected.

Table 3-1-5-2 WLAN Status

### 3.1.6 VPN

You can check VPN status on this page, including PPTP, L2TP, IPsec, OpenVPN and DMVPN.

Overview	Packet Forward	Cellular	Network	WLAN	VPN	Host List
PPTP Tunnel						
Name	Status	Local IP	Remote IP			
pptp_1	Disconnected	-	-			
pptp_2	Disconnected	-	-			
pptp_3	Disconnected	-	-			
L2TP Tunnel						
Name	Status	Local IP	Remote IP			
l2tp_1	Disconnected	-	-			
l2tp_2	Disconnected	-	-			
l2tp_3	Disconnected	-	-			

Figure 3-1-6-1

IPsec Tunnel			
Name	Status	Local IP	Remote IP
ipsec_1	Disconnected	-	-
ipsec_2	Disconnected	-	-
ipsec_3	Disconnected	-	-

OpenVPN Client			
Name	Status	Local IP	Remote IP
openvpn_1	Disconnected	-	-
openvpn_2	Disconnected	-	-
openvpn_3	Disconnected	-	-

Figure 3-1-6-2

GRE Tunnel			
Name	Status	Local IP	Remote IP
gre_1	Disconnected	-	-
gre_2	Disconnected	-	-
gre_3	Disconnected	-	-

DMVPN Tunnel			
Name	Status	Local IP	Remote IP
dmvpn	Disconnected	-	-

Figure 3-1-6-3

VPN Status	
Item	Description
Name	Show the name of the VPN tunnel.
Status	Show the status of the VPN tunnel.
Local IP	Show the local tunnel IP of VPN tunnel.
Remote IP	Show the remote tunnel IP of VPN tunnel.

Table 3-1-6-1 VPN Status

### 3.1.7 Host List

You can view the host information on this page.

Overview	Packet Forward	Cellular	Network	WLAN	VPN	Host List
<b>DHCP Leases</b>						
IP		MAC		Lease Remaining Time		
<b>MAC Binding</b>						
IP		MAC				

Figure 3-1-7-1

Host List	
Item	Description
<b>DHCP Leases</b>	
IP Address	Show IP address of DHCP client
MAC Address	Show MAC address of DHCP client
Lease Time Remaining	Show the remaining lease time of DHCP client.
<b>MAC Binding</b>	
IP & MAC	Show the IP address and MAC address set in the Static IP list of DHCP service.

Table 3-1-7-1 Host List Description

### 3.2 LoRaWAN

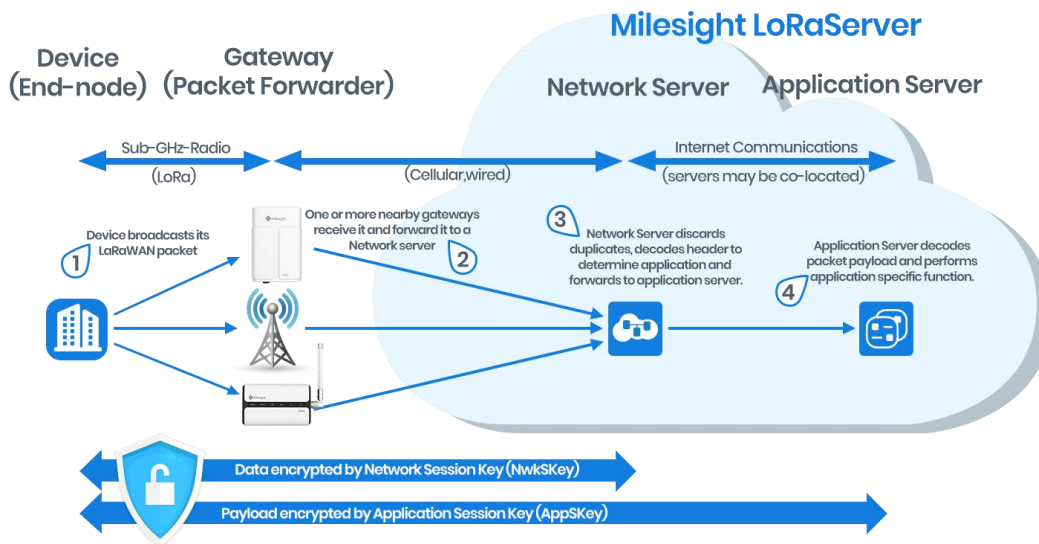

### 3.2.1 Packet Forwarder

#### 3.2.1.1 General

ID	Enable	Type	Server Address	Operation
0	Enabled	Milesight	localhost	

Figure 3-2-1-1

General Settings		
Item	Description	Default
Gateway EUI	Show the identifier of the gateway.	Generated from MAC address of the gateway and cannot be changed.
Gateway ID	Fill in the corresponding ID which you've used for register gateway on the remote network server, such as TTN. It is usually the same as gateway EUI and can be changed.	The same as gateway EUI.
Frequency-Sync	Sync frequency configurations from network server by selecting the corresponding ID.	Disabled
Multi-Destination	The gateway will forward the data to the network server address that was created and enabled in the list.	Local host

Table 3-2-1-1 General Setting Parameters

#### Related Configuration Example

[Packet forwarder configuration](#)

### 3.2.1.2 Radios



Figure 3-2-1-2

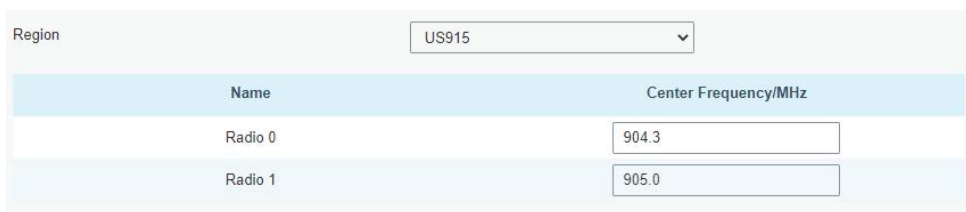

Figure 3-2-1-3

Radios-Radio Channel Setting		
Item	Description	Default
Antenna Type	Select the transmission type of antennas.	Internal Antenna
Region	Choose the LoRaWAN® frequency plan used for the upstream and downlink frequencies and datarates. Available channel plans depend on the gateway's model.	Based on the gateway's model
Center Frequency	Radio 0 : supports transmitting and receiving packet. Radio 1 : only supports receiving packet from nodes.	Based on what is specified in the LoRaWAN® regional parameters document

Table 3-2-1-2 Radio Channels Setting Parameters

Multi Channels Setting			
Enable	Index	Radio	Frequency/MHz
<input checked="" type="checkbox"/>	0	Radio 0	923.2
<input checked="" type="checkbox"/>	1	Radio 0	923.4
<input checked="" type="checkbox"/>	2	Radio 0	923.6
<input checked="" type="checkbox"/>	3	Radio 1	922.2
<input checked="" type="checkbox"/>	4	Radio 1	922.4
<input checked="" type="checkbox"/>	5	Radio 1	922.6
<input checked="" type="checkbox"/>	6	Radio 1	922.8
<input checked="" type="checkbox"/>	7	Radio 1	923.0



Figure 3-2-1-4

Radios-Multi Channel Setting		
Item	Description	Default
Enable	Click to enable this channel to transmit packets.	Enabled
Index	Indicate the ordinal of the list.	/
Radio	Choose Radio 0 or Radio 1 as center frequency.	Radio 0
Frequency/MHz	Enter the frequency of this channel. Range: center frequency $\pm 0.9$ .	Based on the LoRaWAN <sup>®</sup> regional document

Table 3-2-1-3 Multi Channel Setting Parameters

LoRa Channel Setting

Enable	Radio	Frequency/MHz	Bandwidth/KHz	Spread Factor
<input checked="" type="checkbox"/>	Radio 0	923.8	250KHZ	SF7

Figure 3-2-1-5

Radios-LoRa Channel Setting		
Item	Description	Default
Enable	Click to enable this channel to transmit packets.	Enabled
Radio	Choose Radio 0 or Radio 1 as center frequency.	Radio 0
Frequency/MHz	Enter the frequency of this channel. Range: center frequency $\pm 0.9$ .	Based on the supported frequency
Bandwidth/MHz	Enter the bandwidth of this channel. Recommended value: 125KHz, 250KHz, 500KHz	500KHz
Spread Factor	Choose the selectable spreading factor. The channel with large spreading factor corresponds to a low rate, while the small one corresponds to a high rate.	Based on what is specified in the LoRaWAN <sup>®</sup> regional parameters document

Table 3-2-1-4 LoRa Channel Setting Parameters

FSK Channel Setting

Enable	Radio	Frequency/MHz	Bandwidth/KHz	DataRate
<input checked="" type="checkbox"/>	Radio 0	924.0	125KHZ	50000

Figure 3-2-1-6

Radios-FSK Channel Setting		
Item	Description	Default
Enable	Click to enable this channel to transmit packets.	Disabled

Radio	Choose Radio 0 or Radio 1 as center frequency.	Radio 0
Frequency/MHz	Enter the frequency of this channel. Range: center frequency $\pm$ 0.9.	Based on the supported frequency
Bandwidth/MHz	Enter the bandwidth of this channel. Recommended value: 125KHz, 250KHz, 500KHz	Based on the supported frequency
Data Rate	Enter the data rate. Range: 500-25000.	500

Table 3-2-1-5 FSK Channel Setting Parameters

### 3.2.1.3 Advanced

Figure 3-2-1-7

Advanced		
Item	Description	Default
Keep Alive Interval	Enter the interval of keepalive packet which is sent from gateway to network server to keep the connection stable and alive. Range: 1-3600.	10
Stat Interval	Enter the interval to update the network server with gateway statistics. Range: 1-3600.	30
Push Timeout	Enter the timeout to wait for the response from server after the gateway sends data of node. Rang: 1-1999.	100
Forward CRC Disabled	Enable to send packets received with CRC disabled to the network server.	Disabled
Forward CRC	Enable to send packets received with CRC errors to	Disabled

Error	the network server.	
Forward CRC Valid	Enable to send packets received with CRC valid to the network server.	Enabled

Table 3-2-1-6 Advanced Parameters

### 3.2.1.4 Custom

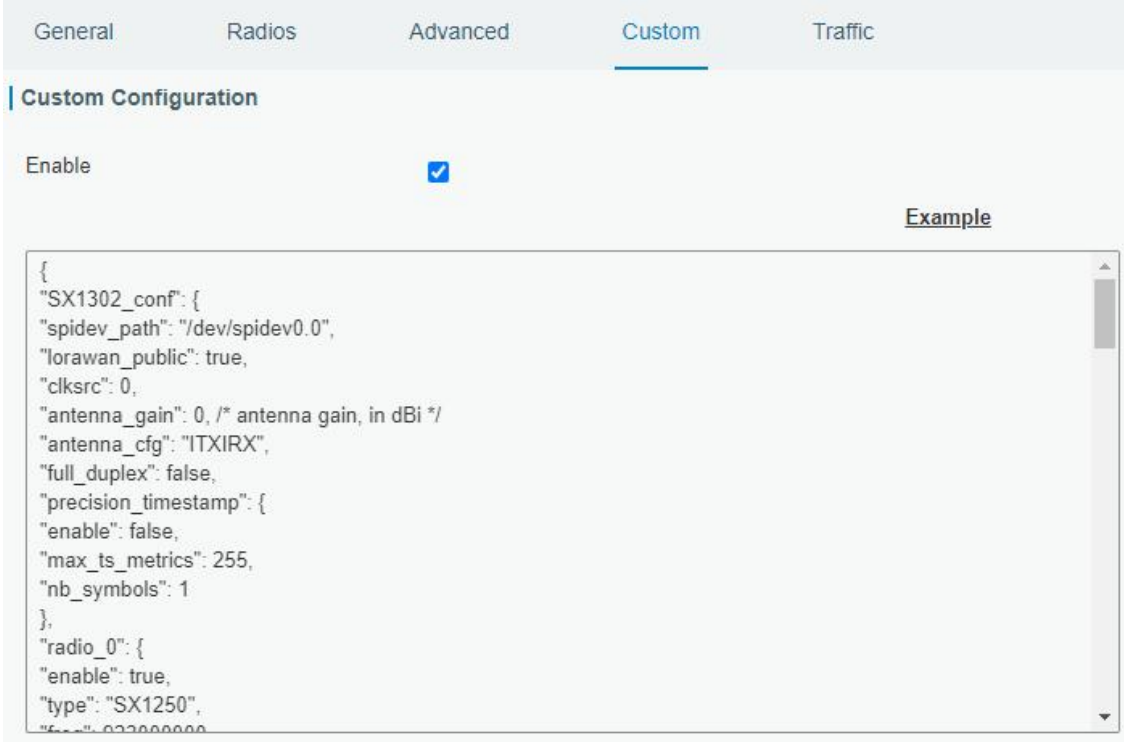

The screenshot shows the 'Custom' configuration tab in the Milesight IoT interface. The 'Enable' checkbox is checked. An 'Example' button is located to the right of the configuration area. Below the checkbox, a code editor displays the following JSON configuration:

```
{
  "SX1302_conf": {
    "spidev_path": "/dev/spidev0.0",
    "lorawan_public": true,
    "clksrc": 0,
    "antenna_gain": 0, /* antenna gain, in dBi */
    "antenna_cfg": "ITXIRX",
    "full_duplex": false,
    "precision_timestamp": {
      "enable": false,
      "max_ts_metrics": 255,
      "nb_symbols": 1
    },
  },
  "radio_0": {
    "enable": true,
    "type": "SX1250",
    "freq": 863000000
  }
}
```

Figure 3-2-1-8

When Custom Configuration mode is enabled, you can write your own packet forwarder configuration file in the edit box to configure packet forwarder. Click “Save” to save your custom configuration file content, and click “Apply” to take effect. You can click “Clear” to erase all content in the edit box. If you don’t know how to write configuration file, please click “Example” to go to reference page.

### 3.2.1.5 Traffic

When navigating to the traffic page, any recent traffic received by the gateway will display. To watch live traffic, click Start.

Traffic Setting

Refresh Clear

Rfch	Direction	Time	Ticks	Frequency	Datarate	Coderate	RSSI	SNR
1	up	-	83002508	922.8	SF9BW125	4/5	-103	-13.2
1	up	-	71108156	922.6	SF9BW125	4/5	-102	-13.2
1	up	-	35426956	922.8	SF9BW125	4/5	-103	-9.8
1	up	-	3171639508	922.6	SF9BW125	4/5	-100	-10.5
1	up	-	3159744804	922.6	SF9BW125	4/5	-102	-13.0
1	up	-	3155781348	922.6	SF9BW125	4/5	-101	-12.2
1	up	-	3147851660	922.6	SF9BW125	4/5	-102	-13.8
1	up	-	3143888916	922.8	SF9BW125	4/5	-102	-13.2
1	up	-	3139922740	922.8	SF9BW125	4/5	-100	-12.2
1	up	-	3124065788	922.8	SF9BW125	4/5	-100	-12.8

Figure 3-2-1-9

Item	Description
Refresh	Click to obtain the latest data.
Clear	Click to clear all data.
Rfch	Show the channel of this packet.
Direction	Show the direction of this packet.
Time	Show the receiving time of this packet.
Ticks	Show the ticks of this packet.
Frequency	Show the frequency of the channel.
Datarate	Show the datarate of the channel.
Coderate	Show the coderate of this packet.
RSSI	Show the received signal strength.
SNR	Show the signal to noise ratio of this packet.

Table 3-2-1-7 Traffic Parameters

### 3.2.2 Network Server

#### 3.2.2.1 General

Figure 3-2-2-1

Item	Description	Default
<b>General Setting</b>		
Enable	Click to enable Network Server mode.	Enabled
Milesight IoT Cloud	Enabled to connect gateway to Milesight IoT Cloud.	Disabled
NetID	Enter the network identifier.	010203
Join Delay	Enter the interval time between when the end-device sends a Join_request_message to network server and when the end-device prepares to open RX1 to receive the Join_accept_message sent from network server.	5
RX1 Delay	Enter the interval time between when the end-device sends uplink packets and when the end-device prepares to open RX1 to receive the downlink packet.	1
Lease Time	Enter the amount of time till a successful join expires. The format is hours-minutes-seconds. If the join-type is OTAA, then the end-devices need to join the network server again when it	876000-00-00

	exceeds the lease time.	
Log level	Choose the log level.	Info
<b>Channel Plan Setting</b>		
Channel Plan	Choose LoRaWAN® channel plan used for the upstream and downlink frequencies and datarates. Available channel plans depend on the gateway's model.	Depend on the gateway's model
Channel Mask	<p>Enabled frequencies are controlled using channel mask. Leave it blank means using all the default standard usable channels specified in the LoRaWAN® regional parameters document.</p> <p>A bit in the ChMask field set to 1 means that the corresponding channel can be used for uplink transmissions if this channel allows the data rate currently used by the end-device.</p> <p>A bit set to 0 means the corresponding channels should be avoided.</p> <p>US 915 and AU 915 have a 80-bit channel mask for 72 usable channels and EU, AS, IN, KR frequencies have a 16-bit mask for 16 usable channels.</p>	Depend on the gateway's model

Table 3-2-2-1 General Parameters

**Note:** For some regional variants, if allowed by your LoRaWAN® region, you can use Additional Plan to configure additional channels undefined by the LoRaWAN® Regional Parameters, like EU868 and KR920, as the following picture shows:

Frequency(MHz)	Min Datarate	Max Datarate	Operation
			+

Figure 3-2-2

Additional Channels		
Item	Description	Default
Frequency/MHz	Enter the frequency of the additional plan.	Null.
Max Datarate	Enter the max datarate for the end-device. The range is based on what is specified in the LoRaWAN® regional parameters document.	DR0(SF12,125kHz)
Min Datarate	Enter the min datarate for the end-device.	DR3(SF9,125kHz)

	The range is based on what is specified in the LoRaWAN® regional parameters document.	
--	---------------------------------------------------------------------------------------	--

Table 3-2-2-2 Additional Plan Parameters

### 3.2.2.2 Application

An application is a collection of devices with the same purpose/of the same type. All devices with the same “Payload Codec” and data transmission destination can be added under the same application.

You can edit the application by clicking  or create a new application by clicking .

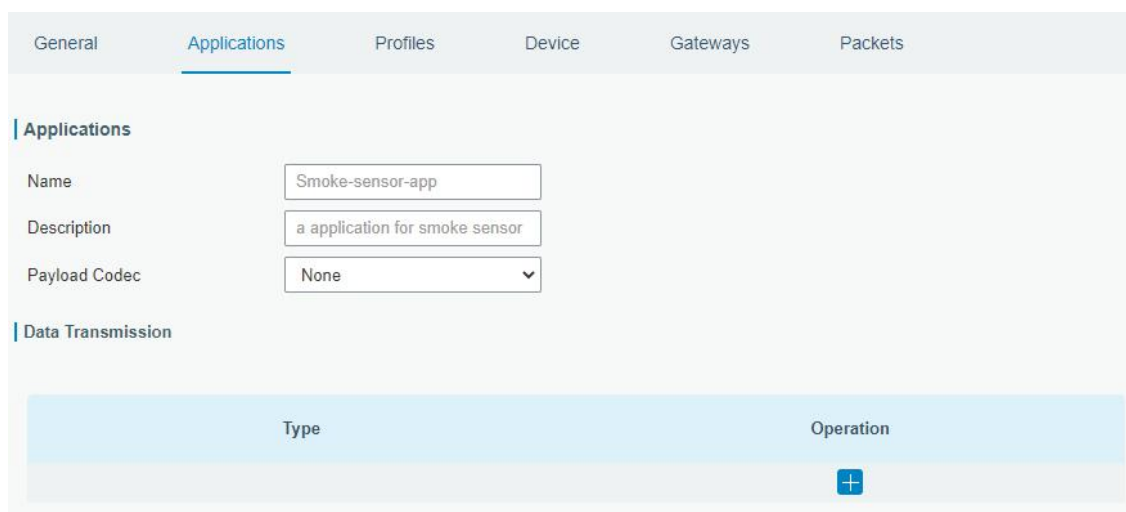

Figure 3-2-2-3

Item	Description
Name	Enter the name of the application profile. E.g Smoker-sensor-app.
Description	Enter the description of this application. E.g a application for smoker sensor.
Payload Codec	Select from: “None”, “Cayenne LPP”, “Custom”. None: This mode enables devices not to encode data. Cayenne LPP: This mode enables devices to encode data with the Cayenne Low Power Payload (LPP). Custom: This mode enables devices to encode data with the decoder function and the encoder function which you have entered the code.
Data Transmission	Data will be sent to your custom server using the MQTT,HTTP or HTTPS protocol.

Table 3-2-2-3 Application Parameters

Type MQTT

Status -

**General**

Broker Address

Broker Port

Client ID

Connection Timeout/s

Keep Alive Interval/s

**User Credentials**

Enable

Username

Password

Figure 3-2-2-4

**TLS**

Enable

Mode Self signed certificates

CA File  Browse Import Delete

Client Certificate File  Browse Import Delete

Client Key File  Browse Import Delete

**Topic**

Data Type	topic	
Uplink data	<input style="width: 100%;" type="text"/>	<span style="border: 1px solid #ccc; padding: 2px;">QoS 0</span>
Downlink data	<input style="width: 100%;" type="text"/>	<span style="border: 1px solid #ccc; padding: 2px;">QoS 0</span>
Join notification	<input style="width: 100%;" type="text"/>	<span style="border: 1px solid #ccc; padding: 2px;">QoS 0</span>
ACK notification	<input style="width: 100%;" type="text"/>	<span style="border: 1px solid #ccc; padding: 2px;">QoS 0</span>
Error notification	<input style="width: 100%;" type="text"/>	<span style="border: 1px solid #ccc; padding: 2px;">QoS 0</span>

Figure 3-2-2-5



MQTT Settings		
Item	Description	Default
<b>General</b>		
Broker Address	MQTT broker address to receive data.	--
Broker Port	MQTT broker port to receive data.	--
Client ID	Client ID is the unique identity of the client to the server. It must be unique when all clients are connected to the same server, and it is the key to handle message at QoS 1 and 2.	--
Connection Timeout/s	If the client does not get a response after the connection timeout, the connection will be considered as broken. The Range: 1-65535	30
Keep Alive Interval/s	After the client is connected with the server, the client will send heartbeat packet to the server regularly to keep alive. Range: 1-65535	60
<b>User Credentials</b>		
Enable	Enable user credentials.	
Username	The username used for connecting to MQTT broker.	
Password	The password used for connecting to MQTT broker.	
<b>TLS</b>		
Enable	Enable the TLS encryption in MQTT communication.	
Mode	Select from "Self signed certificates", "CA signed server certificate". CA signed server certificate: verify with the certificate issued by Certificate Authority (CA) that pre-loaded on device. Self signed certificates: upload the custom CA certificates, client certificates and secret key for verification.	
<b>Topic</b>		
Data Type	Data type sent to MQTT broker.	
Topic	Topic name of the data type using for publish.	
QoS	QoS 0 – Only Once This is the fastest method and requires only 1 message. It is also the most unreliable transfer mode. QoS 1 – At Least Once This level guarantees that the message will be delivered at least once, but may be delivered more than once. QoS 2 – Exactly Once QoS 2 is the highest level of service in MQTT. This level guarantees that each message is received only once by the intended recipients. QoS 2 is the safest and slowest quality of service level.	

Table 3-2-2-4 MQTT Settings Parameters

**HTTP Header**

Header Name	Header Value	Operation

**URL**

Data Type	URL
Uplink data	<input type="text"/>
Join notification	<input type="text"/>
ACK notification	<input type="text"/>
Error notification	<input type="text"/>

Figure 3-2-2-6

HTTP/HTTPS Settings	
Item	Description
HTTP Header	
Header Name	A core set of fields in HTTP header.
Header Value	Value of the HTTP header.
URL	
Data Type	Data type sent to HTTP/HTTPS server.
Topic	Topic name of the data type using for publish.
URL	HTTP/HTTPS server URL to receive data.

Table 3-2-2-5 HTTP/HTTPS Settings Parameters

### Related Configuration Example

[Application configuration](#)

#### 3.2.2.3 Profiles

A Profile defines the device capabilities and boot parameters that are needed by the Network Server for setting the LoRaWAN® radio access service. These information elements shall be provided by the end-device manufacturer.

You can edit the device profile by clicking or create a new device profile by clicking



General	Applications	Profiles	Device	Gateways	Packets
<b>Device Profiles</b>					
Name	Max TXPower	Join Type	Class Type	Operation	
ABP-calssC	0	ABP	Class C		

Figure 3-2-2-7

**Device Profiles**

Name

Max TXPower

Join Type

Class Type

Advanced

Figure 3-2-2-8

Device Profiles Settings		
Item	Description	Default
Name	Enter the name of the device profile. E.g. Smoker-sensor-app.	Null
Max TXPower	Enter the maximum transmit power. The TXPower indicates power levels relative to the Max EIRP level of the end-device. 0 means using the max EIRP. EIRP refers to the Equivalent Isotropically Radiated Power.	0
Join Type	Select from: "OTAA" and "ABP". OTAA:Over-the-Air Activation. For over-the-air activation, end-devices must follow a join procedure prior to participating in data exchanges with the network server. An end-device has to go through a new join procedure every time as it has lost the session context information.  ABP: Activation by Personalization. Under certain circumstances, end-devices can be activated by personalization. Activation by	OTAA

	personalization directly ties an end-device to a specific network bypassing the join request - join accept procedure.	
Class Type	<p>Select from: "Class A" and "Class C".</p> <p>Class A: Class A operation has the lowest power consumption for applications that require downlink communication from the server shortly after the end-device has sent an uplink transmission.</p> <p>Class C: End-device of Class C will continuously open receive windows, only closed when transmitting. Class C end-device will spend more power than Class A or Class B but they offer the lowest latency for server to end-device communication.</p>	Class A

Table 3-2-2-6 Device Profiles Setting Parameters

Advanced

MAC Version

Regional Parameters Revision

RX1 Datarate Offset

RX2 Datarate

RX2 Channel Frequency  HZ

Frequency List  Hz

ACK Timeout  sec

Figure 3-2-2-9

Device Profile Advanced Settings		
Item	Description	Default
MAC Version	Choose the version of the LoRaWAN <sup>®</sup> supported by the end-device.	1.0.2
Regional Parameter Revision	Revision of the Regional Parameters document supported by the end-device.	B
RX1 Datarate Offset	Enter the offset which used for calculate the RX1 data-rate, based on the uplink data-rate. The range is based on what is specified in the LoRaWAN <sup>®</sup> regional parameters document.	Based on what is specified in the LoRaWAN <sup>®</sup> regional parameters document
RX2 Datarate	Enter the RX2 datarate which used for the RX2 receive-window. The range is based on what is specified in the LoRaWAN <sup>®</sup> regional parameters	

	document.	
RX2 Channel Frequency	Enter the RX2 channel frequency which used for the RX2 receive-window. The range is based on what is specified in the LoRaWAN® regional parameters document.	
Frequency List	List of factory-preset frequencies. The range is based on what is specified in the LoRaWAN® regional parameters document.	Null
ACK Timeout	Enter the time for confirmed downlink transmissions. Only applicable to class C.	0

Table 3-2-2-7 Device Profiles Advanced Setting Parameters

### 3.2.2.4 Device

A device is the end-device connecting to, and communicating over the LoRaWAN® network.

Figure 3-2-2-10

Item	Description
Add	Add a device.
Bulk Import	Download template and import multiple devices.
Delete All	Delete all devices in the list.
Device Name	Show the name of the device.
Device EUI	Show the EUI of the device.
Device-Profile	Show the name of the device's device profile.
Application	Show the name of the device's application.
Last Seen	Show the time of last packet received.
Activated	Show the status of the device .  means that the device has been activated.
Operation	Edit or delete the device.

Table 3-2-2-8 Device Parameters

Device Name	<input type="text" value="lora-sensor"/>
Description	<input type="text" value="a short description of your node"/>
Device EUI	<input type="text" value="24e1641194784358"/>
Device-Profile	<input type="text" value="ClassA-OTAA"/> ▼
Application	<input type="text" value="cloud"/> ▼
Modbus RTU Data Transmission	<input type="text" value="Modbus RTU to TCP"/> ▼
Fport	<input type="text"/>
TCP Port	<input type="text"/>
Frame-counter Validation	<input type="checkbox"/>
Application Key	<input type="text"/>
Device Address	<input type="text"/>
Network Session Key	<input type="text"/>
Application Session Key	<input type="text"/>
Uplink Frame-counter	<input type="text" value="0"/>
Downlink Frame-counter	<input type="text" value="0"/>

Figure 3-2-2-11

Device Configuration		
Item	Description	Default
Device Name	Enter the name of this device.	Null
Description	Enter the description of this device.	Null
Device EUI	Enter the EUI of this device.	Null
Device-Profile	Choose the device profile.	Null
Application	Choose the application profile.	Null
Modbus RTU Data Transmission	Choose from: "Disable", "Modbus RTU to TCP", "Modbus RTU over TCP". <b>This feature is only applicable to Milesight LoRaWAN® controllers.</b> -Modbus RTU to TCP: TCP client can send Modbus TCP commands to ask for controller Modbus data. -Modbus RTU over TCP: TCP client can send Modbus RTU commands to ask for controller Modbus data.	Disable
Fport	Enter the LoRaWAN® frame port for transparent transmission between Milesight LoRaWAN® controllers and UG67. Range: 2-84, 86-223.	Null

	<b>Note: this value must be the same as the Milesight LoRaWAN® controller's Fport.</b>	
TCP Port	Enter the TCP port for data transmission between the TCP Client and UG67 (as TCP Server). Range: 1-65535.	Null
Frame-Counter Validation	If disable the frame-counter validation, it will compromise security as it enables people to perform replay-attacks.	Enabled
Application Key	Whenever an end-device joins a network via over-the-air activation, the application key is used for derive the Application Session key.	Null
Device Address	The device address identifies the end-device within the current network.	Null
Network Session Key	The network session key specific for the end-device. It is used by the end-device to calculate the MIC or part of the MIC (message integrity code) of all uplink data messages to ensure data integrity.	Null
Application Session Key	The AppSKey is an application session key specific for the end-device. It is used by both the application server and the end-device to encrypt and decrypt the payload field of application-specific data messages.	Null
Uplink Frame-counter	The number of data frames which sent uplink to the network server. It will be incremented by the end-device and received by the end-device. Users can reset the a personalized end-device manually, then the frame counters on the end-device and the frame counters on the network server for that end-device will be reset to 0.	Null
Downlink Frame-counter	The number of data frames which received by the end-device downlink from the network server. It will be incremented by the network server. Users cloud reset the a personalized end-device manually, then the frame counters on the end-device and the frame counters on the network server for that end-device will be reset to 0.	Null

Table 3-2-2-9 Device Setting Parameters

## Related Configuration Example

[Device configuration](#)

### 3.2.2.5 Gateway

Other gateways can connect to UG67 network server.

Gateway ID	Name	Status	Last Seen	Operation
24E124FFFEF12263	Local Gateway	Connected	2021-01-06 11:05:42	

Figure 3-2-2-12

Item	Description
Gateway ID	Show the gateway ID.
Name	Show the name of the gateway.
Status	Show the connection status of the gateway.
Last Seen	Show the time of last packet received.
Operation	Edit or delete the gateway.

Table 3-2-2-11 Gateway Parameters

Figure 3-2-2-13

Item	Description
Gateway ID	Enter the unique gateway ID to recognize the gateway.
Name	Enter the name of this gateway.
Location	GPS data of the gateway can be edited here. If gateway sends GPS data it will replace your customized data.

Table 3-2-2-12 Gateway Setting Parameters



### 3.2.2.6 Packets

**Send Data To Device**

Device EUI	Type	Payload	Port	Confirmed
<input type="text" value="0000000000000000"/>	ASCII ▾	<input type="text"/>	<input type="text"/>	<input type="checkbox"/>

[Send](#)

**Network Server**

[Clear](#)

Device EUI	Frequency	Datarate	SNR	RSSI	Size	Fcnt	Type	Time	Details
24e1641193199962	865402500	SF11BW125	-	-	17	0	JnAcc	2019-08-09T07:18:23+02:00	<a href="#">!</a>
24e1641193199962	865402500	SF11BW125	9.5	-34	18	0	JnReq	2019-08-09T07:18:22+02:00	<a href="#">!</a>
24e1641193199962	865402500	SF8BW125	-	-	0	2	DnUnc	2019-08-09T07:17:16+02:00	<a href="#">!</a>
24e1641193199962	865402500	SF8BW125	10.8	-42	26	3	UpCnf	2019-08-09T07:17:16+02:00	<a href="#">!</a>
24e1641193199962	865062500	SF7BW125	-	-	0	1	DnUnc	2019-08-09T07:17:01+02:00	<a href="#">!</a>
24e1641193199962	865062500	SF7BW125	8.8	-46	25	2	UpCnf	2019-08-09T07:17:01+02:00	<a href="#">!</a>
24e1641193199962	865402500	SF12BW125	-	-	0	0	DnUnc	2019-08-09T07:16:53+02:00	<a href="#">!</a>
24e1641193199962	865402500	SF12BW125	7.8	-50	3	1	UpCnf	2019-08-0	<a href="#">!</a>

Figure 3-2-2-14

Send Data To Device		
Item	Description	Default
Device EUI	Enter the EUI of the device to receive the payload.	Null
Type	Choose from: "ASCII", "hex", "base64". Choose the payload type to enter in the payload Input box.	ASCII
Payload	Enter the message to be sent to this device.	Null
Port	Enter the LoRaWAN® frame port for packet transmission between device and Network Server.	Null
Confirmed	After enabled, the end device will receive downlink packet and should answer "confirmed" to the network server.	Disabled

Table 3-2-2-13 Send Data to Device Parameters

Network Server	
Item	Description
Device EUI	Show the EUI of the device.
Frequency	Show the used frequency to transmit packets.
Datarate	Show the used datarate to transmit packets.
SNR	Show the signal-noise ratio.
RSSI	Show the received signal strength indicator.
Size	Show the size of payload.
Fcnt	Show the frame counter.
Type	Show the type of the packet:

	<p>JnAcc - Join Accept Packet</p> <p>JnReq - Join Request Packet</p> <p>UpUnc - Uplink Unconfirmed Packet</p> <p>UpCnf - Uplink Confirmed Packet - ACK response from network requested</p> <p>DnUnc - Downlink Unconfirmed Packet</p> <p>DnCnf - Downlink Confirmed Packet- ACK response from end-device requested</p>
Time	Show the time of packet was sent or received.

Table 3-2-2-14 Packet Parameters

Click  to get more details about the packet. As shown:

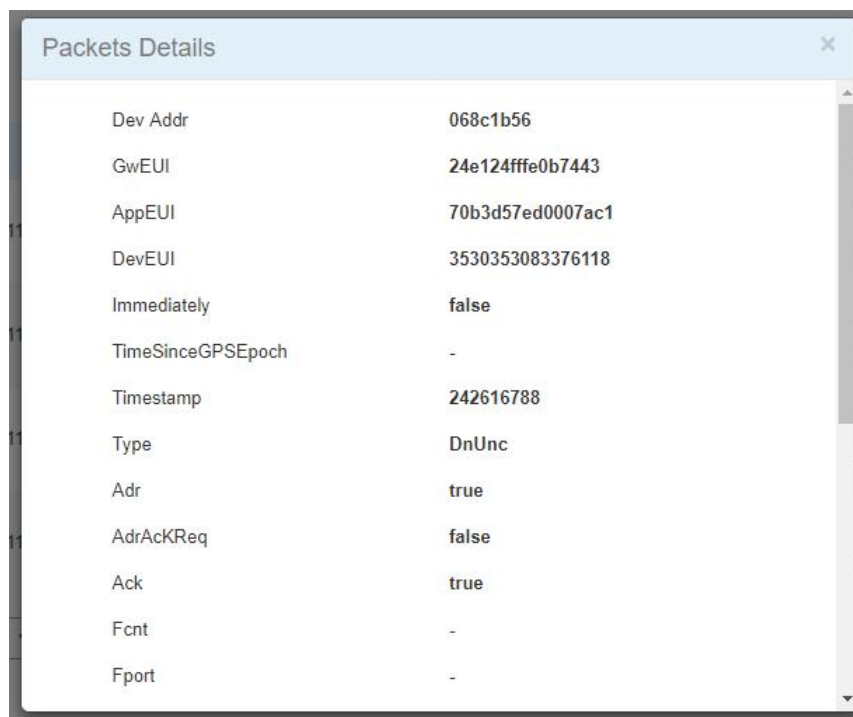

Packets Details	
Dev Addr	068c1b56
GwEUI	24e124ffe0b7443
AppEUI	70b3d57ed0007ac1
DevEUI	3530353083376118
Immediately	false
TimeSinceGPSEpoch	-
Timestamp	242616788
Type	DnUnc
Adr	true
AdrAckReq	false
Ack	true
Fcnt	-
Fport	-

Figure 3-2-2-15

Item	Description
Dev Addr	Show the address of the device.
GwEUI	Show the EUI of the gateway.
AppEUI	Show the EUI of the application.
DevEUI	Show the EUI of the device.
Immediately	True: Device may transmit an explicit (possibly empty) acknowledgement data message immediately after the reception of a data message requiring a confirmation.
TimeSinceGPSEpoch	Show the GPS time.
Timestamp	Show the timestamp of this packet.
Frequency	Show the frequency of this channel.

Type	Show the type of the packet: JnAcc - Join Accept Packet JnReq - Join Request Packet UpUnc - Uplink Unconfirmed Packet UpCnf - Uplink Confirmed Packet - ACK response from network requested DnUnc - Downlink Unconfirmed Packet DnCnf - Downlink Confirmed Packet- ACK response from end-device requested
Adr	True: The end-node has enabled ADR. False: The end-node has not enabled ADR.
AdrAckReq	In order to validate that the network is receiving the uplink messages, nodes periodically transmit ADRACKReq message. This is 1 bit long. True: Network should respond in ADR_ACK_DELAY time to confirm that it is receiving the uplink messages. False: ADR is disabled or Network does not respond in ADR_ACK_DELAY.
Ack	True: This frame is ACK. False: This frame is not ACK.
Fcnt	Show the frame-counter of this packet. The network server tracks the uplink frame counter and generates the downlink counter for each end-device.
FPort	FPort is a multiplexing port field. If the frame payload field is not empty, the port field must be present. If present, a FPort 16 value of 0 indicates that the FRMPayload contains MAC commands only. When this is the case, the FOptsLen field must be zero. FOptsLen is the length of the FOpts field in bytes.
Modulation	LoRa means the physical layer uses the LoRa modulation
Bandwidth	Show the bandwidth of this channel.
SpreadFactor	Show the spreadFactor of this channel.
Bitrate	Show the bitrate of this channel.
CodeRate	Show the coderate of this channel.
SNR	Show the SNR of this channel.
RSSI	Show the RSSI of this channel.
Power	Show the transmit power of the device.
Payload (b64)	Show the application payload of this packet.
Payload (hex)	Show the application payload of this packet.
MIC	Show the MIC of this packet. MIC is a cryptographic message integrity code, computed over the fields MHDR, FHDR, FPort and the encrypted FRMPayload.

Table 3-2-2-15 Packets Details Parameters

### Related Topic

[Send Data to Device](#)

## 3.3 Network

### 3.3.1 Interface

#### 3.3.1.1 Port

The Ethernet port can be connected with Ethernet cable to get Internet access. It supports 3 connection types.

- **Static IP:** configure IP address, netmask and gateway for Ethernet WAN interface.
- **DHCP Client:** configure Ethernet WAN interface as DHCP Client to obtain IP address automatically.
- **PPPoE:** configure Ethernet WAN interface as PPPoE Client.

Figure 3-3-1-1

Port Setting		
Item	Description	Default
Enable	Enable WAN function.	Enable
Port	The port that is currently set as eth0 port.	eth 0
Connection Type	Select from "Static IP", "DHCP Client" and "PPPoE".	Static IP
MTU	Set the maximum transmission unit.	1500
Primary DNS Server	Set the primary DNS.	Null
Secondary DNS Server	Set the secondary DNS.	Null
Enable NAT	Enable or disable NAT function. When enabled, a private IP can be translated to a public IP.	Enable

Table 3-3-1-1 Port Parameters

## 1. Static IP Configuration

If the external network assigns a fixed IP for the Ethernet port, user can select “Static IP” mode.

Port\_1

Enable

Port

Connection Type

IP Address

Netmask

Gateway

MTU

Primary DNS Server

Secondary DNS Server

Enable NAT

Multiple IP Address

IP Address	Netmask	Operation
		<input type="button" value="+"/>

Figure 3-3-1-2

Static IP		
Item	Description	Default
IP Address	Set the IP address which can access Internet.	192.168.23.150
Netmask	Set the Netmask for Ethernet port.	255.255.255.0
Gateway	Set the gateway's IP address for Ethernet port.	192.168.23.1
Multiple IP Address	Set the multiple IP addresses for Ethernet port.	Null

Table 3-3-1-2 Static IP Parameters

## 2. DHCP Client

If the external network has DHCP server enabled and has assigned IP addresses to the Ethernet WAN interface, user can select “DHCP client” mode to obtain IP address automatically.

— Port\_1

Enable	<input checked="" type="checkbox"/>
Port	<input type="text" value="eth 0"/>
Connection Type	<input style="border-bottom: 1px solid #ccc;" type="text" value="DHCP Client"/>
MTU	<input type="text" value="1500"/>
Use Peer DNS	<input type="checkbox"/>
Primary DNS Server	<input type="text" value="8.8.8.8"/>
Secondary DNS Server	<input type="text" value="114.114.114.114"/>
Enable NAT	<input checked="" type="checkbox"/>

Figure 3-3-1-3

DHCP Client	
Item	Description
Use Peer DNS	Obtain peer DNS automatically during PPP dialing. DNS is necessary when user visits domain name.

Table 3-3-1-3 DHCP Client Parameters

### 3. PPPoE

PPPoE refers to a point to point protocol over Ethernet. User has to install a PPPoE client on the basis of original connection way. With PPPoE, remote access devices can get control of each user.

— Port\_1

Enable	<input checked="" type="checkbox"/>
Port	<input type="text" value="eth 0"/>
Connection Type	<input style="border-bottom: 1px solid #ccc;" type="text" value="PPPoE"/>
Username	<input type="text"/>
Password	<input type="text"/>
Link Detection Interval(s)	<input type="text" value="60"/>
Max Retries	<input type="text" value="0"/>
MTU	<input type="text" value="1500"/>
Use Peer DNS	<input type="checkbox"/>
Primary DNS Server	<input type="text" value="8.8.8.8"/>
Secondary DNS Server	<input type="text" value="114.114.114.114"/>
Enable NAT	<input checked="" type="checkbox"/>

Figure 3-3-1-4

PPPoE	
Item	Description
Username	Enter the username provided by your Internet Service Provider (ISP).
Password	Enter the password provided by your Internet Service Provider (ISP).
Link Detection Interval (s)	Set the heartbeat interval for link detection. Range: 1-600.
Max Retries	Set the maximum retry times after it fails to dial up. Range: 0-9.
Use Peer DNS	Obtain peer DNS automatically during PPP dialing. DNS is necessary when user visits domain name.

Table 3-3-1-4 PPOE Parameters

### 3.3.1.2 WLAN

This section explains how to set the related parameters for Wi-Fi network. UG67 supports 802.11 b/g/n, as AP or client mode.

Port	WLAN	Cellular	Loopback
<b>WLAN</b>			
Enable	<input checked="" type="checkbox"/>		
Work Mode	AP		
SSID Broadcast	<input checked="" type="checkbox"/>		
AP Isolation	<input type="checkbox"/>		
Radio Type	802.11n(2.4GHz)		
Channel	Auto		
SSID			
BSSID			
Encryption Mode	WPA-PSK/WPA2-PSK		
Cipher	AES		
Key	.....		
Bandwidth	20MHz		
Max Client Number	128		
<b>IP Setting</b>			
Protocol	Static IP		
IP Address			
Netmask	255.255.255.0		

Figure 3-3-1-5

**WLAN**

Enable

Work Mode Client Scan

SSID

BSSID

Encryption Mode WPA-PSK/WPA2-PSK

Cipher Auto

Key

---

**IP Setting**

Protocol Static IP

IP Address

Netmask 255.255.255.0

Gateway

Figure 3-3-1-6

WLAN Settings	
Item	Description
Enable	Enable/disable WLAN.
Work Mode	Select gateway's work mode. The options are "Client" or "AP".
BSSID	Fill in the MAC address of the access point. Either SSID or BSSID can be filled to joint the network.
SSID	Fill in the SSID of the access point.
Client Mode	
Scan	Click "Scan" button to search the nearby access point.
Encryption Mode	Select encryption mode. The options are "No Encryption", "WEP Open System", "WEP Shared Key", "WPA-PSK", "WPA2-PSK", "WPA-PSK/WPA2-PSK", "WPA-Enterprise", "WPA2-Enterprise" and "WPA-Enterprise/WPA2-Enterprise".
Cipher	Select cipher. The options are "Auto", "AES", "TKIP" and "AES/TKIP".
Key	Fill the pre-shared key of WEP/WPA encryption.
XSupplicant Type	Select from "Peap", "Leap", "TLS" and "TTLS".
User	Fill the user of WPA/WPA2-Enterprise.
Anonymous Identity	Fill the anonymous identity of WPA/WPA2-Enterprise.
Phase2	Fill the phase2 of WPA/WPA2-Enterprise.
Public Server Certificate	The public server certificate used for verifying with WPA/WPA2-Enterprise access point.
AP Mode	
SSID Broadcast	When SSID broadcast is disabled, other wireless devices can't not find the SSID, and users have to enter the SSID manually to



	access to the wireless network.
AP Isolation	When AP isolation is enabled, all users which access to the AP are isolated without communication with each other.
Radio Type	Select Radio type. The options are "802.11b (2.4 GHz)", "802.11g (2.4 GHz)", "802.11n (2.4 GHz)".
Channel	Select wireless channel. The options are "Auto", "1", "2"....."11".
Encryption Mode	Select encryption mode. The options are "No Encryption", "WEP Open System", "WEP Shared Key", "WPA-PSK", "WPA2-PSK" and "WPA-PSK/WPA2-PSK".
Cipher	Select cipher. The options are "Auto", "AES", "TKIP" and "AES/TKIP".
Key	Fill the pre-shared key of WPA encryption.
Bandwidth	Select bandwidth. The options are "20MHz" and "40MHz".
Max Client Number	Set the maximum number of client to access when the gateway is configured as AP.
<b>IP Setting</b>	
Protocol	Set the protocol in wireless network.
IP Address	Set the IP address in wireless network.
Netmask	Set the netmask in wireless network.
Gateway	Set the gateway in wireless network.

Table 3-3-1-5 WLAN Parameters

Port	WLAN	Cellular	Loopback				
<a href="#">&lt; GoBack</a>							
SSID	Channel	Signal	Cipher	BSSID	Security	Frequency	
Ursalink_F0C425	Auto	-74dBm	Auto	24:e1:24:f0:c4:25	No Encryption	2412MHz	<a href="#">Join Network</a>
Yeastar-VPN	Auto	-76dBm	Auto	48:7a:da:40:83:d1	No Encryption	2462MHz	<a href="#">Join Network</a>
Yeastar-VPN	Auto	-70dBm	Auto	48:7a:da:40:76:91	No Encryption	2412MHz	<a href="#">Join Network</a>
Ursalink_F0D908	Auto	-72dBm	Auto	24:e1:24:f0:d9:08	No Encryption	2462MHz	<a href="#">Join Network</a>
Ursalink_F0C419	Auto	-66dBm	Auto	24:e1:24:f0:c4:19	No Encryption	2412MHz	<a href="#">Join Network</a>
Yeastar-VPN	Auto	-84dBm	Auto	48:7a:da:40:7c:d1	No Encryption	2437MHz	<a href="#">Join Network</a>
Ursalink_F02F77	Auto	-58dBm	Auto	24:e1:24:f0:2f:77	No Encryption	2447MHz	<a href="#">Join Network</a>

Figure 3-3-1-7

<b>Client Mode-Scan</b>	
SSID	Show SSID.
Channel	Show wireless channel.
Signal	Show wireless signal.
BSSID	Show the MAC address of the access point.

Security	Show the encryption mode.
Frequency	Show the frequency of radio.
Join Network	Click the button to join the wireless network.

Table 3-3-1-6 WLAN Scan Parameters

## Related Topic

[Wi-Fi Application Example](#)

### 3.3.1.3 Cellular

This section explains how to set the related parameters for cellular network.

Port	WLAN	Cellular	Loopback
<b>Cellular Setting</b>			
Enable		<input checked="" type="checkbox"/>	
Network Type		Auto	
APN			
Username			
Password			
Access Number			
PIN Code			
Authentication Type		Auto	
Roaming		<input checked="" type="checkbox"/>	
SMS Center			

Figure 3-3-1-8

Connection Setting	<input type="checkbox"/>
Enable NAT	<input checked="" type="checkbox"/>
Restart When Dial-up failed	<input type="checkbox"/>
ICMP Server	<input type="text" value="8.8.8.8"/>
Secondary ICMP Server	<input type="text" value="114.114.114.114"/>
ICMP Detection Max Retries	<input type="text" value="3"/>
ICMP Detection Timeout	<input type="text" value="5"/> s
ICMP Detection Interval	<input type="text" value="15"/> s
<b>SMS Settings</b>	
SMS Mode	<input type="text" value="PDU"/>

Figure 3-3-1-9

General Settings		
Item	Description	Default
Enable	Check the option to enable the corresponding SIM card.	Enable
Network Type	Select from "Auto", "Auto 3G/4G", "4G Only" and "3G Only". Auto: connect to the network with the strongest signal automatically. 4G Only: connect to 4G network only. And so on.	Auto
APN	Enter the Access Point Name for cellular dial-up connection provided by local ISP.	Null
Username	Enter the username for cellular dial-up connection provided by local ISP.	Null
Password	Enter the password for cellular dial-up connection provided by local ISP.	Null
Access Number	Enter the dial-up center NO. For cellular dial-up connection provided by local ISP.	Null
PIN Code	Enter a 4-8 characters PIN code to unlock the SIM.	Null
Authentication Type	Select from "Auto", "PAP", "CHAP", "MS-CHAP", and "MS-CHAPv2".	Auto
Roaming	Enable or disable roaming.	Disable
SMS Center	Enter the local SMS center number for storing, forwarding, converting and delivering SMS message.	Null
Enable NAT	Enable or disable NAT function.	Enable
Restart When	When this function is enabled, the gateway will restart	Disabled

Dial-up failed	automatically if the dial-up fails several times.	
ICMP Server	Set the ICMP detection server's IP address.	8.8.8.8
Secondary ICMP Server	Set the secondary ICMP detection server's IP address.	114.114.114.114
ICMP Detection Max Retries	Set max number of retries when ICMP detection fails.	3
ICMP Detection Timeout	Set timeout of ICMP detection.	5
ICMP Detection Interval	Set interval of ICMP detection.	15
SMS Mode	Select SMS mode from "TEXT" and "PDU".	PDU

Table 3-3-1-7 Cellular Parameters

Figure 3-3-1-10

Item	Description
<b>Connection Mode</b>	
Connection Mode	Select from "Always Online" and "Connect on Demand".
Redial Interval(s)	Set the time interval between redials. Range: 0-3600.
Max Idle Time(s)	Set the maximum duration of the gateway when current link is under idle status. Range: 10-3600.
Triggered by Call	The gateway will switch from offline mode to cellular network mode automatically when it receives a call from the specific phone number.
Call Group	Select a call group for call trigger. Go to "System > General Settings > Phone" to set up phone group.
Triggered by SMS	The gateway will switch from offline mode to cellular network mode automatically when it receives a specific SMS from the specific mobile phone.
SMS Group	Select a SMS group for trigger. Go to "System > General Settings > Phone" to set up SMS group.
SMS Text	Fill in the SMS content for triggering.

Table 3-3-1-8 Cellular Parameters

### Related Topics

[Cellular Connection Application Example](#)

## Phone Group

### 3.3.1.4 Loopback

Loopback interface is used for replacing gateway's ID as long as it is activated. When the interface is DOWN, the ID of the gateway has to be selected again which leads to long convergence time of OSPF. Therefore, Loopback interface is generally recommended as the ID of the gateway.

Loopback interface is a logic and virtual interface on gateway. Under default conditions, there's no loopback interface on gateway, but it can be created as required.

Figure 3-3-1-11

Loopback		
Item	Description	Default
IP Address	Unalterable	127.0.0.1
Netmask	Unalterable	255.0.0.0
Multiple IP Addresses	Apart from the IP above, user can configure other IP addresses.	Null

Table 3-3-1-9 Loopback Parameters

### 3.3.2 Firewall

This section describes how to set the firewall parameters, including website block, ACL, DMZ, Port Mapping and MAC Binding.

The firewall implements corresponding control of data flow at entry direction (from Internet to local area network) and exit direction (from local area network to Internet) according to the content features of packets, such as protocol style, source/destination IP address, etc. It ensures that the gateway operate in a safe environment and host in local area network.

### 3.3.2.1 Security

The screenshot shows the 'Security' configuration page. At the top, there are navigation tabs: 'Security' (selected), 'ACL', 'DMZ', 'Port Mapping', and 'MAC Binding'. Below the tabs, there are two main sections for website blocking:

- Website Blocking by URL Address:** A text input field contains 'http://'. To the right of the field are two small blue buttons: one with an 'X' (delete) and one with a '+' (add).
- Website Blocking by Keyword:** An empty text input field. To the right of the field are two small blue buttons: one with an 'X' (delete) and one with a '+' (add).

At the bottom left of the configuration area, there is a blue 'Save' button.

Figure 3-3-2-1

Website Blocking	
URL Address	Enter the HTTP address which you want to block.
Keyword	You can block specific website by entering keyword. The maximum number of character allowed is 64.

Table 3-2-2-1 Security Parameters

### 3.3.2.2 ACL

Access control list, also called ACL, implements permission or prohibition of access for specified network traffic (such as the source IP address) by configuring a series of matching rules so as to filter the network interface traffic. When gateway receives packet, the field will be analyzed according to the ACL rule applied to the current interface. After the special packet is identified, the permission or prohibition of corresponding packet will be implemented according to preset strategy.

The data package matching rules defined by ACL can also be used by other functions requiring flow distinction.

Security
**ACL**
DMZ
Port Mapping
MAC Binding

**ACL Setting**

Default Filter Policy Accept ▼

**Access Control List**

Type	extended <span style="font-size: 0.8em;">▼</span>
ID	
Action	permit <span style="font-size: 0.8em;">▼</span>
Protocol	ip <span style="font-size: 0.8em;">▼</span>
Source IP	
Source Wildcard Mask	0.0.0.0
Destination IP	
Destination Wildcard Mask	0.0.0.0
Description	

Save
Cancel

**Interface List**

Interface	In ACL	Out ACL	Operation
			<span style="border: 1px solid #007bff; padding: 2px 5px; font-size: 0.8em;">+</span>

Figure 3-3-2-2

Item	Description
<b>ACL Setting</b>	
Default Filter Policy	Select from "Accept" and "Deny". The packets which are not included in the access control list will be processed by the default filter policy.
<b>Access Control List</b>	
Type	Select type from "Extended" and "Standard".
ID	User-defined ACL number. Range: 1-199.
Action	Select from "Permit" and "Deny".
Protocol	Select protocol from "ip", "icmp", "tcp", "udp", and "1-255".
Source IP	Source network address (leaving it blank means all).
Source Wildcard Mask	Wildcard mask of the source network address.
Destination IP	Destination network address (0.0.0.0 means all).
Destination Wildcard Mask	Wildcard mask of destination address.
Description	Fill in a description for the groups with the same ID.
ICMP Type	Enter the type of ICMP packet. Range: 0-255.
ICMP Code	Enter the code of ICMP packet. Range: 0-255.
Source Port Type	Select source port type, such as specified port, port range, etc.
Source Port	Set source port number. Range: 1-65535.
Start Source Port	Set start source port number. Range: 1-65535.
End Source Port	Set end source port number. Range: 1-65535.

Destination Port Type	Select destination port type, such as specified port, port range, etc.
Destination Port	Set destination port number. Range: 1-65535.
Start Destination Port	Set start destination port number. Range: 1-65535.
End Destination Port	Set end destination port number. Range: 1-65535.
More Details	Show information of the port.
<b>Interface List</b>	
Interface	Select network interface for access control.
In ACL	Select a rule for incoming traffic from ACL ID.
Out ACL	Select a rule for outgoing traffic from ACL ID.

Table 3-3-2-2 ACL Parameters

### 3.3.2.3 DMZ

DMZ is a host within the internal network that has all ports exposed, except those forwarded ports in port mapping.

Figure 3-3-2-3

DMZ	
Item	Description
Enable	Enable or disable DMZ.
DMZ Host	Enter the IP address of the DMZ host on the internal network.
Source Address	Set the source IP address which can access to DMZ host. "0.0.0.0/0" means any address.

Table 3-3-2-3 DMZ Parameters

### 3.3.2.4 Port Mapping

Port mapping is an application of network address translation (NAT) that redirects a communication request from the combination of an address and port number to another while the packets are traversing a network gateway such as a gateway or firewall.

Click to add a new port mapping rules.



Figure 3-3-2-4

Port Mapping	
Item	Description
Source IP	Specify the host or network which can access local IP address. 0.0.0.0/0 means all.
Source Port	Enter the TCP or UDP port from which incoming packets are forwarded. Range: 1-65535.
Destination IP	Enter the IP address that packets are forwarded to after being received on the incoming interface.
Destination Port	Enter the TCP or UDP port that packets are forwarded to after being received on the incoming port(s). Range: 1-65535.
Protocol	Select from "TCP" and "UDP" as your application required.
Description	The description of this rule.

Table 3-3-2-4 Port Mapping Parameters

## Related Configuration Example

[NAT Application Example](#)

### 3.3.2.5 MAC Binding

MAC Binding is used for specifying hosts by matching MAC addresses and IP addresses that are in the list of allowed outer network access.

Figure 3-3-2-5

MAC Binding List	
Item	Description
MAC Address	Set the binding MAC address.

IP Address	Set the binding IP address.
Description	Fill in a description for convenience of recording the meaning of the binding rule for each piece of MAC-IP.

Table 3-3-2-5 MAC Binding Parameters

### 3.3.3 DHCP

UG67 can be set as a DHCP server to distribute IP address when Wi-Fi work as AP mode.

Figure 3-3-3-1

DHCP Server		
Item	Description	Default
Enable	Enable or disable DHCP server.	Enable
Interface	Only wlan interface is allowed to distribute IP addresses.	wlan0
Start Address	Define the beginning of the pool of IP addresses which will be leased to DHCP clients.	192.168.1.100
End Address	Define the end of the pool of IP addresses which will be leased to DHCP clients.	192.168.1.199
Netmask	Define the subnet mask of IP address obtained by DHCP clients from DHCP server.	255.255.255.0
Lease Time (Min)	Set the lease time on which the client can use the IP address obtained from DHCP server. Range: 1-10080.	1440
Primary	Set the primary DNS server.	114.114.114.114

DNS Server		
Secondary DNS Server	Set the secondary DNS server.	Null
Windows Name Server	Define the Windows Internet Naming Service obtained by DHCP clients from DHCP sever. Generally you can leave it blank.	Null
<b>Static IP</b>		
MAC Address	Set a static and specific MAC address for the DHCP client (it should be different from other MACs so as to avoid conflict).	Null
IP Address	Set a static and specific IP address for the DHCP client (it should be outside of the DHCP range).	Null

Table 3-3-3-1 DHCP Server Parameters

### 3.3.4 DDNS

Dynamic DNS (DDNS) is a method that automatically updates a name server in the Domain Name System, which allows user to alias a dynamic IP address to a static domain name. DDNS serves as a client tool and needs to coordinate with DDNS server. Before starting configuration, user shall register on a website of proper domain name provider and apply for a domain name.

The screenshot shows a web-based configuration page for DDNS. At the top, there is a 'DDNS' header. Below it, a section titled 'DDNS Method List' contains a table with the following columns: Name, Interface, Service Type, Username, User ID, Password, Server, Server Path, Hostname, Append IP, and Operation. The 'Interface' column is set to 'wlan0' and the 'Service Type' column is set to 'DynDI'. There are input fields for 'Username', 'User ID', and 'Password', and a checkbox for 'Append IP'. A blue 'X' icon is visible in the 'Operation' column, and a blue '+' icon is at the bottom right.

Figure 3-3-4-1

DDNS	
Item	Description
Name	Give the DDNS a descriptive name.
Interface	Set interface bundled with the DDNS.
Service Type	Select the DDNS service provider.
Username	Enter the username for DDNS register.
User ID	Enter User ID of the custom DDNS server.
Password	Enter the password for DDNS register.
Server	Enter the name of DDNS server.
Hostname	Enter the hostname for DDNS.
Append IP	Append your current IP to the DDNS server update path.

Table 3-3-4-1 DDNS Parameters

### 3.3.5 Link Failover

This section describes how to configure link failover strategies, such as VRRP strategies.

#### Configuration Steps

1. Define one or more SLA operations (ICMP probe).
2. Define one or more track objects to track the status of SLA operation.
3. Define applications associated with track objects, such as VRRP or static routing.

#### 3.3.5.1 SLA

SLA setting is used for configuring link probe method. The default probe type is ICMP.

Figure 3-3-5-1

SLA		
Item	Description	Default
ID	SLA index. Up to 10 SLA settings can be added. Range: 1-10.	1
Type	ICMP-ECHO is the default type to detect if the link is alive.	icmp-echo
Destination Address	The detected IP address.	114.114.114.114
Secondary Destination Address	The secondary detected IP address.	8.8.8.8
Data Size	User-defined data size. Range: 0-1000.	56
Interval (s)	User-defined detection interval. Range: 1-608400.	30
Timeout (ms)	User-defined timeout for response to determine ICMP detection failure. Range: 1-300000.	5000
Packet Loss Count	Define packet loss count in each SLA probe. SLA probe fails when the preset packet loss count is exceeded.	5
Start Time	Detection start time; select from "Now" and blank character. Blank character means this SLA detection doesn't start.	now

Table 3-3-5-1 SLA Parameters

### 3.3.5.2 Track

Track setting is designed for achieving linkage among SLA module, Track module and Application module. Track setting is located between application module and SLA module with main function of shielding the differences of various SLA modules and providing unified interfaces for application module.

#### Linkage between Track Module and SLA module

Once you complete the configuration, the linkage relationship between Track module and SLA module will be established. SLA module is used for detection of link status, network performance and notification of Track module. The detection results help track status change timely.

- For successful detection, the corresponding track item is Positive.
- For failed detection, the corresponding track item is Negative.

#### Linkage between Track Module and Application Module

After configuration, the linkage relationship between Track module and Application module will be established. When any change occurs in track item, a notification that requires corresponding treatment will be sent to Application module.

Currently, the application modules like VRRP and static routing can get linkage with track module.

If it sends an instant notification to Application module, the communication may be interrupted in some circumstances due to routing's failure like timely restoration or other reasons. Therefore, user can set up a period of time to delay notifying application module when the track item status changes.

ID	Type	SLA ID	Interface	Negative Delay(s)	Positive Delay(s)	Operation
1	sla	1	wlan0	0	1	[X] [ + ]

Figure 3-3-5-2

Item	Description	Default
Index	Track index. Up to 10 track settings can be configured. Range: 1-10.	1
Type	The options are "sla" and "interface".	SLA
SLA ID	Defined SLA ID.	1
Interface	Select the interface whose status will be detected.	cellular0
Negative Delay (s)	When interface is down or SLA probing fails, it will wait according to the time set here before actually changing its status to Down. Range: 0-180 (0 refers to immediate switching).	0

Positive Delay (s)	When failure recovery occurs, it will wait according to the time set here before actually changing its status to Up. Range: 0-180 (0 refers to immediate switching).	1
--------------------	----------------------------------------------------------------------------------------------------------------------------------------------------------------------	---

Table 3-3-5-2 Track Parameters

### 3.3.5.3 WAN Failover

WAN failover refers to failover between Ethernet WAN interface and cellular interface. When service transmission can't be carried out normally due to malfunction of a certain interface or lack of bandwidth, the rate of flow can be switched to backup interface quickly. Then the backup interface will carry out service transmission and share network flow so as to improve reliability of communication of data equipment.

When link state of main interface is switched from up to down, system will have the pre-set delay works instead of switching to link of backup interface immediately. Only if the state of main interface is still down after delay, will the system switch to link of backup interface. Otherwise, system will remain unchanged.

Main Interface	Backup Interface	Startup Delay(s)	Up Delay(s)	Down Delay(s)	Track ID	Operation
Cellular 0	eth 0	30	0	0	1	X
+						

Figure 3-3-5-3

WAN Failover		
Parameters	Description	Default
Main Interface	Select a link interface as the main link.	--
Backup Interface	Select a link interface as the backup link.	--
Startup Delay (s)	Set how long to wait for the startup tracking detection policy to take effect. Range: 0-300.	30
Up Delay (s)	When the primary interface switches from failed detection to successful detection, switching can be delayed based on the set time. Range: 0-180 (0 refers to immediate switching)	0
Down Delay (s)	When the primary interface switches from successful detection to failed detection, switching can be delayed based on the set time. Range: 0-180 (0 refers to immediate switching).	0
Track ID	Track detection, select the defined track ID.	--

Table 3-3-5-3 WAN Failover Parameters

### 3.3.6 VPN

Virtual Private Networks, also called VPNs, are used to securely connect two private networks together so that devices can connect from one network to the other network via secure channels.

UG67 supports DMVPN, IPsec, GRE, L2TP, PPTP, OpenVPN, as well as GRE over IPsec and L2TP over IPsec.

#### 3.3.6.1 DMVPN

A dynamic multi-point virtual private network (DMVPN), combining mGRE and IPsec, is a secure network that exchanges data between sites without passing traffic through an organization's headquarter VPN server or gateway.

Figure 3-3-6-1

Figure 3-3-6-2

DMVPN	
Item	Description
Enable	Enable or disable DMVPN.
Hub Address	The IP address or domain name of DMVPN Hub.
Local IP address	DMVPN local tunnel IP address.

GRE Hub IP Address	GRE Hub tunnel IP address.
GRE Local IP Address	GRE local tunnel IP address.
GRE Netmask	GRE local tunnel netmask.
GRE Key	GRE tunnel key.
Negotiation Mode	Select from "Main" and "Aggressive".
Authentication Algorithm	Select from "DES", "3DES", "AES128", "AES192" and "AES256".
Encryption Algorithm	Select from "MD5" and "SHA1".
DH Group	Select from "MODP768_1", "MODP1024_2" and "MODP1536_5".
Key	Enter the preshared key.
Local ID Type	Select from "Default", "ID", "FQDN", and "User FQDN"
IKE Life Time (s)	Set the lifetime in IKE negotiation. Range: 60-86400.
SA Algorithm	Select from "DES_MD5", "DES_SHA1", "3DES_MD5", "3DES_SHA1", "AES128_MD5", "AES128_SHA1", "AES192_MD5", "AES192_SHA1", "AES256_MD5" and "AES256_SHA1".
PFS Group	Select from "NULL", "MODP768_1", "MODP1024_2" and "MODP1536-5".
Life Time (s)	Set the lifetime of IPsec SA. Range: 60-86400.
DPD Interval Time (s)	Set DPD interval time
DPD Timeout (s)	Set DPD timeout.
Cisco Secret	Cisco Nhrp key.
NHRP Holdtime (s)	The holdtime of Nhrp protocol.

Table 3-3-6-1 DMVPN Parameters

### 3.3.6.2 IPsec

IPsec is especially useful for implementing virtual private networks and for remote user access through dial-up connection to private networks. A big advantage of IPsec is that security arrangements can be handled without requiring changes to individual user computers.

IPsec provides three choices of security service: Authentication Header (AH), Encapsulating Security Payload (ESP), and Internet Key Exchange (IKE). AH essentially allows authentication of the senders' data. ESP supports both authentication of the sender and data encryption. IKE is used for cipher code exchange. All of them can protect one and more data flows between hosts, between host and gateway, and between gateways.



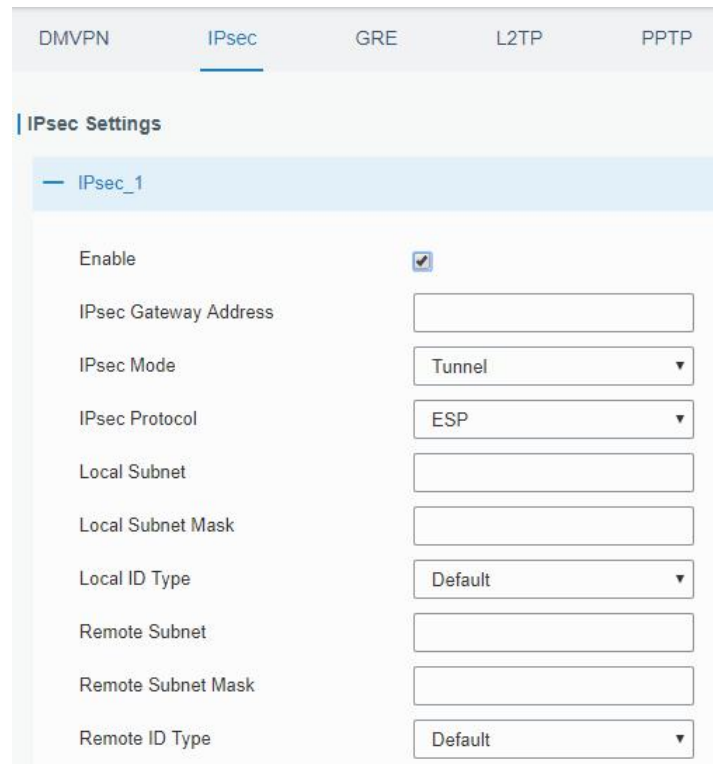

DMVPN IPsec GRE L2TP PPTP

**IPsec Settings**

— IPsec\_1

Enable

IPsec Gateway Address

IPsec Mode

IPsec Protocol

Local Subnet

Local Subnet Mask

Local ID Type

Remote Subnet

Remote Subnet Mask

Remote ID Type

Figure 3-3-6-3

IPsec	
Item	Description
Enable	Enable IPsec tunnel. A maximum of 3 tunnels is allowed.
IPsec Gateway Address	Enter the IP address or domain name of remote IPsec server.
IPsec Mode	Select from "Tunnel" and "Transport".
IPsec Protocol	Select from "ESP" and "AH".
Local Subnet	Enter the local subnet IP address that IPsec protects.
Local Subnet Netmask	Enter the local netmask that IPsec protects.
Local ID Type	Select from "Default", "ID", "FQDN", and "User FQDN".
Remote Subnet	Enter the remote subnet IP address that IPsec protects.
Remote Subnet Mask	Enter the remote netmask that IPsec protects.
Remote ID type	Select from "Default", "ID", "FQDN", and "User FQDN".

Table 3-3-6-2 IPsec Parameters

IKE Parameter	<input checked="" type="checkbox"/>
IKE Version	IKEv1
Negotiation Mode	Main
Encryption Algorithm	DES
Authentication Algorithm	MD5
DH Group	MODP768-1
Local Authentication	PSK
Local Secrets	
XAUTH	<input type="checkbox"/>
Lifetime(s)	10800
SA Parameter	<input checked="" type="checkbox"/>
SA Algorithm	DES-MD5
PFS Group	NULL
Lifetime(s)	3600
DPD Time Interval(s)	30
DPD Timeout(s)	150
IPsec Advanced	<input checked="" type="checkbox"/>
Enable Compression	<input type="checkbox"/>
VPN Over IPsec Type	NONE

Figure 3-3-6-4

IKE Parameter	
Item	Description
IKE Version	Select from "IKEv1" and "IKEv2".
Negotiation Mode	Select from "Main" and "Aggressive".
Encryption Algorithm	Select from "DES", "3DES", "AES128", "AES192" and "AES256".
Authentication Algorithm	Select from "MD5" and "SHA1"
DH Group	Select from "MODP768_1", "MODP1024_2" and "MODP1536_5".
Local Authentication	Select from "PSK" and "CA".
Local Secrets	Enter the preshared key.
XAUTH	Enter XAUTH username and password after XAUTH is enabled.
Lifetime (s)	Set the lifetime in IKE negotiation. Range: 60-86400.
SA Parameter	
SA Algorithm	Select from "DES_MD5", "DES_SHA1", "3DES_MD5", "3DES_SHA1", "AES128_MD5", "AES128_SHA1", "AES192_MD5", "AES192_SHA1", "AES256_MD5" and "AES256_SHA1".
PFS Group	Select from "NULL", "MODP768_1", "MODP1024_2" and "MODP1536_5".
Lifetime (s)	Set the lifetime of IPsec SA. Range: 60-86400.

DPD Interval Time(s)	Set DPD interval time to detect if the remote side fails.
DPD Timeout(s)	Set DPD timeout. Range: 10-3600.
<b>IPsec Advanced</b>	
Enable Compression	The head of IP packet will be compressed after it's enabled.
VPN Over IPsec Type	Select from "NONE", "GRE" and "L2TP" to enable VPN over IPsec function.

Table 3-3-6-3 IPsec Parameters

### 3.3.6.3 GRE

Generic Routing Encapsulation (GRE) is a protocol that encapsulates packets in order to route other protocols over IP networks. It's a tunneling technology that provides a channel through which encapsulated data message can be transmitted and encapsulation and decapsulation can be realized at both ends.

In the following circumstances the GRE tunnel transmission can be applied:

- GRE tunnel can transmit multicast data packets as if it were a true network interface. Single use of IPsec cannot achieve the encryption of multicast.
- A certain protocol adopted cannot be routed.
- A network of different IP addresses shall be required to connect other two similar networks.

The screenshot displays the 'GRE Settings' configuration page. At the top, there are tabs for 'DMVPN', 'IPsec', 'GRE' (selected), 'L2TP', and 'PPTP'. Below the tabs, the 'GRE Settings' section is visible, with a sub-section for 'GRE\_1'. The configuration includes the following items:

- Enable:** A checked checkbox.
- Remote IP Address:** An empty text input field.
- Local IP Address:** An empty text input field.
- Local Virtual IP Address:** An empty text input field.
- Netmask:** A text input field containing '255.255.255.0'.
- Peer Virtual IP Address:** An empty text input field.
- Global Traffic Forwarding:** An unchecked checkbox.
- Remote Subnet:** An empty text input field.
- Remote Netmask:** An empty text input field.
- MTU:** A text input field containing '1500'.
- Key:** An empty text input field.
- Enable NAT:** A checked checkbox.

Figure 3-3-6-5

GRE	
Item	Description
Enable	Check to enable GRE function.

Remote IP Address	Enter the real remote IP address of GRE tunnel.
Local IP Address	Set the local IP address.
Local Virtual IP Address	Set the local tunnel IP address of GRE tunnel.
Netmask	Set the local netmask.
Peer Virtual IP Address	Enter remote tunnel IP address of GRE tunnel.
Global Traffic Forwarding	All the data traffic will be sent out via GRE tunnel when this function is enabled.
Remote Subnet	Enter the remote subnet IP address of GRE tunnel.
Remote Netmask	Enter the remote netmask of GRE tunnel.
MTU	Enter the maximum transmission unit. Range: 64-1500.
Key	Set GRE tunnel key.
Enable NAT	Enable NAT traversal function.

Table 3-3-6-4 GRE Parameters

### 3.3.6.4 L2TP

Layer Two Tunneling Protocol (L2TP) is an extension of the Point-to-Point Tunneling Protocol (PPTP) used by an Internet service provider (ISP) to enable the operation of a virtual private network (VPN) over the Internet.

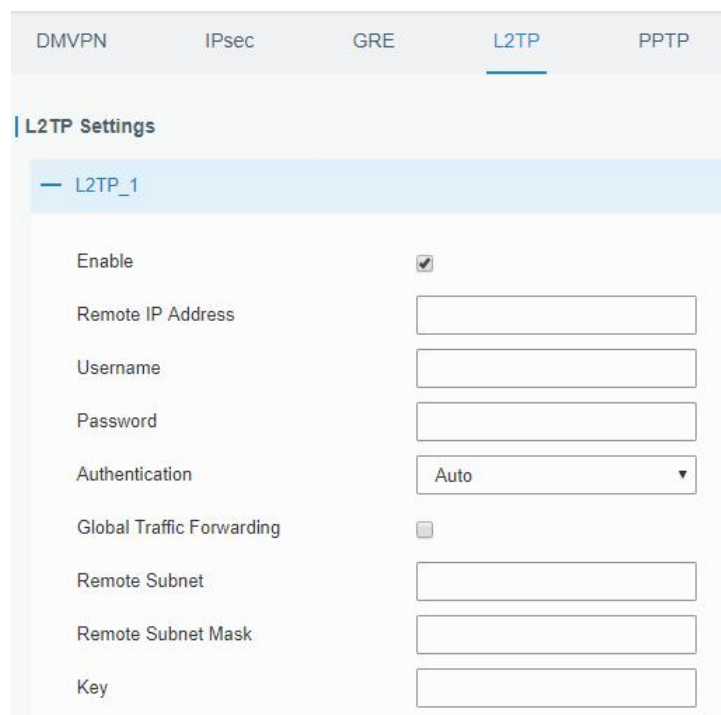

Figure 3-3-6-6

L2TP	
Item	Description
Enable	Check to enable L2TP function.
Remote IP Address	Enter the public IP address or domain name of L2TP server.
Username	Enter the username that L2TP server provides.
Password	Enter the password that L2TP server provides.

Authentication	Select from "Auto", "PAP", "CHAP", "MS-CHAPv1" and "MS-CHAPv2".
Global Traffic Forwarding	All of the data traffic will be sent out via L2TP tunnel after this function is enabled.
Remote Subnet	Enter the remote IP address that L2TP protects.
Remote Subnet Mask	Enter the remote netmask that L2TP protects.
Key	Enter the password of L2TP tunnel.

Table 3-3-6-5 L2TP Parameters

Figure 3-3-6-7

Advanced Settings	
Item	Description
Local IP Address	Set tunnel IP address of L2TP client. Client will obtain tunnel IP address automatically from the server when it's null.
Peer IP Address	Enter tunnel IP address of L2TP server.
Enable NAT	Enable NAT traversal function.
Enable MPPE	Enable MPPE encryption.
Address/Control Compression	For PPP initialization. User can keep the default option.
Protocol Field Compression	For PPP initialization. User can keep the default option.
Asyncmap Value	One of the PPP protocol initialization strings. User can keep the default value. Range: 0-ffffff.
MRU	Set the maximum receive unit. Range: 64-1500.
MTU	Set the maximum transmission unit. Range: 64-1500
Link Detection Interval	Set the link detection interval time to ensure tunnel

(s)	connection. Range: 0-600.
Max Retries	Set the maximum times of retry to detect the L2TP connection failure. Range: 0-10.
Expert Options	User can enter some other PPP initialization strings in this field and separate the strings with blank space.

Table 3-3-6-6 L2TP Parameters

### 3.3.6.5 PPTP

Point-to-Point Tunneling Protocol (PPTP) is a protocol that allows corporations to extend their own corporate network through private "tunnels" over the public Internet. Effectively, a corporation uses a wide-area network as a single large local area network.

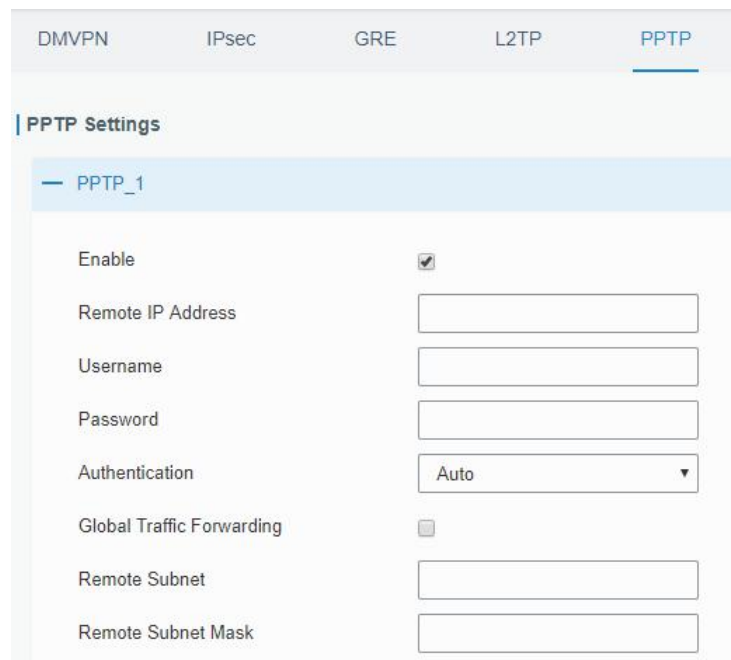

Figure 3-3-6-8

PPTP	
Item	Description
Enable	Enable PPTP client. A maximum of 3 tunnels is allowed.
Remote IP Address	Enter the public IP address or domain name of PPTP server.
Username	Enter the username that PPTP server provides.
Password	Enter the password that PPTP server provides.
Authentication	Select from "Auto", "PAP", "CHAP", "MS-CHAPv1", and "MS-CHAPv2".
Global Traffic Forwarding	All of the data traffic will be sent out via PPTP tunnel once enable this function.
Remote Subnet	Set the peer subnet of PPTP.
Remote Subnet Mask	Set the netmask of peer PPTP server.

Table 3-3-6-7 PPTP Parameters

Advanced Settings	<input checked="" type="checkbox"/>
Local IP Address	<input type="text"/>
Peer IP Address	<input type="text"/>
Enable NAT	<input checked="" type="checkbox"/>
Enable MPPE	<input checked="" type="checkbox"/>
Address/Control Compression	<input type="checkbox"/>
Protocol Field Compression	<input type="checkbox"/>
Asyncmap Value	<input type="text" value="ffffff"/>
MRU	<input type="text" value="1500"/>
MTU	<input type="text" value="1500"/>
Link Detection Interval(s)	<input type="text" value="60"/>
Max Retries	<input type="text" value="0"/>
Expert Options	<input type="text"/>

Figure 3-3-6-9

PPTP Advanced Settings	
Item	Description
Local IP Address	Set IP address of PPTP client.
Peer IP Address	Enter tunnel IP address of PPTP server.
Enable NAT	Enable the NAT faction of PPTP.
Enable MPPE	Enable MPPE encryption.
Address/Control Compression	For PPP initialization. User can keep the default option.
Protocol Field Compression	For PPP initialization. User can keep the default option.
Asyncmap Value	One of the PPP protocol initialization strings. User can keep the default value. Range: 0-ffffff.
MRU	Enter the maximum receive unit. Range: 0-1500.
MTU	Enter the maximum transmission unit. Range: 0-1500.
Link Detection Interval (s)	Set the link detection interval time to ensure tunnel connection. Range: 0-600.
Max Retries	Set the maximum times of retrying to detect the PPTP connection failure. Range: 0-10.
Expert Options	User can enter some other PPP initialization strings in this field and separate the strings with blank space.

Table 3-3-6-8 PPTP Parameters

### 3.3.6.6 OpenVPN Client

OpenVPN is an open source virtual private network (VPN) product that offers a simplified security framework, modular network design, and cross-platform portability.

Advantages of OpenVPN include:

- Security provisions that function against both active and passive attacks.
- Compatibility with all major operating systems.
- High speed (1.4 megabytes per second typically).
- Ability to configure multiple servers to handle numerous connections simultaneously.
- All encryption and authentication features of the OpenSSL library.
- Advanced bandwidth management.
- A variety of tunneling options.
- Compatibility with smart cards that support the Windows Crypt application program interface (API).

The screenshot displays the 'OpenVPN Client Settings' page. At the top, there are navigation tabs: DMVPN, IPsec, GRE, L2TP, PPTP, **OpenVPN Client**, OpenVPN Server, and Certificatio. Below the tabs, the page title is 'OpenVPN Client Settings'. A section header 'OpenVPN\_1' is visible. The settings are organized into a list of fields:

- Enable:
- Protocol:
- Remote IP Address:
- Port:
- Interface:
- Authentication:
- Local Tunnel IP:
- Remote Tunnel IP:
- Enable NAT:
- Compression:
- Link Detection Interval(s):
- Link Detection Timeout(s):
- Cipher:
- MTU:
- Max Frame Size:
- Verbose Level:
- Expert Options:

At the bottom, there is a 'Local Route' section with a table structure:

Subnet	Subnet Mask	Operation
		<input type="button" value="+"/>

Figure 3-3-6-10

OpenVPN Client	
Item	Description
Enable	Enable OpenVPN client. A maximum of 3 tunnels is allowed.



Protocol	Select from "UDP" and "TCP".
Remote IP Address	Enter remote OpenVPN server's IP address or domain name.
Port	Enter the listening port number of remote OpenVPN server. Range: 1-65535.
Interface	Select from "tun" and "tap".
Authentication	Select from "None", "Pre-shared", "Username/Password", "X.509 cert", and "X.509 cert+user".
Local Tunnel IP	Set local tunnel address.
Remote Tunnel IP	Enter remote tunnel address.
Global Traffic Forwarding	All the data traffic will be sent out via OpenVPN tunnel when this function is enabled.
Enable TLS Authentication	Check to enable TLS authentication.
Username	Enter username provided by OpenVPN server.
Password	Enter password provided by OpenVPN server.
Enable NAT	Enable NAT traversal function.
Compression	Select LZO to compress data.
Link Detection Interval (s)	Set link detection interval time to ensure tunnel connection. Range: 10-1800.
Link Detection Timeout (s)	Set link detection timeout. OpenVPN will be reestablished after timeout. Range: 60-3600.
Cipher	Select from "NONE", "BF-CBC", "DE-CBC", "DES-EDE3-CBC", "AES-128-CBC", "AES-192-CBC" and "AES-256-CBC".
MTU	Enter the maximum transmission unit. Range: 128-1500.
Max Frame Size	Set the maximum frame size. Range: 128-1500.
Verbose Level	Select from "ERROR", "WARNING", "NOTICE" and "DEBUG".
Expert Options	User can enter some other PPP initialization strings in this field and separate the strings with blank space.
<b>Local Route</b>	
Subnet	Set the local route's IP address.
Subnet Mask	Set the local route's netmask.

Table 3-3-6-9 OpenVPN Client Parameters

### 3.3.6.7 OpenVPN Server

UG67 supports OpenVPN server to create secure point-to-point or site-to-site connections in routed or bridged configurations and remote access facilities.

DMVPN	IPsec	GRE	L2TP	PPTP	OpenVPN Client	OpenVPN Server
<b>OpenVPN Server Settings</b>						
Enable	<input type="checkbox"/>					
Protocol	UDP					
Port	1194					
Listening IP						
Interface	tun					
Authentication	None					
Local Virtual IP						
Remote Virtual IP						
Enable NAT	<input checked="" type="checkbox"/>					
Compression	LZO					
Link Detection Interval	60					
Cipher	None					
MTU	1500					
Max Frame Size	1500					
Verbose Level	ERROR					
Expert Options						

Figure 3-3-6-11

Local Route		
Subnet	Netmask	Operation
		+

Account		
Username	Password	Operation
		+

Figure 3-3-6-12

OpenVPN Server	
Item	Description
Enable	Enable/disable OpenVPN server.
Protocol	Select from TCP and UDP.
Port	Fill in listening port number. Range: 1-65535.
Listening IP	Enter WAN IP address or LAN IP address. Leaving it blank refers to all active WAN IP and LAN IP address.
Interface	Select from "tun" and "tap".
Authentication	Select from "None", "Pre-shared", "Username/Password", "X.509 cert" and "X.509 cert +user".
Local Virtual IP	The local tunnel address of OpenVPN's tunnel.

Remote Virtual IP	The remote tunnel address of OpenVPN's tunnel.
Client Subnet	Local subnet IP address of OpenVPN client.
Client Netmask	Local netmask of OpenVPN client.
Renegotiation Interval(s)	Set interval for renegotiation. Range: 0-86400.
Max Clients	Maximum OpenVPN client number. Range: 1-128.
Enable CRL	Enable CRL
Enable Client to Client	Allow access between different OpenVPN clients.
Enable Dup Client	Allow multiple users to use the same certification.
Enable NAT	Check to enable the NAT traversal function.
Compression	Select "LZO" to compress data.
Link Detection Interval	Set link detection interval time to ensure tunnel connection. Range: 10-1800.
Cipher	Select from "NONE", "BF-CBC", "DES-CBC", "DES-EDE3-CBC", "AES-128-CBC", "AES-192-CBC" and "AES-256-CBC".
MTU	Enter the maximum transmission unit. Range: 64-1500.
Max Frame Size	Set the maximum frame size. Range: 64-1500.
Verbose Level	Select from "ERROR", "WARNING", "NOTICE" and "DEBUG".
Expert Options	User can enter some other PPP initialization strings in this field and separate the strings with blank space.
<b>Local Route</b>	
Subnet	The real local IP address of OpenVPN client.
Netmask	The real local netmask of OpenVPN client.
<b>Account</b>	
Username & Password	Set username and password for OpenVPN client.

Table 3-3-6-10 OpenVPN Server Parameters

### 3.3.6.8 Certifications

User can import/export certificate and key files for OpenVPN and IPsec on this page.

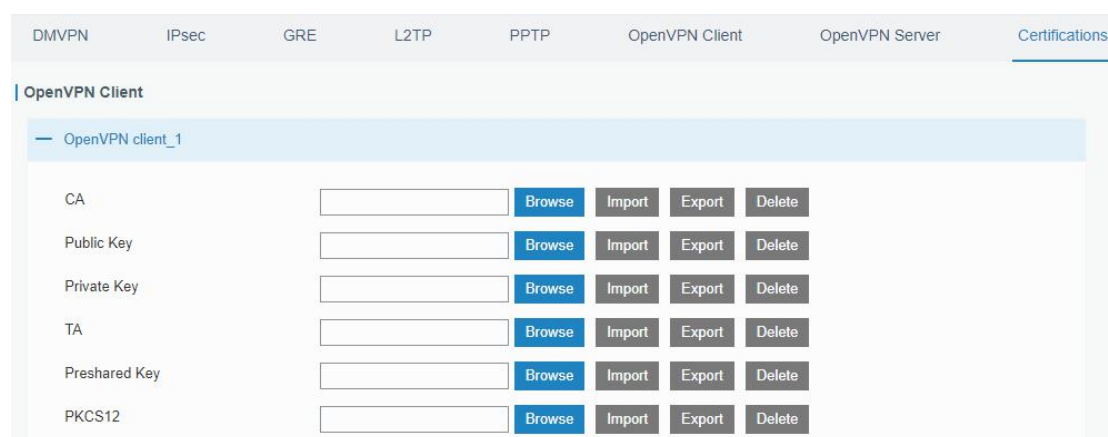

Figure 3-3-6-13

OpenVPN Client	
Item	Description
CA	Import/Export CA certificate file.

Public Key	Import/Export public key file.
Private Key	Import/Export private key file.
TA	Import/Export TA key file.
Preshared Key	Import/Export static key file.
PKCS12	Import/Export PKCS12 certificate file.

Table 3-3-6-11 OpenVPN Client Certification Parameters

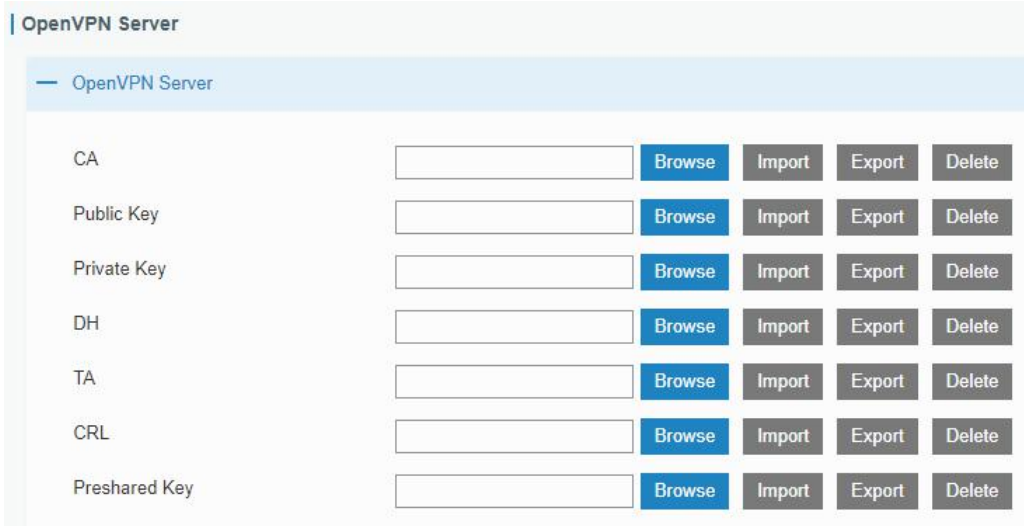

Figure 3-3-6-14

OpenVPN Server	
Item	Description
CA	Import/Export CA certificate file.
Public Key	Import/Export public key file.
Private Key	Import/Export private key file.
DH	Import/Export DH key file.
TA	Import/Export TA key file.
CRL	Import/Export CRL.
Preshared Key	Import/Export static key file.

Table 3-3-6-12 OpenVPN Server Parameters

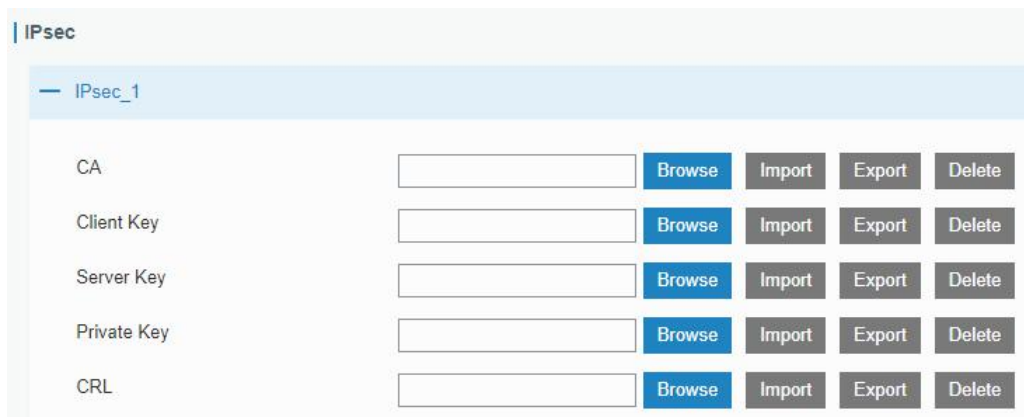

Figure 3-3-6-15

IPsec	
Item	Description
CA	Import/Export CA certificate.
Client Key	Import/Export client key.
Server Key	Import/Export server key.
Private Key	Import/Export private key.
CRL	Import/Export certificate recovery list.

Table 3-3-6-13 IPsec Parameters

### 3.4 System

This section describes how to configure general settings, such as administration account, access service, system time, common user management, SNMP, event alarms, etc.

#### 3.4.1 General Settings

##### 3.4.1.1 General

General settings include system info, access service and HTTPS certificates.

Figure 3-4-1-1

General		
Item	Description	Default
<b>System</b>		
Hostname	User-defined gateway name, needs to start with a letter.	GATEWAY

Web Login Timeout (s)	You need to log in again if it times out. Range: 100-3600.	1800
<b>Access Service</b>		
Port	Set port number of the services. Range: 1-65535.	--
HTTP	Users can log in the device locally via HTTP to access and control it through Web after the option is checked.	80
HTTPS	Users can log in the device locally and remotely via HTTPS to access and control it through Web after option is checked.	443
TELNET	Users can log in the device locally and remotely via TELNET to access and control it through Web after option is checked.	23
SSH	Users can log in the device locally and remotely via SSH after the option is checked.	22
<b>HTTPS Certificates</b>		
Certificate	Click "Browse" button, choose certificate file on the PC, and then click "Import" button to upload the file into gateway. Click "Export" button will export the file to the PC. Click "Delete" button will delete the file.	--
Key	Click "Browse" button, choose key file on the PC, and then click "Import" button to upload the file into gateway. Click "Export" button will export file to the PC. Click "Delete" button will delete the file.	--

Table 3-4-1-1 General Setting Parameters

### 3.4.1.2 System Time

This section explains how to set the system time including time zone and time synchronization type.

**Note:** to ensure that the gateway runs with the correct time, it's recommended that you set the system time when configuring the gateway.

The screenshot displays the 'System Time' configuration page. At the top, there are navigation tabs: 'General', 'System Time' (which is active), 'SMTP', 'Phone', and 'Email'. Below the tabs, the 'System Time Settings' section is visible. It includes the following fields:

- Current Time:** 2019-06-12 20:34:32 Wed
- Time Zone:** A dropdown menu showing '8 China (Beijing)'.
- Sync Type:** A dropdown menu showing 'Sync with Browser'.
- Browser Time:** 2019-06-12 20:34:32 Wed

Figure 3-4-1-2

The screenshot shows the 'System Time' settings page. The 'Current Time' is 2019-06-12 20:33:59 Wed. The 'Time Zone' is set to '8 China (Beijing)'. The 'Sync Type' is 'Set up Manually'. The 'Date' is 2019-06-12 and the 'Time' is 20:33:59.

Figure 3-4-1-3

The screenshot shows the 'System Time' settings page. The 'Current Time' is 2019-06-12 20:33:36 Wed. The 'Time Zone' is '8 China (Beijing)'. The 'Sync Type' is 'Sync with NTP Server'. The 'NTP Server Address' is 1.cn.pool.ntp.org. The 'Enable NTP Server' checkbox is unchecked.

Figure 3-4-1-4

System Time	
Item	Description
Current Time	Show the current system time.
Time Zone	Click the drop down list to select the time zone you are in.
Sync Type	Click the drop down list to select the time synchronization type.
Sync with Browser	Synchronize time with browser.
Browser Time	Show the current time of browser.
Set up Manually	Manually configure the system time.
Sync with NTP Server	Synchronize time with NTP server so as to achieve time synchronization of all devices equipped with a clock on network.
Sync with NTP Server	
NTP Server Address	Set NTP server address (domain name/IP).
Enable NTP Server	NTP client on the network can achieve time synchronization with gateway after "Enable NTP Server" option is checked.

Table 3-4-1-2 System Time Parameters

### 3.4.1.3 SMTP

SMTP, short for Simple Mail Transfer Protocol, is a TCP/IP protocol used in sending and receiving e-mail. This section describes how to configure email settings.

Figure 3-4-1-5

SMTP	
Item	Description
<b>SMTP Client Settings</b>	
Enable	Enable or disable SMTP client function.
Email Address	Enter the sender's email account.
Password	Enter the sender's email password.
SMTP Server Address	Enter SMTP server's domain name.
Port	Enter SMTP server port. Range: 1-65535.
Enable TLS	Enable or disable TLS encryption.

Table 3-4-1-3 SMTP Setting

### Related Topics

[Events Setting](#)

### 3.4.1.4 Phone

Phone settings involve in call/SMS trigger and SMS alarm for events.

1. Add phone list.
2. Select phone numbers and add them to the phone group.
3. Go to "Network > Interface > Cellular > Connection Mode > Connect on Demand > Trigger by Call / Trigger by SMS" or go to "System > Events > Event Settings > SMS" and then select the phone group ID.



Figure 3-4-1-6

Phone	
Item	Description
<b>Phone Number List</b>	
Number	Enter the telephone number. Digits, "+" and "-" are allowed.
Description	The description of the telephone number.
<b>Phone Group List</b>	
Group ID	Set number for phone group. Range: 1-100.
Description	The description of the phone group.
List	Show the phone list.
Selected	Show the selected phone number.

Table 3-4-1-4 Phone Settings

## Related Topic

[Connect on Demand](#)

### 3.4.1.5 Email

Email settings involve email alarm for events.

1. Add email list.
2. Select email addresses and add them to the phone group.
3. Go to "System > Events > Event Settings > Email" and then select the email group ID.

Figure 3-4-1-7

Email	
Item	Description
<b>Email List</b>	
Email Address	Enter the Email address.
Description	The description of the Email address.
<b>Email Group List</b>	
Group ID	Set number for email group. Range: 1-100.
Description	The description of the Email group.
List	Show the Email address list.
Selected	Show the selected Email address.

Table 3-4-1-5 Email Settings

### 3.4.2 User Management

#### 3.4.2.1 Account

Here you can change the login username and password of the administrator.

**Note: it is strongly recommended that you modify them for the sake of security.**

Figure 3-4-2-1

Account	
Item	Description
Username	Enter a new username. You can use characters such as a-z, 0-9, "_", "-", "\$". The first character can't be a digit.
Old Password	Enter the old password.
New Password	Enter a new password.
Confirm New Password	Enter the new password again.

Table 3-4-2-1 Account Information

### 3.4.2.2 User Management

This section describes how to create common user accounts.

The common user permission includes Read-Only and Read-Write.

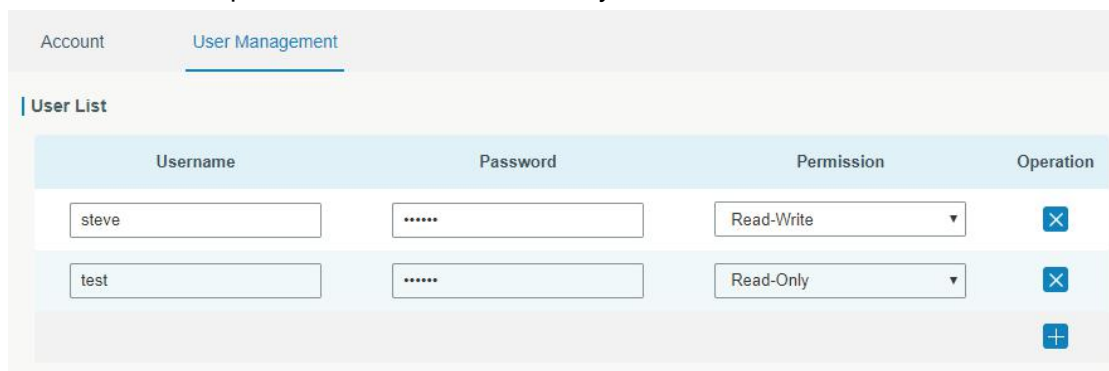

Figure 3-4-2-2

User Management	
Item	Description
Username	Enter a new username. You can use characters such as a-z, 0-9, "_", "-", "\$". The first character can't be a digit.
Password	Set password.
Permission	Select user permission from "Read-Only" and "Read-Write". <ul style="list-style-type: none"> <li>- Read-Only: users can only view the configuration of gateway in this level.</li> <li>- Read-Write: users can view and set the configuration of gateway in this level.</li> </ul>

Table 3-4-2-2 User Management

### 3.4.3 SNMP

SNMP is widely used in network management for network monitoring. SNMP exposes management data with variables form in managed system. The system is organized in a management information base (MIB) which describes the system status and configuration. These variables can be remotely queried by managing applications.

Configuring SNMP in networking, NMS, and a management program of SNMP should be set up at the Manager.

Configuration steps are listed as below for achieving query from NMS:

1. Enable SNMP setting.
2. Download MIB file and load it into NMS.
3. Configure MIB View.
4. Configure VCAM.

### 3.4.3.1 SNMP

UG67 supports SNMPv1, SNMPv2c and SNMPv3 version. SNMPv1 and SNMPv2c employ community name authentication. SNMPv3 employs authentication encryption by username and password.

Figure 3-4-3-1

SNMP Settings	
Item	Description
Enable	Enable or disable SNMP function.
Port	Set SNMP listened port. Range: 1-65535. The default port is 161.
SNMP Version	Select SNMP version; support SNMP v1/v2c/v3.
Location Information	Fill in the location information.
Contact Information	Fill in the contact information.

Table 3-4-3-1 SNMP Parameters

### 3.4.3.2 MIB View

This section explains how to configure MIB view for the objects.

Figure 3-4-3-2

MIB View	
Item	Description
View Name	Set MIB view's name.
View Filter	Select from "Included" and "Excluded".
View OID	Enter the OID number.
Included	You can query all nodes within the specified MIB node.
Excluded	You can query all nodes except for the specified MIB node.

Table 3-4-3-2 MIB View Parameters

### 3.4.3.3 VACM

This section describes how to configure VACM parameters.

Figure 3-4-3-3

VACM	
Item	Description
<b>SNMP v1 &amp; v2 User List</b>	
Community	Set the community name.
Permission	Select from "Read-Only" and "Read-Write".
MIB View	Select an MIB view to set permissions from the MIB view list.
Network	The IP address and bits of the external network accessing the MIB view.

Read-Write	The permission of the specified MIB node is read and write.
Read-Only	The permission of the specified MIB node is read only.
<b>SNMP v3 User List</b>	
Group Name	Set the name of SNMPv3 group.
Security Level	Select from "NoAuth/NoPriv", "Auth/NoPriv", and "Auth/Priv".
Read-Only View	Select an MIB view to set permission as "Read-only" from the MIB view list.
Read-Write View	Select an MIB view to set permission as "Read-write" from the MIB view list.
Inform View	Select an MIB view to set permission as "Inform" from the MIB view list.

Table 3-4-3-3 VACM Parameters

### 3.4.3.4 Trap

This section explains how to enable network monitoring by SNMP trap.

Figure 3-4-3-4

SNMP Trap	
Item	Description
Enable	Enable or disable SNMP Trap function.
SNMP Version	Select SNMP version; support SNMP v1/v2c/v3.
Server Address	Fill in NMS's IP address or domain name.
Port	Fill in UDP port. Port range is 1-65535. The default port is 162.
Name	Fill in the group name when using SNMP v1/v2c; fill in the username when using SNMP v3.
Auth/Priv Mode	Select from "NoAuth & No Priv", "Auth & NoPriv", and "Auth & Priv".

Table 3-4-3-4 Trap Parameters

### 3.4.3.5 MIB

This section describes how to download MIB files.

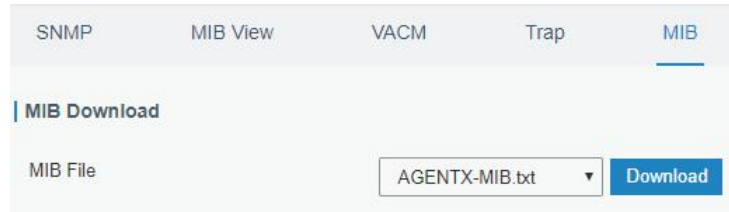

Figure 3-4-3-5

MIB	
Item	Description
MIB File	Select the MIB file you need.
Download	Click "Download" button to download the MIB file to PC.

Table 3-4-3-5 MIB Download

### 3.4.5 Device Management

You can connect the device to the DeviceHub on this page so as to manage the gateway centrally and remotely.

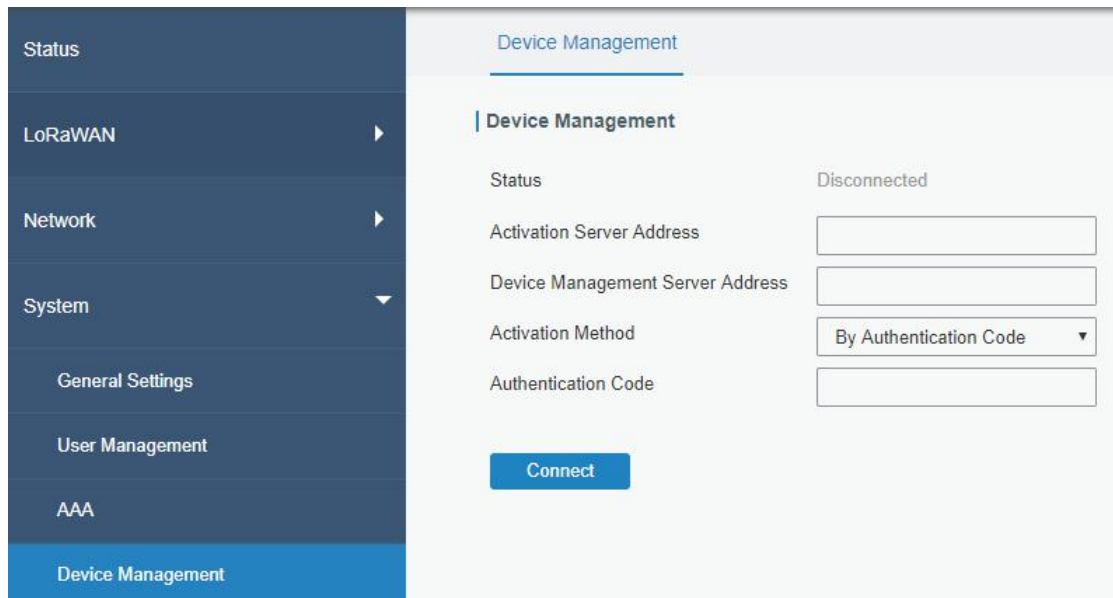

Figure 3-4-5-1

DeviceHub	
Item	Description
Status	Show the connection status between the gateway and the DeviceHub.
Disconnected	Click this button to disconnect the gateway from the DeviceHub.
Activation Server Address	IP address or domain of the DeviceHub.
DeviceHub Server Address	The URL address for the device to connect to the DeviceHub, e.g. http://220.82.63.79:8080/acs.
Activation Method	Select activation method to connect the gateway to the

	DeviceHub server, options are "By Authentication ID" and "By ID".
Authentication Code	Fill in the authentication code generated from the DeviceHub.
ID	Fill in the registered DeviceHub account (email) and password.
Password	

Table 3-4-5-1

### 3.4.6 Events

Event feature is capable of sending alerts by Email when certain system events occur.

#### 3.4.6.1 Events

You can view alarm messages on this page.

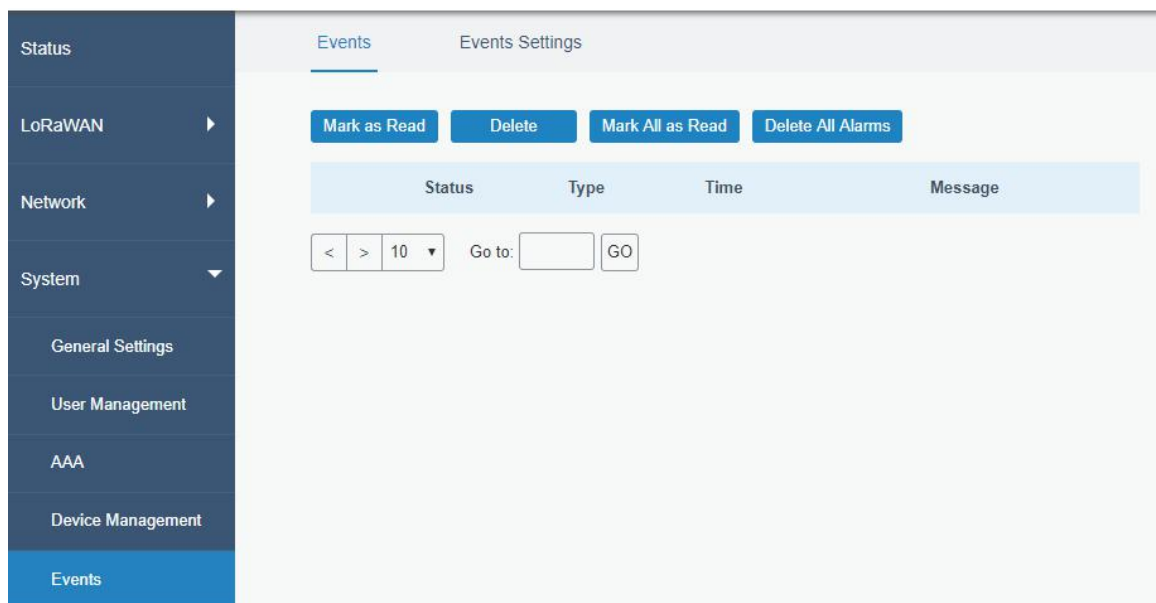

Figure 3-4-6-1

Events	
Item	Description
Mark as Read	Mark the selected event alarm as read.
Delete	Delete the selected event alarm.
Mark All as Read	Mark all event alarms as read.
Delete All Alarms	Delete all event alarms.
Status	Show the reading status of the event alarms, such as "Read" and "Unread".
Type	Show the event type that should be alarmed.
Time	Show the alarm time.
Message	Show the alarm content.

Table 3-4-6-1 Events Parameters



### 3.4.6.2 Events Settings

In this section, you can decide what events to record and whether you want to receive email and SMS notifications when any change occurs.

Events
Events Settings

**Events Settings**

Enable

Phone Group List

Email Group List

Events	Record	Email Email Setting	SMS SMS Setting
Cellular Up	<input type="checkbox"/>	<input type="checkbox"/>	<input type="checkbox"/>
Cellular Down	<input type="checkbox"/>	<input type="checkbox"/>	<input type="checkbox"/>
WAN Up	<input type="checkbox"/>	<input type="checkbox"/>	<input type="checkbox"/>
WAN Down	<input type="checkbox"/>	<input type="checkbox"/>	<input type="checkbox"/>
VPN Up	<input type="checkbox"/>	<input type="checkbox"/>	<input type="checkbox"/>
VPN Down	<input type="checkbox"/>	<input type="checkbox"/>	<input type="checkbox"/>

Figure 3-4-6-2

Event Settings	
Item	Description
Enable	Check to enable "Events Settings".
Cellular Up	Cellular network is connected.
Cellular Down	Cellular network is disconnected.
WAN Up	Ethernet cable is connected to WAN port.
WAN Down	Ethernet cable is disconnected to WAN port.
VPN Up	VPN is connected.
VPN Down	VPN is disconnected.
Record	The relevant content of event alarm will be recorded on "Event" page if this option is checked.
Email	The relevant content of event alarm will be sent out via email if this option is checked.
Email Setting	Click and you will be redirected to the page "Email" to configure the Email group.
SMS	The relevant content of event alarm will be sent out via SMS if this option is checked.
SMS Setting	Click and you will be redirected to the page of "Phone" to configure phone group list.

Phone Group List	Select phone group to receive SMS alarm.
Email Group List	Select Email group to receive Email alarm.

Table 3-4-6-2 Events Parameters

**Related Topics**

[Email Setting](#)

[Phone Setting](#)

**3.5 Maintenance**

This section describes system maintenance tools and management.

**3.5.1 Tools**

Troubleshooting tools includes ping and traceroute.

**3.5.1.1 Ping**

Ping tool is engineered to ping outer network.

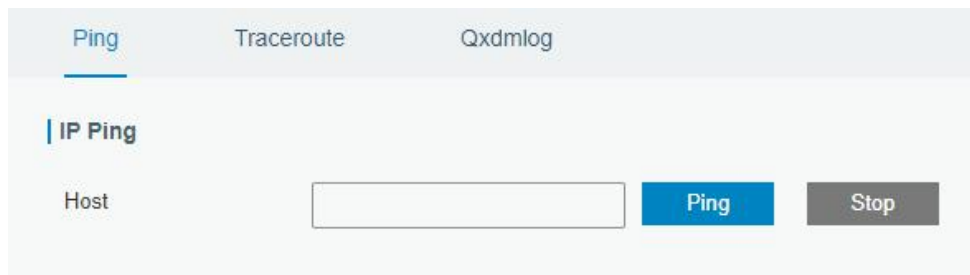

Figure 3-5-1-1

PING	
Item	Description
Host	Ping outer network from the gateway.

Table 3-5-1-1 IP Ping Parameters

**3.5.1.2 Traceroute**

Traceroute tool is used for troubleshooting network routing failures.

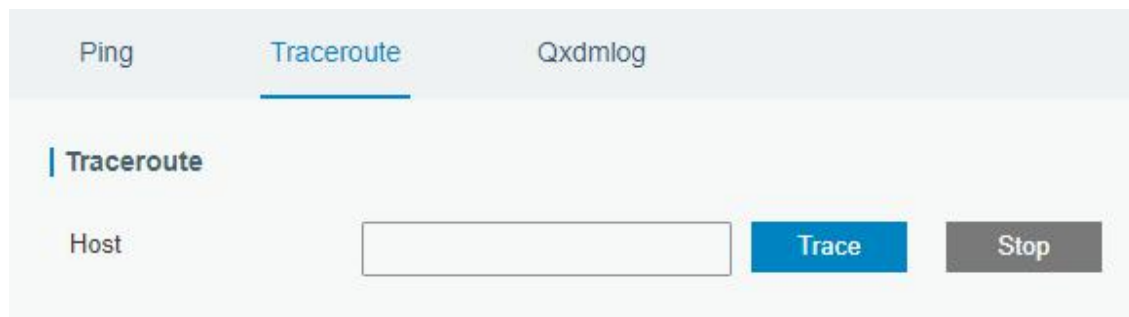

Figure 3-5-1-2

Traceroute	
Item	Description
Host	Address of the destination host to be detected.

Table 3-5-1-2 Traceroute Parameters

### 3.5.2 Schedule

This section explains how to configure scheduled reboot on the gateway.

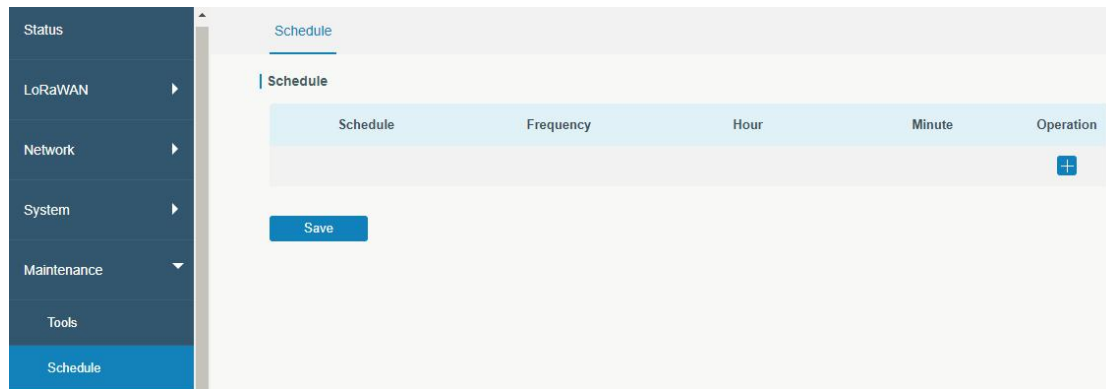

Figure 3-5-2-1

Schedule	
Item	Description
Schedule	Select schedule type.
Reboot	Reboot the gateway regularly.
Frequency	Select the frequency to execute the schedule.
Hour & Minute	Select the time to execute the schedule.

Table 3-5-2-1 Schedule Parameters

### 3.5.3 Log

The system log contains a record of informational, error and warning events that indicates how the system processes. By reviewing the data contained in the log, an administrator or user troubleshooting the system can identify the cause of a problem or whether the system processes are loading successfully. Remote log server is feasible, and gateway will upload all system logs to remote log server such as Syslog Watcher.

#### 3.5.3.1 System Log

This section describes how to download log file and view the recent log on web.

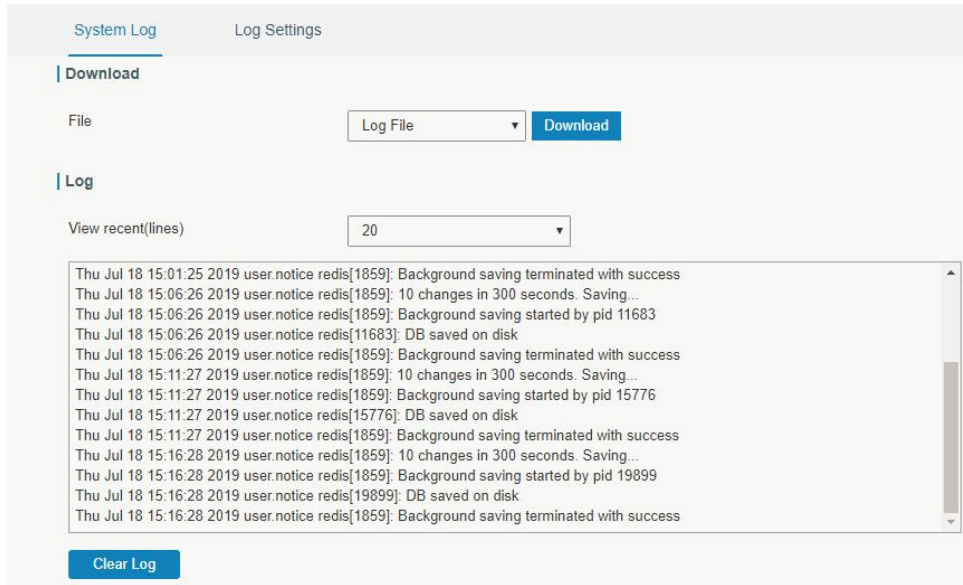

Figure 3-5-3-1

System Log	
Item	Description
Download	Download log file.
View recent (lines)	View the specified lines of system log.
Clear Log	Clear the current system log.

Table 3-5-3-1 System Log Parameters

### 3.5.3.2 Log Settings

This section explains how to enable remote log server and local log setting.

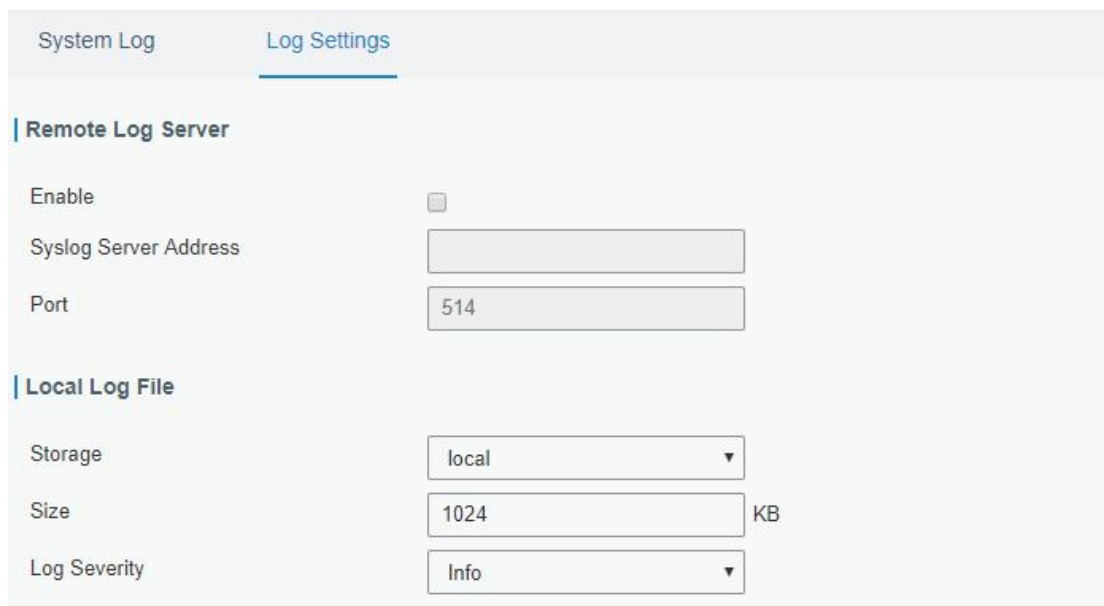

Figure 3-5-3-2

Log Settings	
Item	Description
<b>Remote Log Server</b>	
Enable	With "Remote Log Server" enabled, gateway will send all system logs to the remote server.
Syslog Server Address	Fill in the remote system log server address (IP/domain name).
Port	Fill in the remote system log server port.
<b>Local Log File</b>	
Storage	User can store the log file in memory or TF card.
Size	Set the size of the log file to be stored.
Log Severity	The list of severities follows the syslog protocol.

Table 3-5-3-2 System Log Parameters

### 3.5.4 Upgrade

This section describes how to upgrade the gateway firmware via web. Generally you don't need to do the firmware upgrade.

Note: any operation on web page is not allowed during firmware upgrade, otherwise the upgrade will be interrupted, or even the device will break down.

Figure 3-5-4-1

Upgrade	
Item	Description
Firmware Version	Show the current firmware version.
Reset Configuration to Factory Default	When this option is checked, the gateway will be reset to factory defaults after upgrade.
Upgrade Firmware	Click "Browse" button to select the new firmware file, and click "Upgrade" to upgrade firmware.

Table 3-5-4-1 Upgrade Parameters

### Related Configuration Example

[Firmware Upgrade](#)

### 3.5.5 Backup and Restore

This section explains how to create a complete backup of the system configurations to a file, restore the config file to the gateway and reset to factory defaults.

The screenshot shows a web interface titled "Backup and Restore". It contains three main sections:

- Restore Config:** A section with a "Config File" input field, a blue "Browse" button, and a grey "Import" button.
- Backup Running-config:** A section with a blue "Backup" button.
- Restore Factory Defaults:** A section with a red "Reset" button.

Figure 3-5-5-1

Backup and Restore	
Item	Description
Config File	Click "Browse" button to select configuration file, and then click "Import" button to upload the configuration file to the gateway.
Backup	Click "Backup" to export the current configuration file to the PC.
Reset	Click "Reset" button to reset factory default settings. gateway will restart after reset process is done.

Table 3-5-5-1 Backup and Restore Parameters

### Related Configuration Example

[Restore Factory Defaults](#)

### 3.5.6 Reboot

On this page you can reboot the gateway and return to the login page. We strongly recommend clicking "Save" button before rebooting the gateway so as to avoid losing the new configuration.

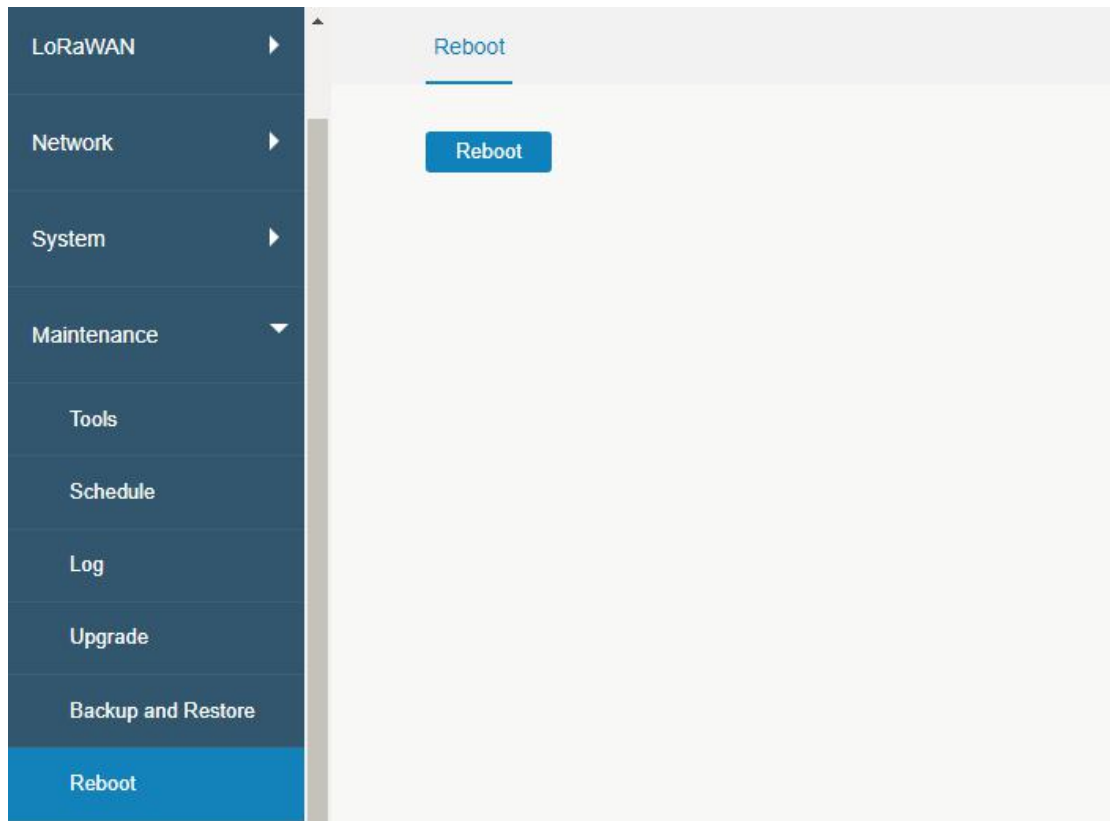

Figure 3-5-6-1

## 3.6 APP

### 3.6.1 Python

Python is an object-oriented programming language that has gained popularity because of its clear syntax and readability.

As an interpreted language, Python has a design philosophy that emphasizes code readability, notably using whitespace indentation to delimit code blocks rather than curly brackets or keywords, and a syntax that allows programmers to express concepts in fewer lines of code than it's used in other languages such as C++ or Java. The language provides constructs and intends to enable writing clear programs on both small and large scale.

Users can use Python to quickly generate the prototype of the program, which can be the final interface of the program, rewrite it with a more appropriate language, and then encapsulate the extended class library that Python can call.

This section describes how to view the relevant running status such as App-manager, SDK version, extended storage, etc. Also you can change the App-manager configuration, and import the Python App package from here.

### 3.6.1.1 Python

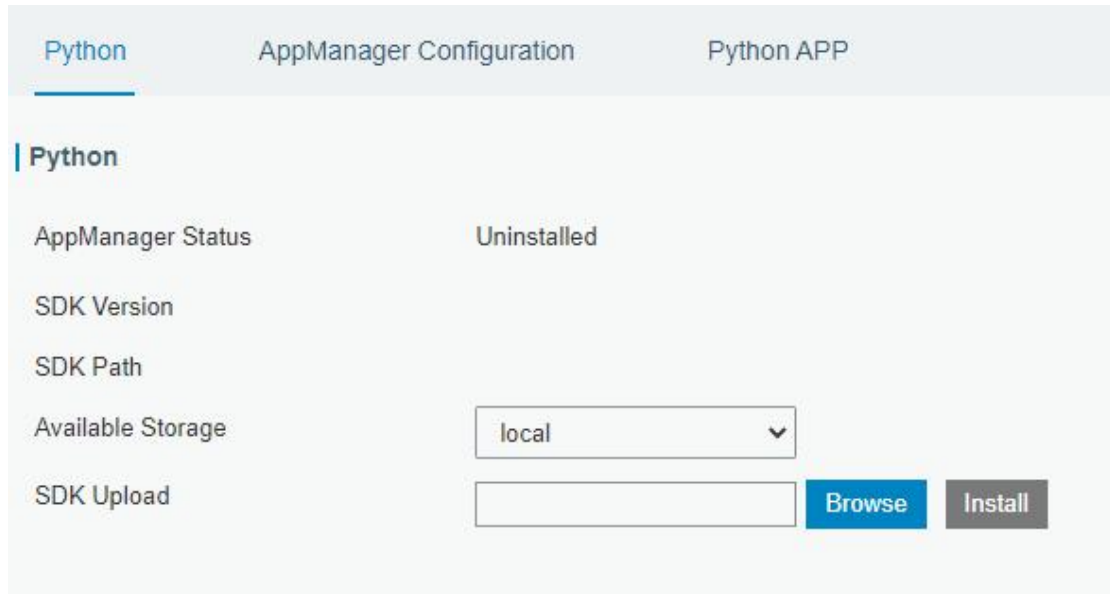

Figure 3-6-1-1

Python	
Item	Description
AppManager Status	Show AppManager's running status, like "Uninstalled", "Running" or "Stopped".
SDK Version	Show the version of the installed SDK.
SDK Path	Show the SDK installation path.
Available Storage	Select available storage to install SDK.
SDK Upload	Upload and install SDK for Python.
Uninstall	Uninstall SDK.
View	View application status managed by AppManager.

Table 3-6-1-1 Python Parameters

### 3.6.1.2 App Manager Configuration

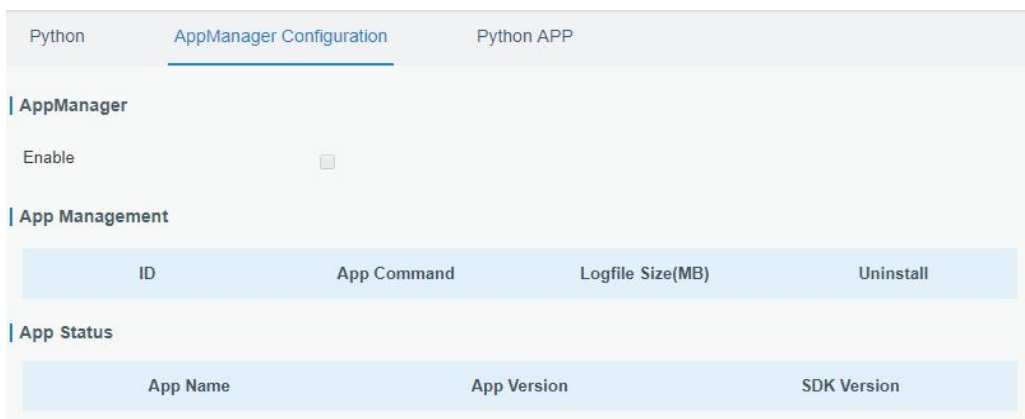

Figure 3-6-1-2



AppManager Configuration	
Item	Description
Enable	After enabling Python AppManager, user can click "View" button on the "Python" webpage to view the application status managed by AppManager.
App Management	
ID	Show the ID of the imported App.
App Command	Show the name of the imported App.
Logfile Size(MB)	User-defined Logfile size. Range: 1-50.
Uninstall	Uninstall APP.
App Status	
App Name	Show the name of the imported App.
App Version	Show the version of the imported App.
SDK Version	Show the SDK version which the imported App is based on.

Table 3-6-1-2 APP Manager Parameters

### 3.6.1.3 Python App

Figure 3-6-1-3

Python APP	
Item	Description
App Package	Select App package and import.
App Name	Select App to import configuration.
App Configuration	Select configuration file and import.
Debug File	Export script file.
Debug Script	Select Python script to be debugged and import.

Table 3-6-1-3 APP Parameters

## Chapter 4 Application Examples

### 4.1 Packet Forwarder Configuration

1. Go to "Packet Forwarder" > "General".

The screenshot shows the 'Packet Forwarder' configuration page in the Milesight IoT web interface. The left sidebar contains navigation options: Status, Packet Forwarder, Network Server, Network, System, Maintenance, and APP. The main content area is divided into tabs: General, Radios, Advanced, Custom, and Traffic. The 'General' tab is active, showing 'General Setting' with fields for Gateway EUI (24E124FFFEF0E225), Gateway ID (24E124FFFEF0E225), and Frequency-Sync (Disabled). Below this is a 'Multi-Destination' table with columns for ID, Enable, Type, Server Address, and Operation. The table contains two rows: ID 0 (Enabled, Milesight, localhost) and ID 1 (Disabled, ChirpStack-Generic, 192.168.23.183). A plus icon is located at the bottom right of the table.

2. Click  to add a new network server. "Milesight" type indicates the gateway network server.

The screenshot shows a dialog box for adding a new network server. It has a close button (X) in the top right corner. The 'Enable' checkbox is checked. The 'Type' dropdown menu is set to 'Semtech'. The 'Server Address' dropdown menu is set to 'router.eu.thethings.network'. The 'Port Up' and 'Port Down' input fields are both set to '1700'. A blue 'Save' button is located at the bottom center of the dialog.

3. Add the gateway on network server page. Take TTN for example, type and save the gateway EUI and other information when you connect it via Semtech packet forwarder. After you add the gateway, TTN will show connection status.

The screenshot shows the 'REGISTER GATEWAY' form in the Milesight IoT web interface. The form is titled 'REGISTER GATEWAY' and has a breadcrumb 'Gateways > Register'. It contains several sections: 'Gateway EUI' with a text input field containing '24 E1 24 FF FE 00 00 00 09' and a '8 bytes' indicator; a checked checkbox for 'I'm using the legacy packet forwarder' with a link to 'Semtech packet forwarder'; a 'Description' field with a text input field; and a 'Frequency Plan' dropdown menu set to 'Australia 915MHz'.

- Go to “Traffic” page to view the data communication of UG67.

General   Radios   Advanced   Custom <u>Traffic</u>								
Traffic Setting								
<input type="button" value="Stop"/> <input type="button" value="Clear"/>								
Rfch	Direction	Time	Ticks	Frequency	Datarate	Coderate	RSSI	SNR
0	up	05:57:30	212136749 3	903.9	SF10BW125	4/5	-51	13.2
0	up	05:57:29	211944923 1	904.5	SF7BW125	4/5	-95	8.5
0	up	05:57:13	210431205 7	904.6	SF8BW500	4/5	-51	11.5
0	up	05:57:06	209699855 6	903.9	SF7BW125	4/5	-65	14.2

## 4.2 Application Configuration

You can create a new application on this page, which is mainly used to define the method of decoding the data sent from end-device and choosing the data transport protocol to send data to another server address. The data will be sent to your custom server address using MQTT, HTTP or HTTPS protocol.

- Go to “Network Server” > “Application”.
- Click  to enter the configuration page, displayed as the following picture:

Status		General	<u>Applications</u>	Profiles	Device
Packet Forwarder		Applications			
Network Server		Name	<input type="text" value="cloud"/>		
Network		Description	<input type="text" value="cloud"/>		
		Payload Codec	<input type="text" value="None"/>		

- Click  to add a data transmission type of HTTP or HTTPS:  
Step 1: select HTTP or HTTPS as transmission protocol.

Type	<input type="text" value="HTTP"/>
------	-----------------------------------

- Step 2: Enter the header name and header value as needed.

HTTP Header

Header Name	Header Value	Operation
<input type="text"/>	<input type="text"/>	<input type="button" value="x"/>
		<input type="button" value="+"/>

Headers are name/value pairs that appear in both request and response messages. The name of the header is separated from the value by a single colon.

For example, this request message provides a header called User-Agent whose value is Mozilla/5.0 (Windows NT 6.3; WOW64; Trident/7.0; rv:11.0) like Gecko. The purpose of this particular header is to supply the web server with information about the type of browser making the request.

```
User-Agent: Mozilla/5.0 (Windows NT 6.3; WOW64; Trident/7.0; rv:11.0) like Gecko
```

Step 3: Enter the destination URL. Different types of data can be sent to different URLs.

URL

Data Type	URL
Uplink data	<input type="text"/>
Join notification	<input type="text"/>
ACK notification	<input type="text"/>
Error notification	<input type="text"/>

4. Click  to add a data transmission type of MQTT:

Step 1: select the transmission protocol as MQTT.

Type

Step 2: Fill in general settings.

General

Broker Address	<input type="text"/>
Broker Port	<input type="text"/>
Client ID	<input type="text"/>
Connection Timeout/s	<input type="text" value="30"/>
Keep Alive Interval/s	<input type="text" value="60"/>

Step 3: Select the authentication method required by the server.

If you select user credentials for authentication, you need to enter the username and password for authentication.

### User Credentials

Enable

Username

Password

If certificate is necessary for verification, please select mode and import CA certificate, client certificate and client key file for authentication.

### TLS

Enable

Mode

CA File

Client Certificate File

Client Key File

Step 4: Enter the topic to receive data and choose the QoS.

### Topic

Data Type	topic	
Uplink data	<input type="text"/>	<input type="text" value="QoS 0"/>
Join notification	<input type="text"/>	<input type="text" value="QoS 0"/>
ACK notification	<input type="text"/>	<input type="text" value="QoS 0"/>
Error notification	<input type="text"/>	<input type="text" value="QoS 0"/>

### 4.3 Device Configuration

Go to "Device" page and click "Add" to add LoRaWAN® node devices. Please select correct device profile according to device type.

General Applications Profiles **Device** Gateways Packets

**Device**

**Add** Bulk Import Delete All

Device Name	Device EUI	Device-Profile	Application	Last Seen	Activated	Operation
No matching records found						

Device Name:

Description:

Device EUI:

Device-Profile:

Application:

Modbus RTU Data Transmission:

Fport:

TCP Port:

Frame-counter Validation:

Application Key:

Device Address:

Network Session Key:

Application Session Key:

Uplink Frame-counter:

Downlink Frame-counter:

You can also click "Bulk Import" if you want to add many nodes all at once.

Import File  **Browse** **Import** **Template Download**

Click "Template Download" to download template file and add device information to this file. Application and device profile should be the same as you created on web page.

	A	B	C	D	E	F	G	H	I
1	name	description	deveui	application	deviceprofile	appkey	devaddr	appskey	nwkskey
2	24e1242191323266		24e1242191323266	cloud	ClassC-OTAA	112233445566778899aa112233445566			
3									
4									
5									

Import this file to add bulks of devices.

#### 4.4 Send Data to Device

Go to "Network Server" > "Packets".

Step 1: Please check the packet in the network server list to make sure that the device has joined the network successful.

1122612191	868100000	SF7BW125	-	-	17	0	JnAcc	2019-08-06T09:22:29+08:00	
112261219	868100000	SF7BW125	9.5	-77	18	0	JnReq	2019-08-06T09:22:29+08:00	

Step 2: Fill these input box.

**Send Data To Device**

Device EUI	Type	Payload	Fport	Confirmed
<input type="text" value="11226121913"/>	ASCII	<input type="text" value="15"/>	<input type="text" value="15"/>	<input checked="" type="checkbox"/>

Step 3: Click "Send".



Step 4: Check the packet in the network server list to make sure that the device has received this message successful. It's suggested to enable "Confirmed".

**Send Data To Device**

Device EUI	Type	Payload	Fport	Confirmed
<input type="text" value="11226121913"/>	ASCII	<input type="text" value="15"/>	<input type="text" value="15"/>	<input checked="" type="checkbox"/>

You can click "Refresh" to refresh the list or set automatic refreshing frequency for the list.  
**If the device's class type is Class C, then the device will be constantly receiving packet.**

This packet's type is DnCnf (Downlink Confirmed Packet) and if the packet's color is gray, then it means the packet cannot be transmitted now because at least one message has been in the queue.

11226121917	0	6	2	DnCnf	
-------------	---	---	---	-------	--

This is the data packet has been delivered successfully.

1122612191311123	869525000	SF12BW125	-	-	6	2	DnCnf	2019-08-06T09:22:55+08:00	Success
1122612191311123	0				6	2	DnCnf		Pending

If the device receives this downlink confirmed packet, then the device will reply "ACK" when delivering next.

Device EUI	Frequency	Datarate	SNR	RSSI	Size	Fcnt	Type	Time	Details
11226121913	868300000	SF10BW125	-	-	0	3	DnUnc	2019-08-06T09:23:44+08:00	
1122612191	868300000	SF10BW125	10.5	-75	64	2	UpCnf	2019-08-06T09:23:44+08:00	
112261219	869525000	SF12BW125	-	-	6	2	DnCnf	2019-08-06T09:22:55+08:00	
112261219	0				6	2	DnCnf		
112261219	868500000	SF10BW125	-	-	0	1	DnUnc	2019-08-06T09:22:49+08:00	

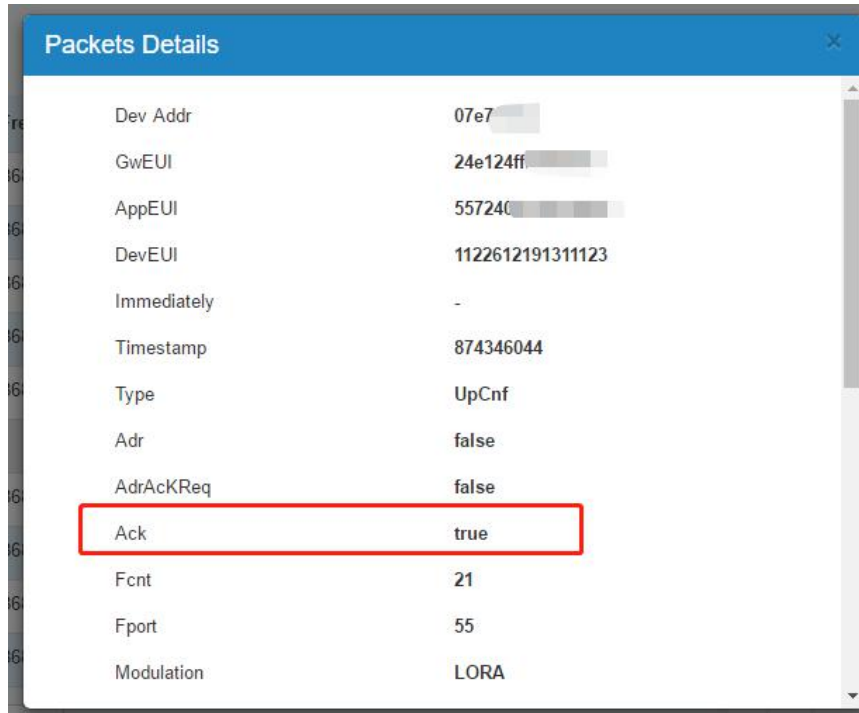

Ack is "true" means that the device has received this packet.

If the device's class type is Class A, Only after the device sends out an uplink packet will the network server sends out data to the device.

Network Server

Clear Search

Device EUI	Frequency	Datarate	SNR	RSSI	Size	Fcnt	Type	Time	Details
1122612191311123	868300000	SF10BW125	-	-	0	19	DnUnc	2019-08-06T09:49:38+08:00	!
1122612191311123	868300000	SF10BW125	10.8	-76	64	21	ACK	2019-08-06T09:49:38+08:00	!
1122612191311123	868300000	SF10BW125	10.8	-76	64	21	UpCnf	2019-08-06T09:49:38+08:00	!
1122612191311123	868100000	SF10BW125	-	-	6	18	DnCnf	2019-08-06T09:48:43+08:00	Success
1122612191311123	0				6	18	DnCnf	Pending	!
1122612191311123	868500000	SF10BW125	-	-	0	17	DnUnc	2019-08-06T09:47:38+08:00	!
1122612191311123	868500000	SF10BW125	8.0	-76	64	19	UpCnf	2019-08-06T09:47:38+08:00	!
1122612191311123	868100000	SF10BW125	-	-	0	16	DnUnc	2019-08-06T09:46:38+08:00	!
1122612191311123	868100000	SF10BW125	11.2	-74	64	18	UpCnf	2019-08-06T09:46:37+08:00	!

Manual Refresh Refresh

Show the signal-noise ratio.

**RSSI**  
Show the received signal strength indicator.

**Size**  
Show the size of packet.

**Fcnt**  
Show the frame counter.

**Type**  
Show the type of the packet:  
 JnAcc - Join Accept Packet  
 JnReq - Join Request Packet  
 UpUnc - Uplink Unconfirmed Packet  
 UpCnf - Uplink Confirmed Packet - ACK response from network requested  
 DnUnc - Downlink Unconfirmed Packet  
 DnCnf - Downlink Confirmed Packet  
 Packet - ACK response from end-device requested

**Time**  
Show the time of packet was sent



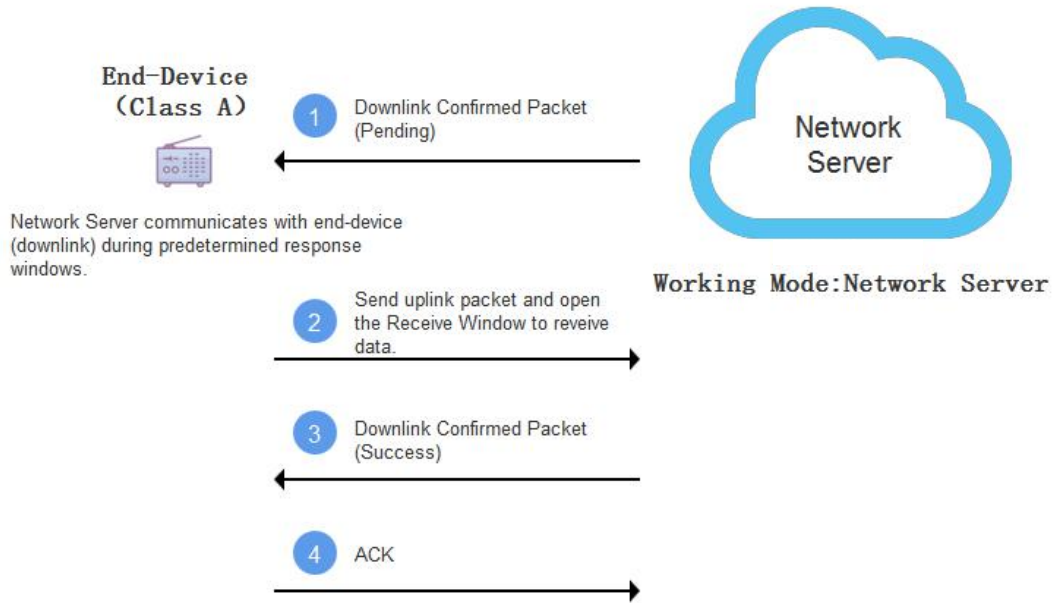

Network Server

Clear Search

Device EUI	Frequency	Datarate	SNR	RSSI	Size	Fcnt	Type	Time	Details
1122612191311123	868300000	SF10BW125	-	-	0	19	DnUnc	2019-08-06T09:49:38+08:00	!
1122612191311123	868300000	SF10BW125	10.8	-76	64	21	ACK	2019-08-06T09:49:38+08:00	!
1122612191311123	868300000	SF10BW125	10.8	-76	64	20	UpCnf	2019-08-06T09:49:38+08:00	!
1122612191311123	868100000	SF10BW125	-	-	6	18	DnCnf	2019-08-06T09:48:43+08:00	!
1122612191311123	868100000	SF10BW125	9.8	-77	64	20	UpCnf	2019-08-06T09:48:43+08:00	!
1122612191311123	0				6	18	DnCnf		!
1122612191311123	868500000	SF10BW125	-	-	0	17	DnUnc	2019-08-06T09:47:38+08:00	!
1122612191311123	868500000	SF10BW125	8.0	-76	64	19	UpCnf	2019-08-06T09:47:38+08:00	!
1122612191311123	868100000	SF10BW125	-	-	0	16	DnUnc	2019-08-06T09:46:38+08:00	!
1122612191311123	868100000	SF10BW125	11.2	-74	64	18	UpCnf	2019-08-06T09:46:37+08:00	!

Showing 51 to 60 of 355 rows  rows per page Manual Refresh Refresh

*means the device has received the packet you send.*

## Related Topic

[Packets](#)

## 4.5 Restore Factory Defaults

### 4.5.1 Via Web Interface

1. Log in web interface, and go to "Maintenance > Backup and Restore".
2. Click "Reset" button under the "Restore Factory Defaults".

You will be asked to confirm if you'd like to reset it to factory defaults. Then click "Reset" button.

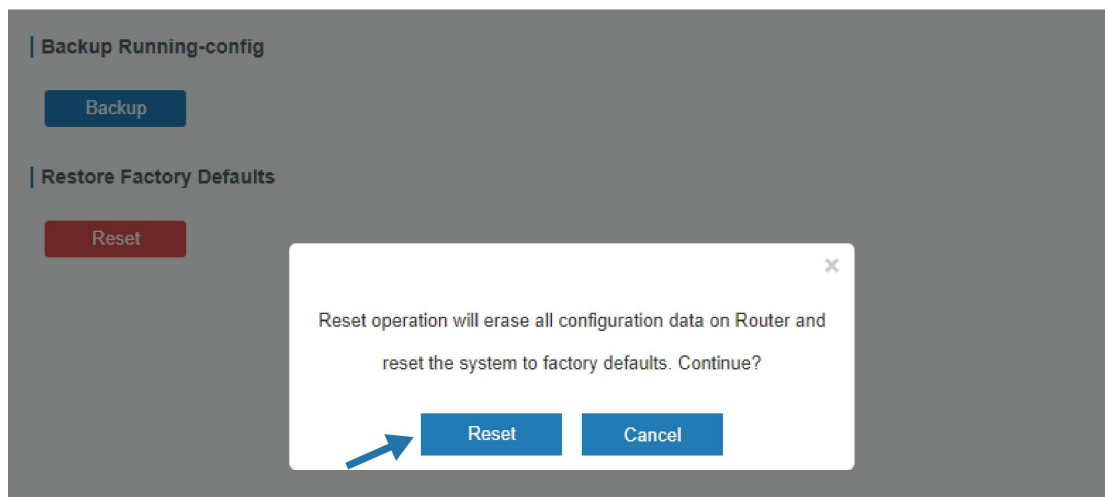
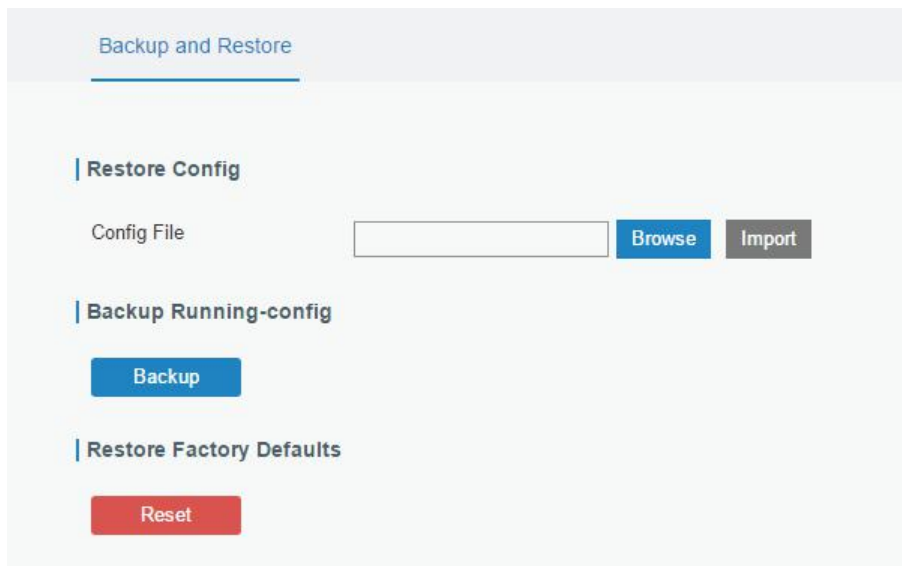

Then the gateway will reboot and restore to factory settings immediately.

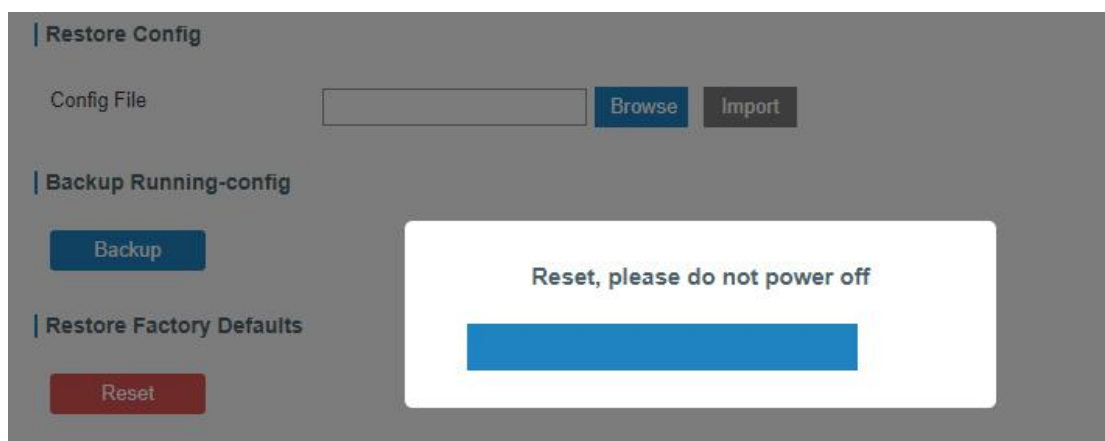

Please wait till STATUS light staticly and the login page pops up again, which means the gateway has already been reset to factory defaults successfully.

### Related Topic

[Restore Factory Defaults](#)

### 4.5.2 Via Hardware

Locate the reset button on the gateway, and take corresponding actions based on the status of SYS LED.

SYS LED	Action
Blinking	Press and hold the reset button for more than 5 seconds.
Static Green → Rapidly Blinking	Release the button and wait.
Off → Static Green	The gateway is now reset to factory defaults.

### 4.6 Firmware Upgrade

It is suggested that you contact Milesight technical support first before you upgrade gateway firmware. Gateway firmware file suffix is “.bin”.

After getting firmware file please refer to the following steps to complete the upgrade.

1. Go to “Maintenance > Upgrade”.
2. Click “Browse” and select the correct firmware file from the PC.
3. Click “Upgrade” and the gateway will check if the firmware file is correct. If it’s correct, the firmware will be imported to the gateway, and then the gateway will start to upgrade.

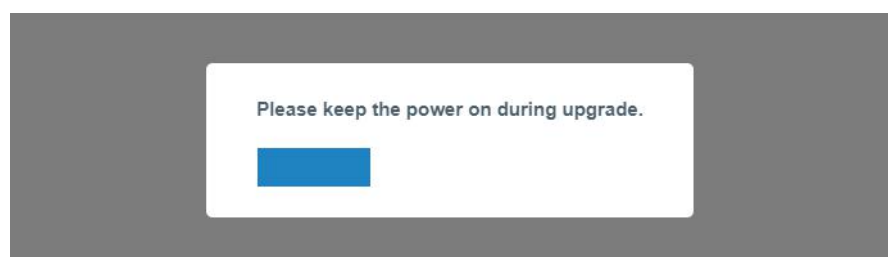

#### Related Topic

[Upgrade](#)

## 4.7 Cellular Connection

1. Go to “Network > Interface > Cellular > Cellular Setting” and configure the cellular info.
2. Choose relevant network type.

Port	WLAN	Cellular	Loopback
<b>Cellular Setting</b>			
Enable		<input checked="" type="checkbox"/>	
Network Type		Auto	
APN			
Username			
Password			
Access Number			
PIN Code			
Authentication Type		Auto	
Roaming		<input checked="" type="checkbox"/>	
SMS Center			
Connection Setting		<input type="checkbox"/>	
Enable NAT		<input checked="" type="checkbox"/>	

Click “Save” and “Apply” for configuration to take effect.

3. Check the cellular connection status by WEB GUI of gateway.

Click “Status > Cellular” to view the status of the cellular connection. If it shows 'Connected', SIM has dialed up successfully.

Overview	Packet Forward	Cellular	Network	WLAN
<b>Modem</b>				
Status		Ready		
Model		EC25		
Version		EC25ECGAR06A07M1G		
Signal Level		23asu (-67dBm)		
Register Status		Registered (Home network)		
IMEI		860425047368939		
IMSI		460019425301842		
ICCID		89860117838009934120		
ISP		CHN-UNICOM		
Network Type		LTE		
PLMN ID				
LAC		5922		
Cell ID		340db83		
<b>Network</b>				
Status		Connected		
IP Address		10.132.132.59		
Netmask		255.255.255.240		
Gateway		10.132.132.60		

4. Check out if network works properly by browser on PC.

Open your preferred browser on PC, type any available web address into address bar and see if it is able to visit Internet via the UG67.

### Related Topic

[Cellular Setting](#)

[Cellular Status](#)

## 4.8 Wi-Fi Application Example

### 4.8.1 AP Mode

#### Application Example

Configure UG67 as AP to allow connection from users or devices.

#### Configuration Steps

1. Go to "Network > Interface > WLAN" to configure wireless parameters as below.

Port	WLAN	Cellular	Loopback
<b>WLAN</b>			
Enable	<input checked="" type="checkbox"/>		
Work Mode	AP		
SSID Broadcast	<input checked="" type="checkbox"/>		
AP Isolation	<input type="checkbox"/>		
Radio Type	802.11n(2.4GHz)		
Channel	Auto		
SSID	Gateway_F1200F		
BSSID	24:e1:24:f1:20:0f		
Encryption Mode	No Encryption		
Bandwidth	20MHz		
Max Client Number	10		

Click "Save" and "Apply" buttons after all configurations are done.

2. Use a smart phone to connect the access point of gateway. Go to "Status > WLAN", and

you can check the AP settings and information of the connected client/user.

Overview	Packet Forward	Cellular	Network	<u>WLAN</u>	VPN
<b>WLAN Status</b>					
Wireless Status	Enabled				
MAC Address	24:e1:24:f1:20:0f				
Interface Type	AP				
SSID	Gateway_F1200F				
Channel	Auto				
Encryption Type	No Encryption				
Status	Up				
IP Address	192.168.1.1				
Netmask	255.255.255.0				
Connection Duration	0 days, 02:40:52				

## 4.8.2 Client Mode

### Application Example

Configure UG67 as Wi-Fi client to connect to an access point to have Internet access.

### Configuration Steps

1. Go to "Network > Interface > WLAN" and click "Scan" to search for WiFi access point.

Port	<u>WLAN</u>	Cellular	Loopback				
<a href="#">&lt; GoBack</a>							
SSID	Channel	Signal	Cipher	BSSID	Security	Frequency	
AAA	Auto	-61dBm	AES	24:e1:24:f0:c4:13	WPA-PSK/WPA2-PSK	2412MHz	<a href="#">Join Network</a>

2. Select one access point and click "Join Network", then type the password of the access point.

Port	WLAN	Cellular	Loopback
<b>WLAN</b>			
Enable	<input checked="" type="checkbox"/>		
Work Mode	Client		Scan
SSID	AAA		
BSSID	24:e1:24:f0:c4:13		
Encryption Mode	WPA-PSK/WPA2-PSK		
Cipher	AES		
Key	.....		
<b>IP Setting</b>			
Protocol	DHCP Client		

Click “Save” and “Apply” buttons after all configurations are done.

3. Go to “Status > WLAN”, and you can check the connection status of the client.

Overview	Packet Forward	Cellular	Network	WLAN
<b>WLAN Status</b>				
Wireless Status		Enabled		
MAC Address		24:e1:24:f0:de:14		
Interface Type		Client		
SSID		AAA		
Channel		Auto		
Encryption Type		WPA-PSK/WPA2-PSK		
Cipher		AES		
Status		Connected		
IP Address		192.168.1.145		
Netmask		255.255.255.0		
Connection Duration		0 days, 02:44:45		

## Related Topic

[WLAN Setting](#)

[WLAN Status](#)

**[END]**