

GW-7557 PROFIBUS/HART Gateway

User's Manual



High Quality, Industrial Data Acquisition, and Control Products

Warranty

All products manufactured by ICP DAS are under warranty regarding defective materials for a period of one year from the date of delivery to the original purchaser.

Warning

ICP DAS assumes no liability for damages resulting from the use of this product. ICP DAS reserves the right to change this manual at any time without notice. The information furnished by ICP DAS is believed to be accurate and reliable. However, no responsibility is assumed by ICP DAS for its use, or for any infringements of patents or other right of third parties resulting from its use.

Copyright

Copyright 2011 by ICP DAS. All rights are reserved.

Trademark

The names used for identification only may be registered trademarks of their respective companies.

List of Revision

Date	Author	Version	Revision
2012/03/30	Ryan	1.10	Release

Table of Contents

1. Introduction	4
1.1 Features	5
1.2 Specification	5
2. Hardware	7
2.1 Block Diagram of GW-7557	7
2.2 Pin Assignment	7
2.3 Wiring	9
2.4 Setting the PROFIBUS Address	13
2.5 LED status indicator	15
2.6 Normal/Setting DIP switch	16
2.7 Jumper	17
3.1 PROFIBUS data exchange	18
3.2 HART data exchange	19
3.3 Communication protocol transfer	20
4. Communication	23
4.1 Field of application	23
4.2 GSD file	24
4.3 The Configuration of the common parameters	26
4.4 The Configuration of the modules	28
4.5 Diagnostic messages	30
4.6 I/O data exchange	32
4.7 Establish connection with GW-7557	34
4.8 Data exchange example — Transparent format	36
4.9 Data exchange example — Compact format	44
5. Application of Utility	55
5.1 Install Utility	55
5.2 Utility introduction	58
5.3 Establish connection with GW-7557	69
6. Troubleshooting	72
7. Dimensions	73
Appendix A. HART Command	75

1. Introduction

PROFIBUS and HART are two kinds of famous protocols and are widely used in the fields of factory and process automation. The GW-7557 is a PROFIBUS to HART gateway. By using this module, users can easily put the HART slave devices into PROFIBUS network. *Figure 1* shows an application example for the GW-7557 module.

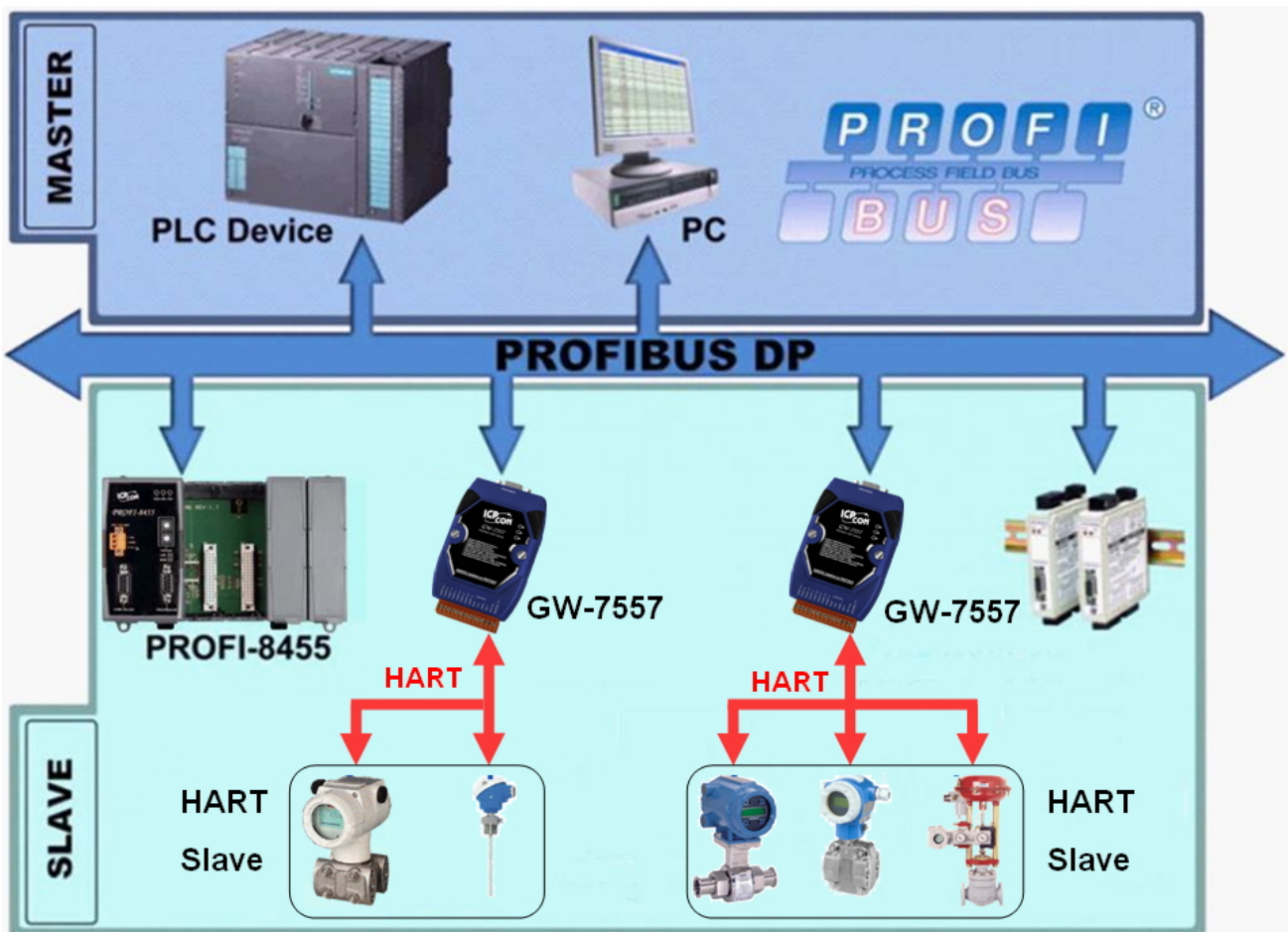

Figure 1 Application architecture of the GW-7557 module

The GW-7557 gateway is specially designed for the slave device of PROFIBUS DP protocol. In the HART application, the GW-7557 can be a HART master device. The HART slave devices can exchange data with the PROFIBUS master device via the GW-7557 module.

The main features and specification of GW-7557 are described as below:

1.1 Features

- 16-bit Microprocessor inside with 80MHz
- Profichip VPC3+C PROFIBUS controller
- Support PROFIBUS DP-V0 slave
- PROFIBUS transmission rate detect automatically
- Max transmission speed up to 12 Mbps for PROFIBUS and 115.2 kbps for COM Port
- COM Port driver has 1K bytes QUEUE input buffer & 512 bytes QUEUE output buffer
- Allow two HART masters
- Working in point-to-point or multi-drop HART mode
- Support 4 HART channels
- Connecting up to 15 HART slave devices per HART channel
- Support HART Short/Long frame
- Support HART burst mode
- 2500Vrms High Speed iCoupler Isolation Protection for PROFIBUS network
- 3000V_{DC} Isolation Protection on the PROFIBUS side
- Provide LED indicators
- Built-in Watchdog
- Mountable on DIN Rail

1.2 Specification

COM Port specs:

- Serial port - RS-232
- Serial port interface: screw terminal block
- Baud Rate : 2400/4800/9600/19200/38400/57600/115200 bps
- Data Format: 7/8 data bits, None/Odd/Even parity bit, 1/2 stop bit

PROFIBUS specs:

- PROFIBUS interface connector: D-Sub 9-pin female
- Baud Rate: 9.6k/19.2k/45.45k/93.75k/187.5k/500k/1.5M/3M/6M/12Mbps
- Address Setting: 0~126 (set by DIP switch or EEPROM)

HART specs:

- 4 HART channels
- HART port interface: screw terminal block
- Working in point-to-point or multi-drop HART mode
- Connecting up to 15 HART slave devices per HART channel
- Support HART Short/Long frame
- Support HART burst mode

- Allow two HART masters

Power requirement:

- Unregulated +10 ~ +30 V_{DC}
- Power reverse protection, Over-Voltage brown-out protection
- Power consumption 2.0W

Module specs:

- Dimensions: 119mm x 72mm x 33mm
- Operating temperature: -25 ~ 75 °C
- Storage temperature: -30 ~ 85 °C
- Humidity : 5 ~ 95% RH, non-condensing
- LED Status Indicators(*Table 1*)

Table 1: *LED status indicator*

PWR LED	– Show the power state – Show data state
ERR LED	– Show error state
RUN LED	– Show communication state of PROFIBUS

2. Hardware

2.1 Block Diagram of GW-7557

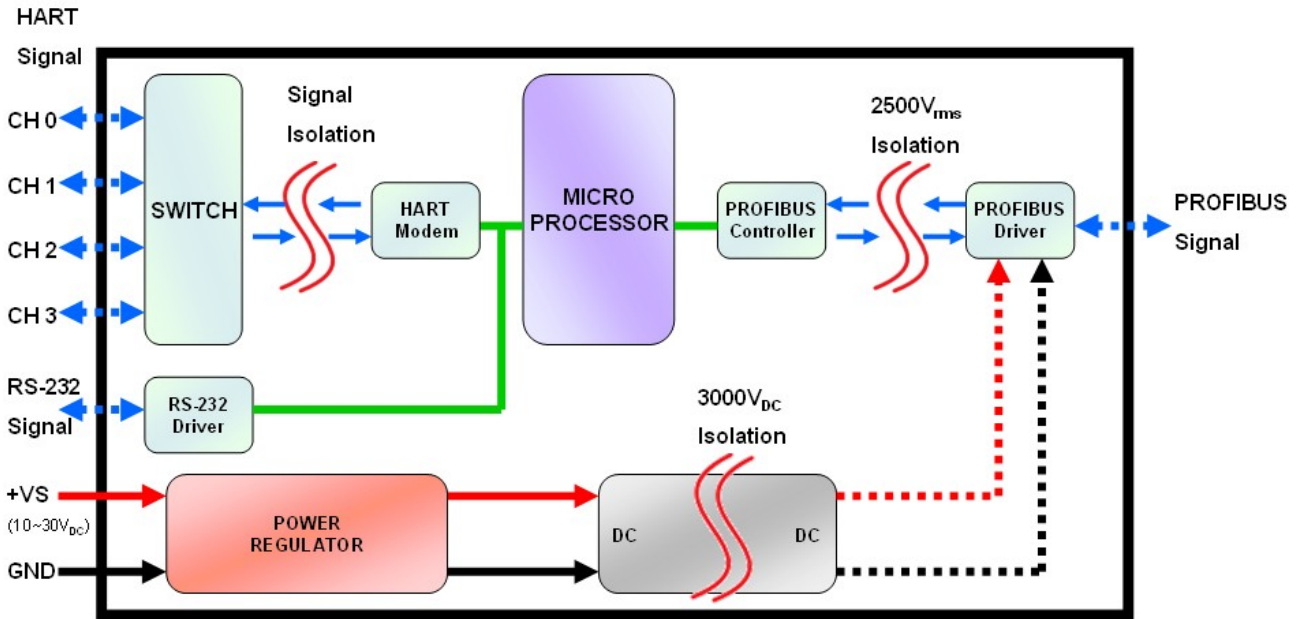

Figure 2 Block diagram of GW-7557

2.2 Pin Assignment

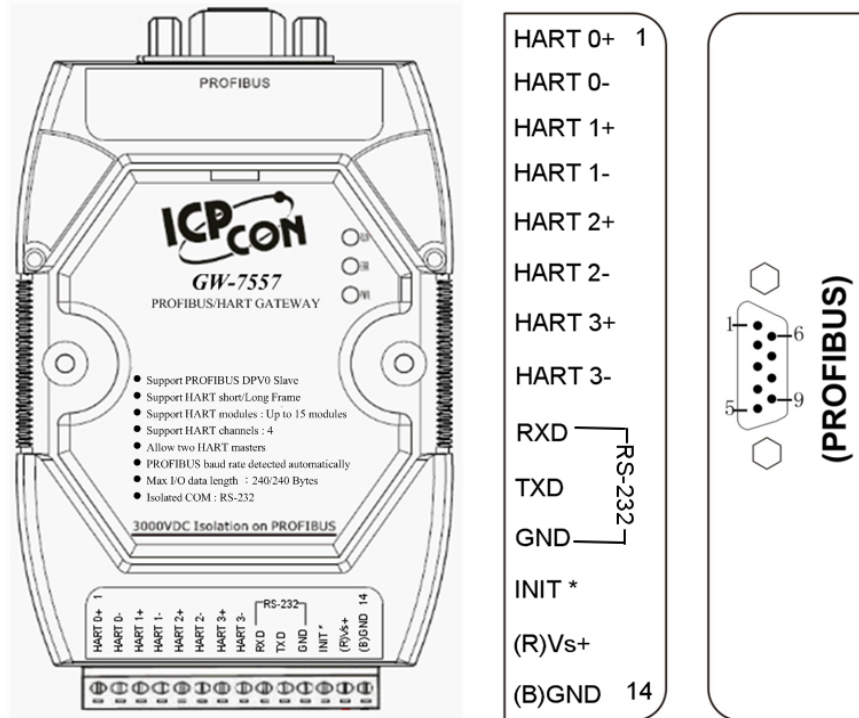

Figure 3 Pin assignment of GW-7557

Table 2 14-pin screw terminal block

Pin	Name	Description
1	HART 0+	Positive of HART channel 0
2	HART 0-	Negative of HART channel 0
3	HART 1+	Positive of HART channel 1
4	HART 1-	Negative of HART channel 1
5	HART 2+	Positive of HART channel 2
6	HART 2-	Negative of HART channel 2
7	HART 3+	Positive of HART channel 3
8	HART 3-	Negative of HART channel 3
9	RX	Receive Data of RS-232
10	TX	Transmit Data of RS-232
11	GND	GND of RS-232
12	INIT*	Initial Pin
13	+VS	V+ of Power Supply(+10 ~ +30 VDC)
14	GND	GND of Power Supply

Table 3 PROFIBUS DB9 Female Connector

Pin	Name	Description
1	-	N/A
2	-	N/A
3	B	Non-inverting Bus Line
4	ISODE	Isolated DE output for use in PROFIBUS applications where the state of the isolated drive enable node needs to be monitored.
5	GND	Power supply ground for the first node and the last node
6	VP	+5V Power Supply for the first node and the last node
7	-	N/A
8	A	Inverting Bus Line
9	-	N/A

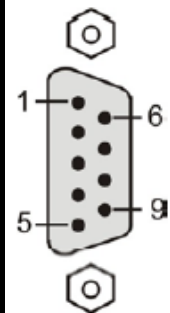

2.3 Wiring

GW-7557 supports PROFIBUS to HART communication. The following section describes the connection interface of GW-7557.

2.3.1 RS-232 connection

The RS-232 port of the GW-7557 has got three pins. The wiring of the RS-232 device with the RS-232 port of the GW-7557 is shown in *Figure 4*.

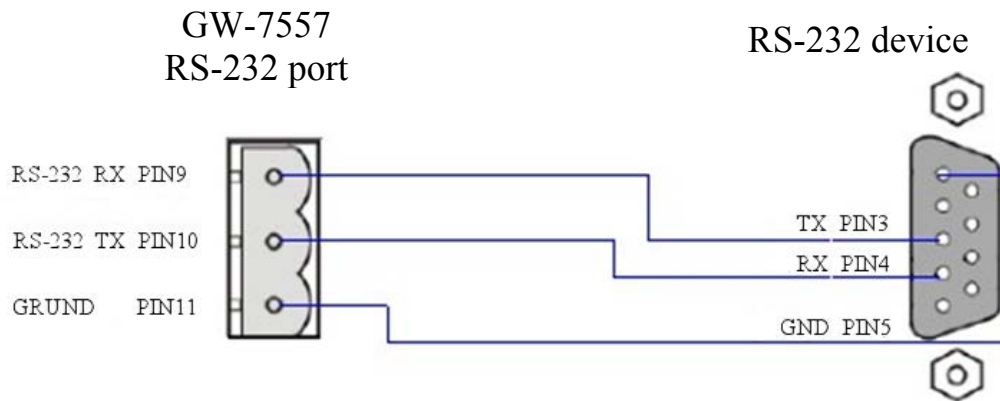

Figure 4 RS-232 wiring diagram

2.3.2 PROFIBUS connection

The PROFIBUS interface of the GW-7557 is a DB9 female connector. The connector uses the standard PROFIBUS 9 pin assignment. It is recommended to use a standard PROFIBUS cable and connector (DB9 male). As with every serial bus the rate of safe data transmission in a PROFIBUS network decreases with increasing distance between Master and Slave. *Table 4* shows the transmission rate and range for a cable with the following properties:

1. Impedance :135~165 Ω
2. Capacity : lower than 30 pF/m
3. Loop resistance : lower than 110 Ω /km
4. Wire diameter : greater than 0.65 mm
5. Core cross-section : greater than 0.34 mm²

Table 4 Transmission rate decreasing with increasing transmission distance

Transmission Rate(kbps)	Transmission Distance per Segment (meter)
9.6, 19.2, 45.45, 93.75	1200
187.5	1000
500	400
1500	200
3000, 6000, 12000	100

In order to minimize the reflection effect of signal transmission, both ends (first node and last node) of a PROFIBUS segment needs to be equipped with an active terminal resistor as shown in *Figure 5*. A standard PROFIBUS connector is usually already equipped with a terminal resistor. The user therefore only has to switch on the resistor of the devices stationed at the ends of a segment as shown in *Figure 6*.

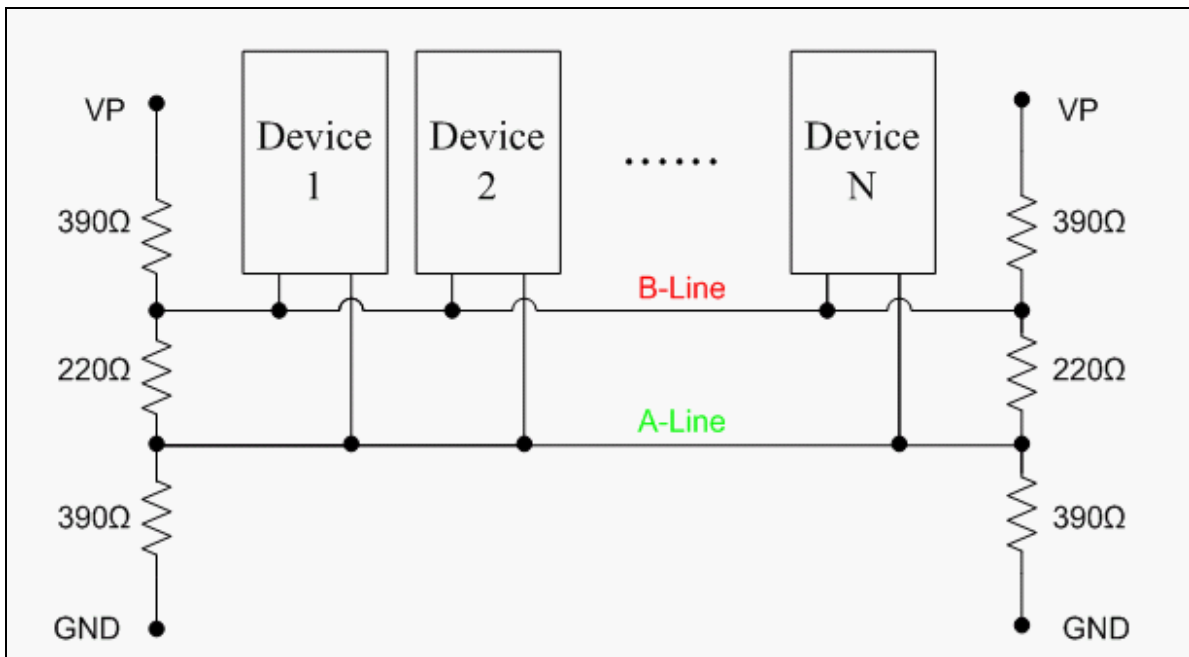

Figure 5 PROFIBUS connection

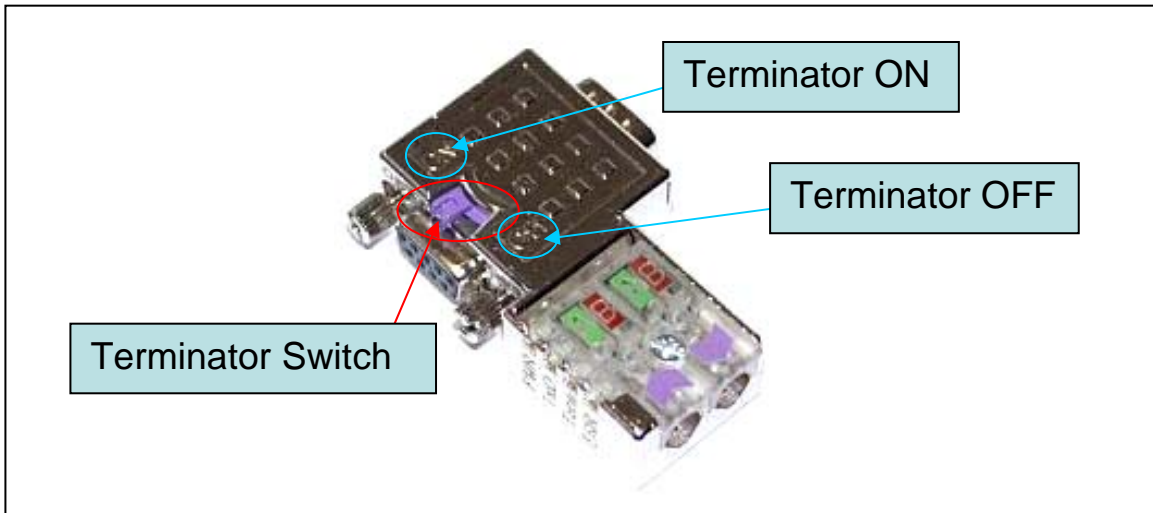

Figure 6 PROFIBUS connector

The number of stations in a PROFIBUS network is restricted to 126. According to the PROFIBUS specification up to 32 stations are allowed per segment. A repeater has to be used to link the bus segments.

2.3.3 HART connection

The HART connection is divided into two types: “Loop Power Source” and “External Power Source”, as shown in the below:

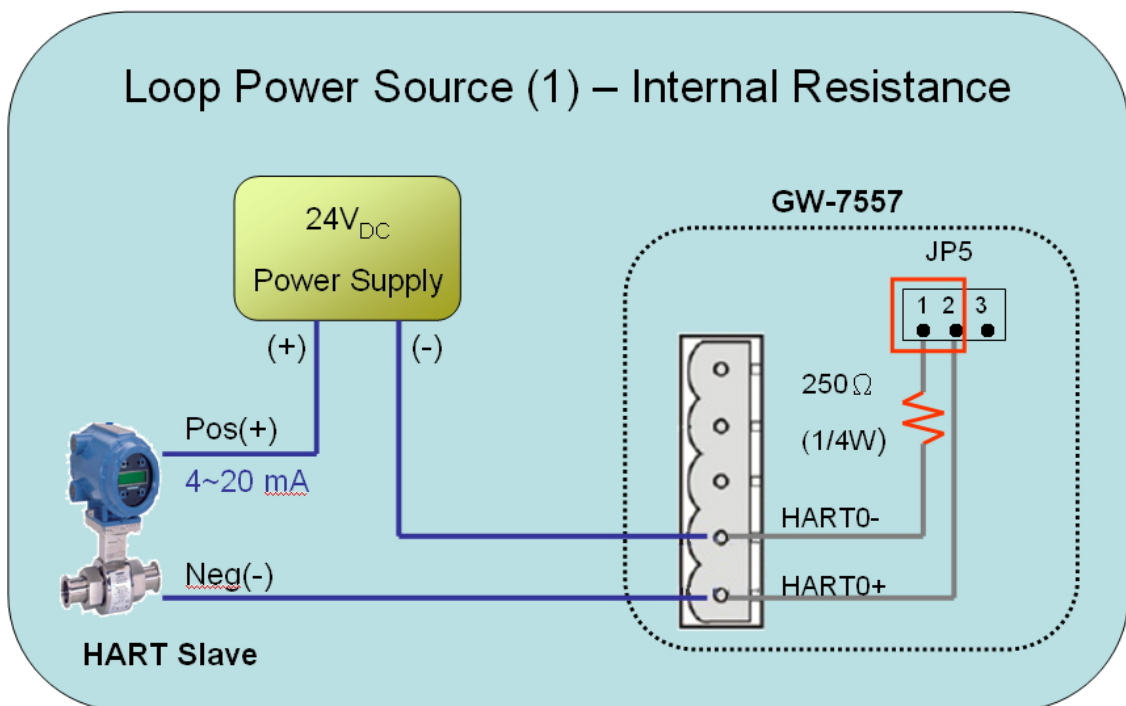

Figure 7 Loop Power Source (1)

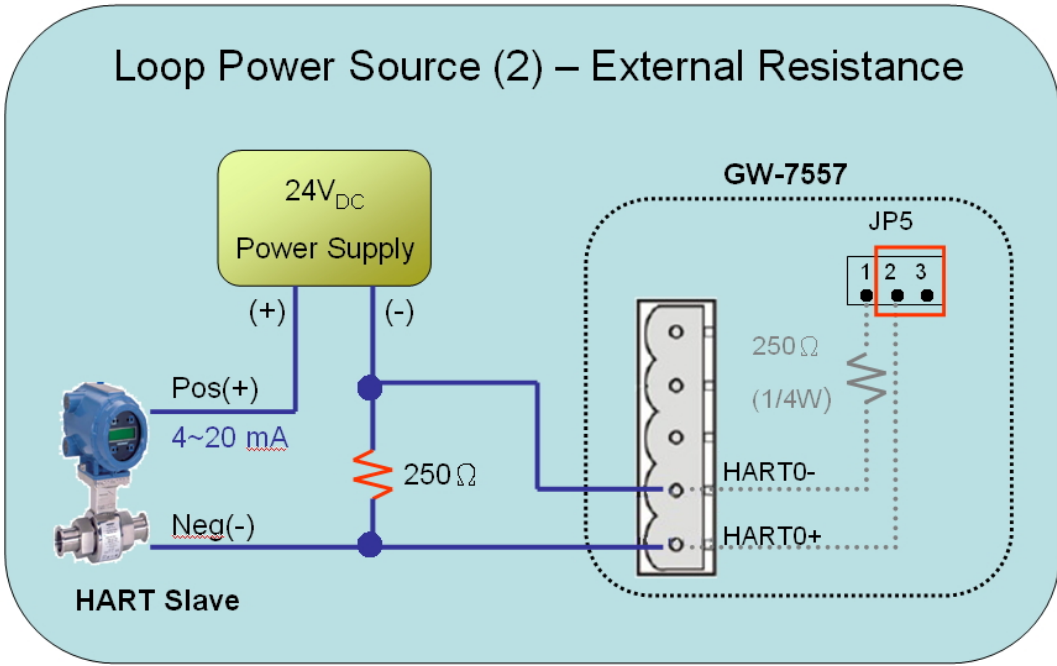

Figure 8 Loop Power Source (2)

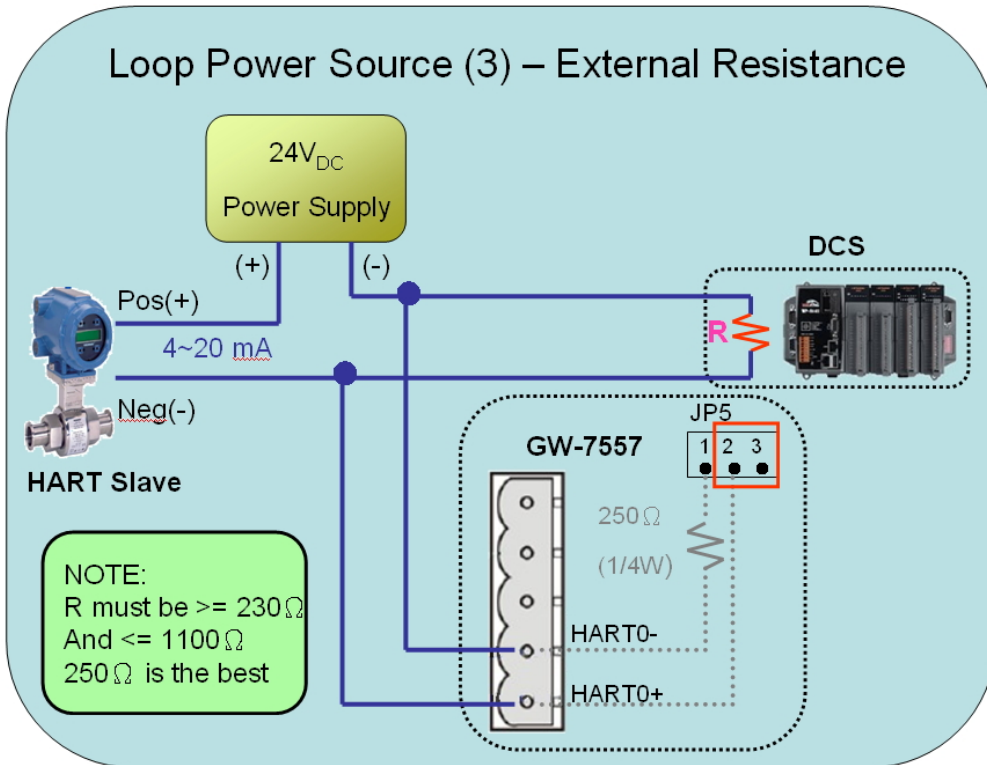

Figure 9 Loop Power Source (3)

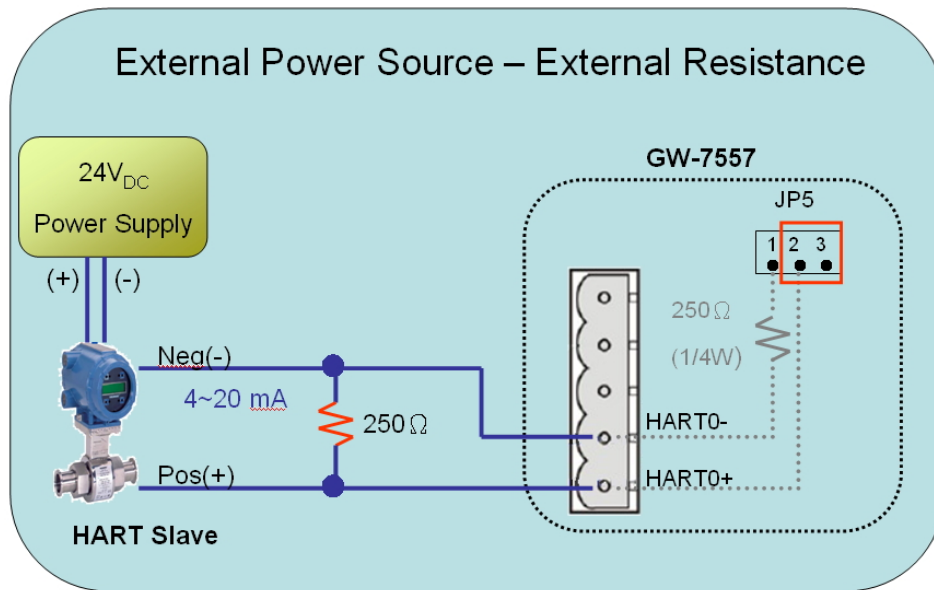

Figure 10 External Power Source

2.4 Setting the PROFIBUS Address

The station address of GW-7557 can be set by using the DIP switch or by writing it directly to the EEPROM. The DIP switch covers a range from 0 to 255. The valid address range of a PROFIBUS station spans from 0 to 126. *Table 5* shows three examples of setting the station address by using the DIP switch. The DIP switches are accessed by opening the modules housing (*Figure 11*). *Table 6* explains which address will be used by the module after power on, if the DIP switch address setting differs from the address stored in the EEPROM.

Table 5 DIP switch setting example

Station address	DIP switch (SW1)							
	1	2	3	4	5	6	7	8
1	1	0	0	0	0	0	0	0
10	0	1	0	1	0	0	0	0
126	0	1	1	1	1	1	1	0

Note: 1=>ON, 0=>OFF

Table 6 The Address setting of the GW-7557

DIP switch Setting	Description
0~125	<ol style="list-style-type: none"> 1. The address setting of the EEPROM is ignored. 2. The address can not be set by the PROFIBUS configuration tool.
126-254	<ol style="list-style-type: none"> 1. The address setting of the DIP switch is ignored. 2. If the address in the EEPROM is 126, the PROFIBUS configuration tool can set a new address and save it to the EEPROM.
255	<ol style="list-style-type: none"> 1. Slave address in the EEPROM is set to 126.

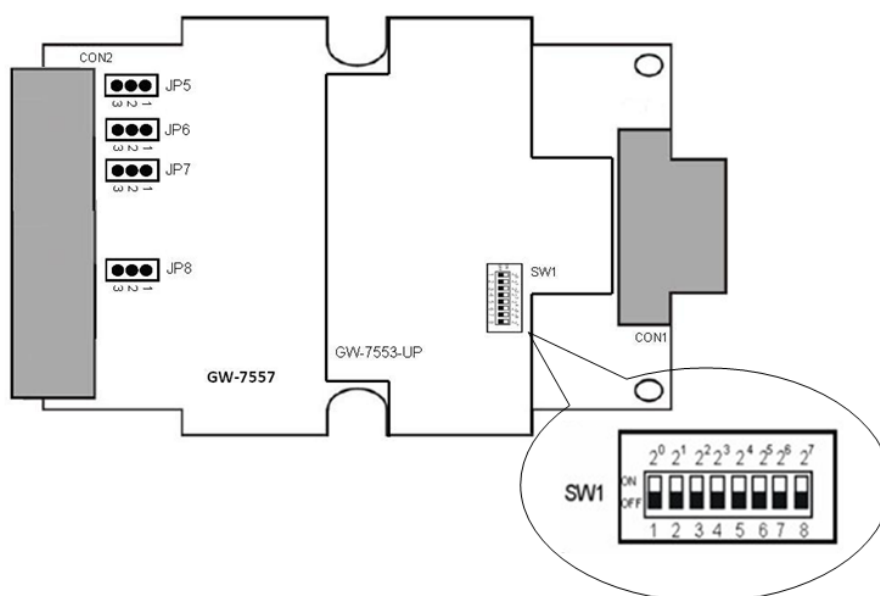

Figure 11 DIP switch

Each Slave must have a unique valid address (1 to 125) in order to be able to communicate with the master. To change the address by using the configuration tool it is necessary to first set the address that stored in the EEPROM to 126. This is done by setting the DIP switch to 255 in the power off state. Switching the module on is forcing the module to change its address that stored in the EEPROM to 126. In the next step switch the module off and change the DIP switch setting to any value from 126 to 254. This step is necessary in order to prevent the module to change its address that stored in the EEPROM to 126 every time. The configuration tool can assign a new address to slave now.

2.5 LED status indicator

The GW-7557 provides three LEDs to indicate the statuses of the GW-7557 module. The position of LEDs and descriptions are shown in *Table 7* and *Figure 12*.

Table 7 LED status description

LED Name	Status	Description
PWR	flash	Power supply is ok. HART port is transmitting or receiving HART frame.
	on	Power supply is ok. The firmware has loaded.
	off	Power supply has failed.
ERR	flash	When the GW-7557 connects with the utility tool, it will flash fast (flash once about 55ms). When the GW-7557 has diagnostic message, it will flash slowly (flash once about 220ms).
	on	<ul style="list-style-type: none"> – Connection error between PROFIBUS Master and Slave or – PROFIBUS system has not been configured correctly.
	off	Normal operation PROFIBUS system has been configured correctly
RUN	on	Data exchange mode Normal operation.
	off	GW-7557 module is not in a data exchange mode.



Figure 12 LED position

2.6 Normal/Setting DIP switch

There is a DIP switch on the back of the GW-7557 module, as shown in *Figure 13*. The DIP switch is used to set the communication settings of COM port. In the normal situation, it needs to set the DIP switch to the “Normal” position. If the user forgets the communication settings of COM port. The user can set the DIP switch to the “Setting” position, the communication settings of COM port will be started at default settings.

PS:

About default settings are shown in the below:

Baudrate : 115200 bps

Data bit : 8 bits

Stop bit : 1 bit

Parity : None

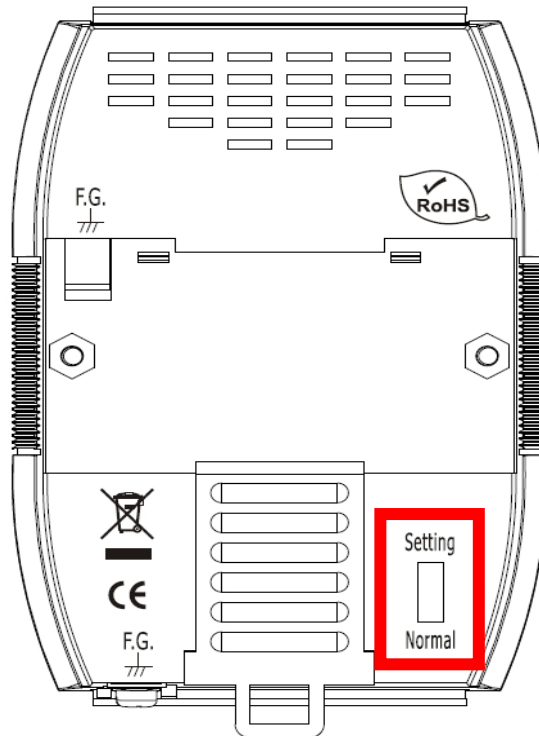

Figure 13 DIP switch of the GW-7557

2.7 Jumper

There are four Jumpers (JP5~JP8) at the GW-7557 module, as shown in *Figure 14*. These jumper can provide HART channel with 250 Ω (1/4 W) resistor. When the pin 1&2 of JP5 is closed, the resistor will connect to HART channel 0. When the pin 2&3 of JP5 is closed, it will disconnect the resistor from HART channel 0. By default, the pin1&2 of JP5 is closed. Please refer to section 2.3.3 HART connection for detail.

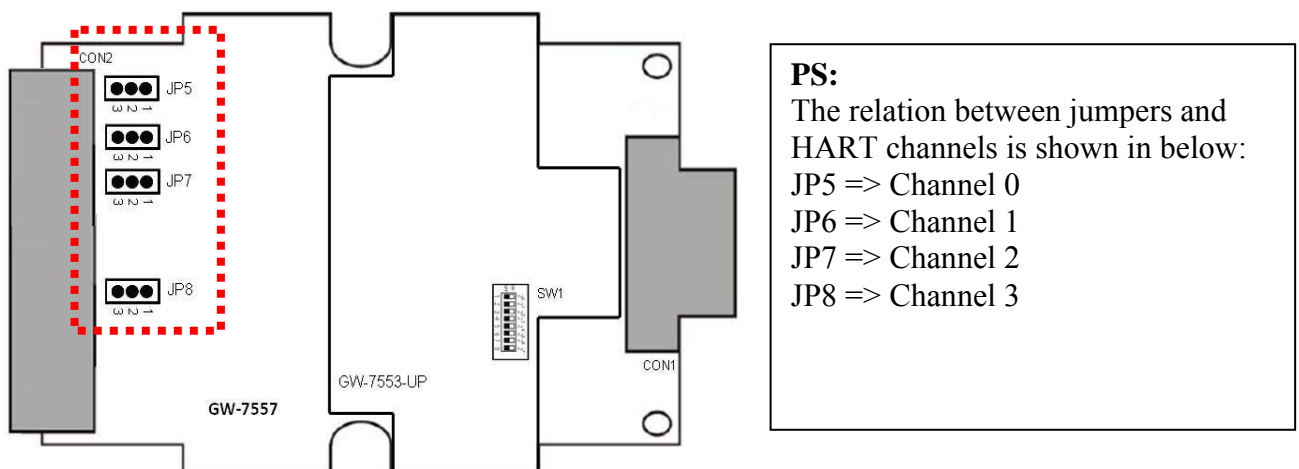

Figure 14 Jumpers of GW-7557

3. Communication protocol transfer theorem

3.1 PROFIBUS data exchange

The GW-7557 is a PROFIBUS DP slave device. The GW-7557 is first parameterized then configured and finally it goes into the data exchange mode (Figure 15).

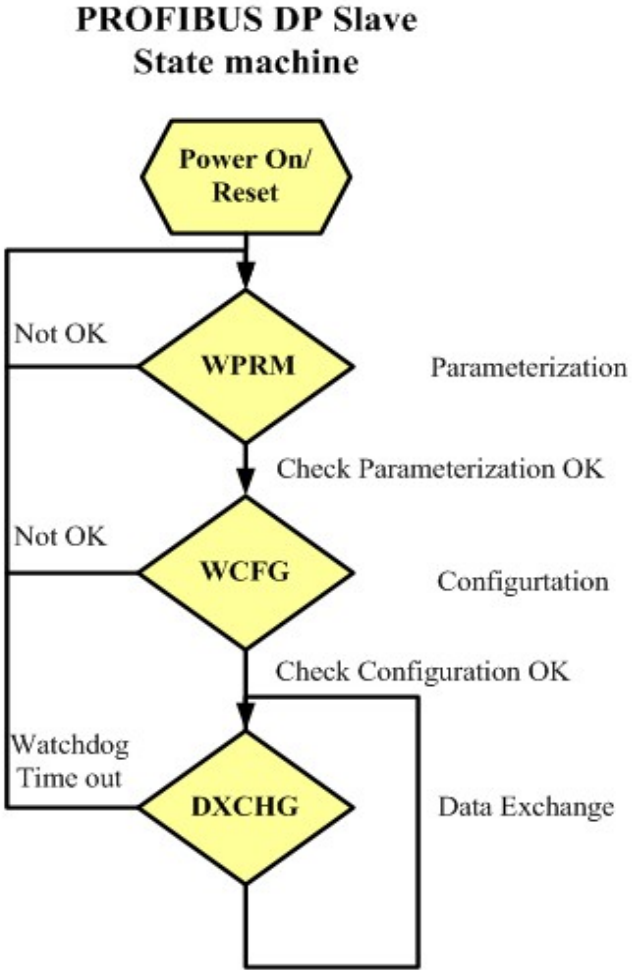

Figure 15 State machine of PROFIBUS DP Slave device

The GW-7557 exchanges data cyclically between internal Output Queue · Input Queue and PROFIBUS Master device in data exchange mode, as shown in Figure 16.

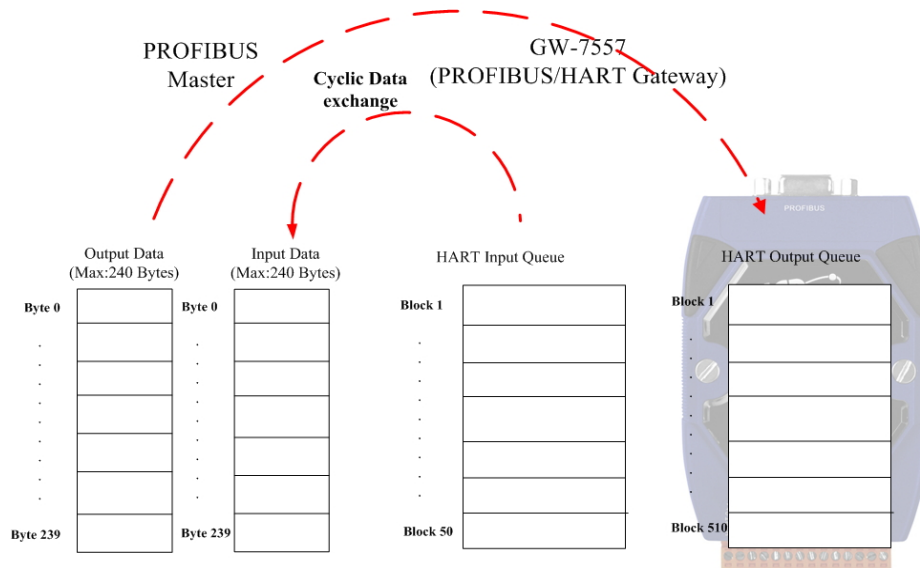

Figure 16 Data exchange between PROFIBUS master device and GW-7557

The GW-7557 downloads the parameter and configuration from PROFIBUS master device to be the module parameters. The GW-7557 and PROFIBUS master device have different data type and data address, the GW-7557 can transfer different data format to PROFIBUS master device through module parameters.

3.2 HART data exchange

HART protocol belongs to Master-Slave communication and it uses query and response message to arrive at data exchange and device control, as shown in *Figure 17*.

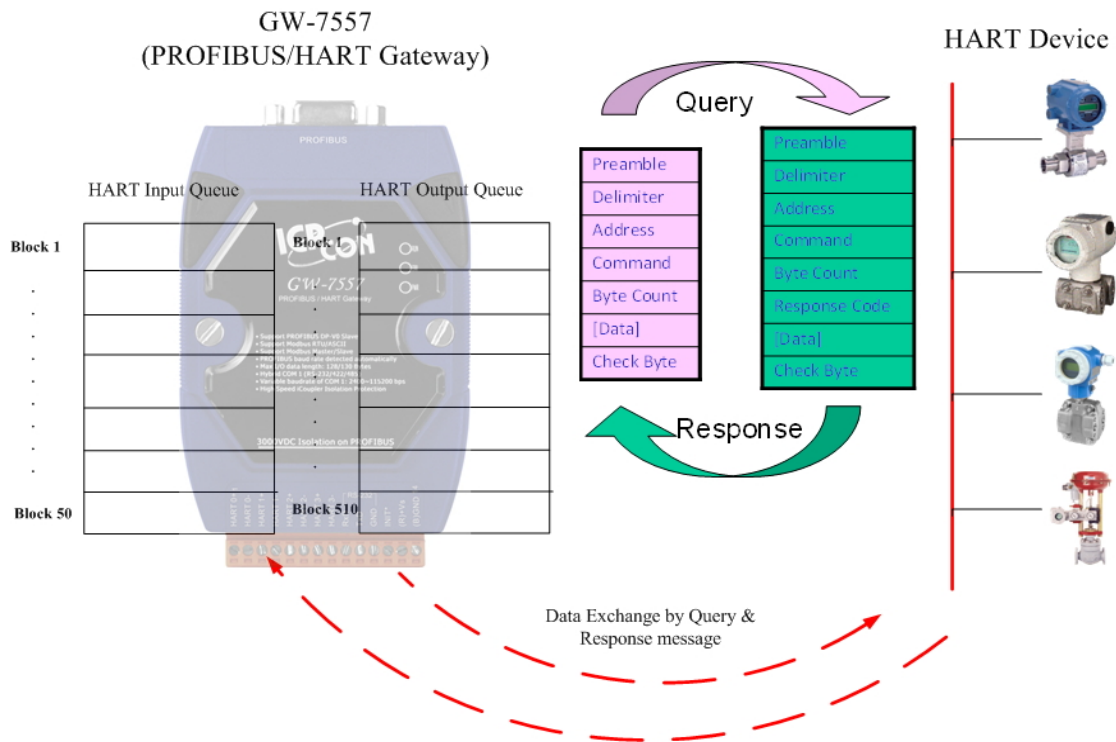

Figure 17 Data exchange between the HART slave devices and the GW-7557

3.3 Communication protocol transfer

In section 3.1 and 3.2, we can understand that data exchange is through Output Queue、Input Queue of the GW-7557 between PROFIBUS Master、HART slave devices and the GW-7557. The data exchange runs continuously between PROFIBUS master、HART slave device and the GW-7557, as shown in Figure 18 and Figure 19

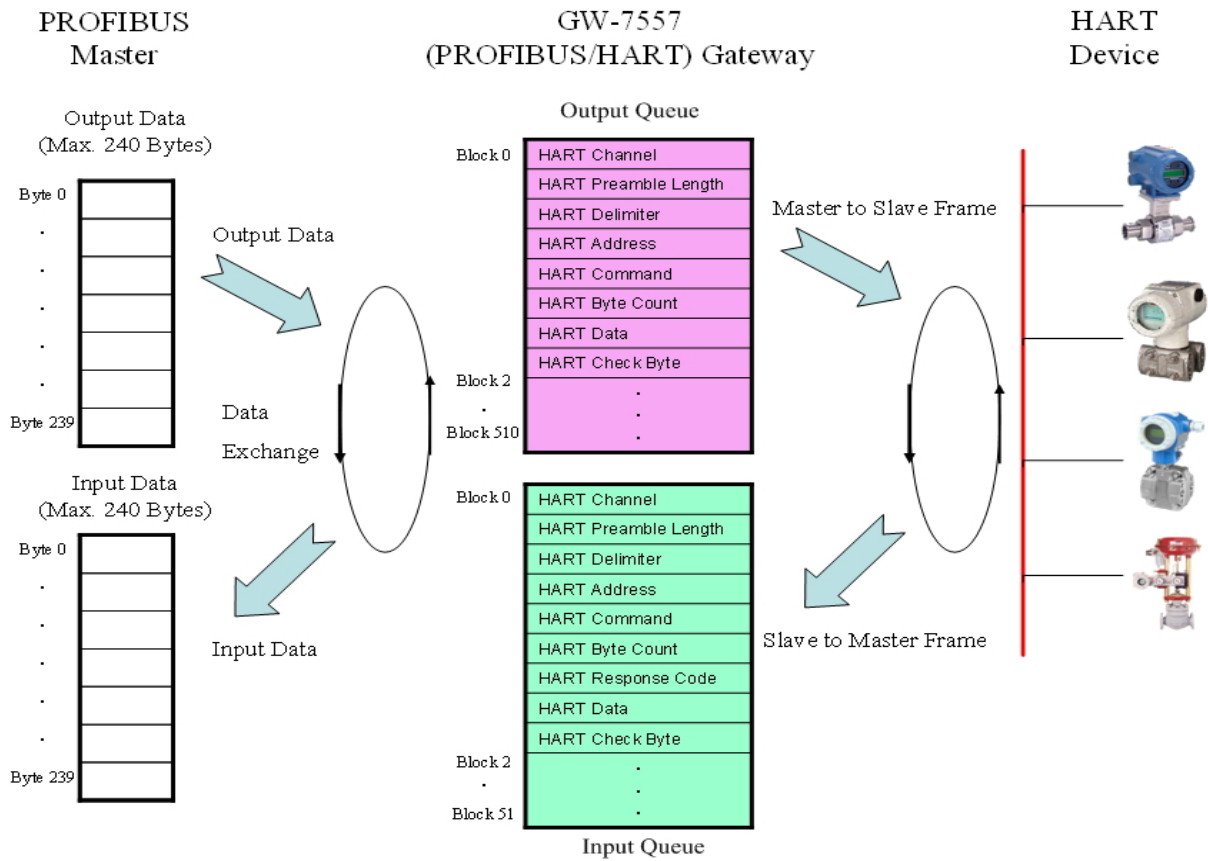

Figure 18 GW-7557 communication protocol transfers

GW-7557 data exchange

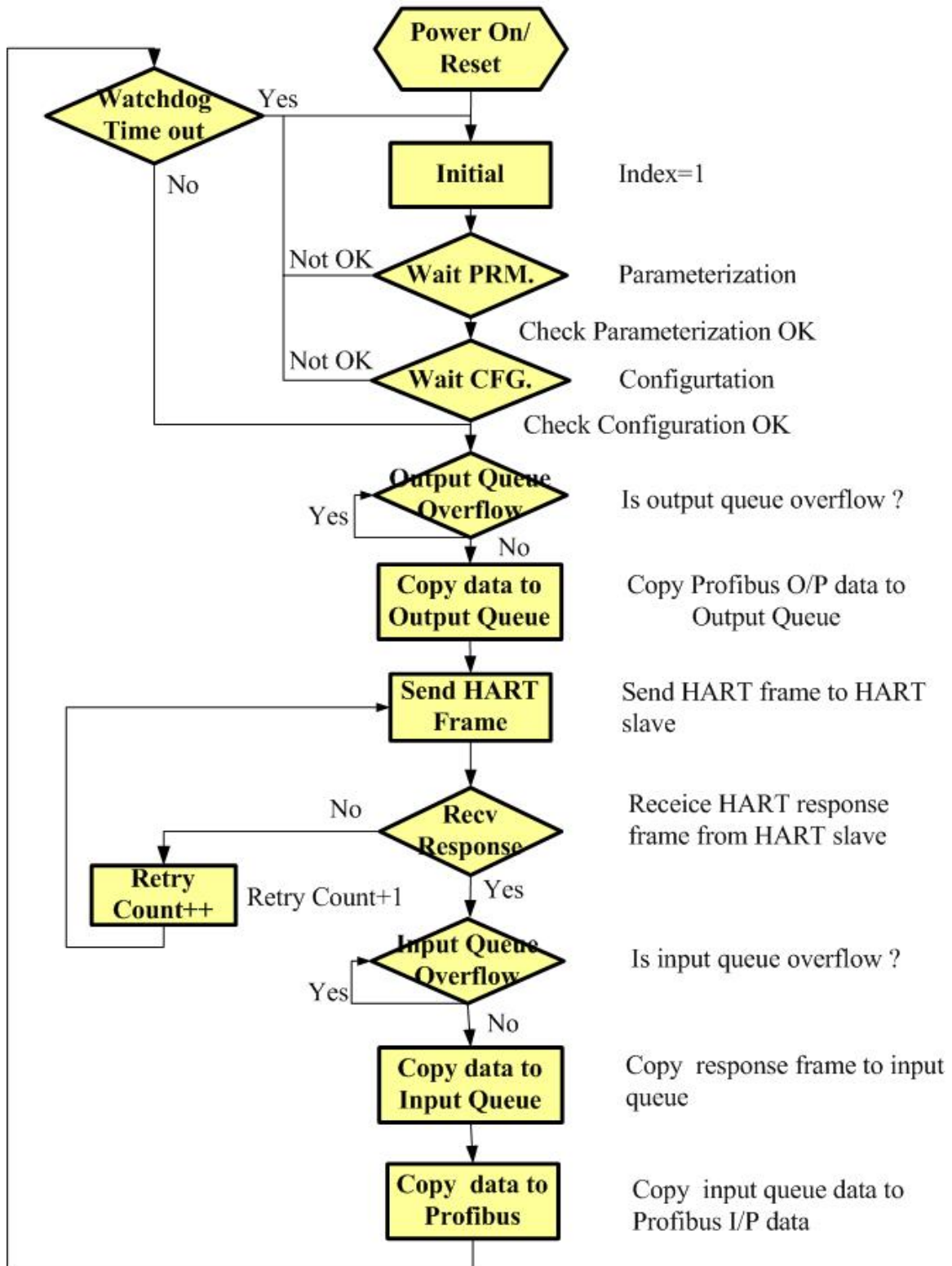

Figure 19 GW-7557 flowchart

4. Communication

4.1 Field of application

A master station can be a PLC, PC or any other smart device. The system can be a mono-master system (*Figure 20*) or a multi-master system (*Figure 21*). The GW-7557 enables the integration of the HART slave devices into a PROFIBUS DP network.



Figure 20 Mono-master system

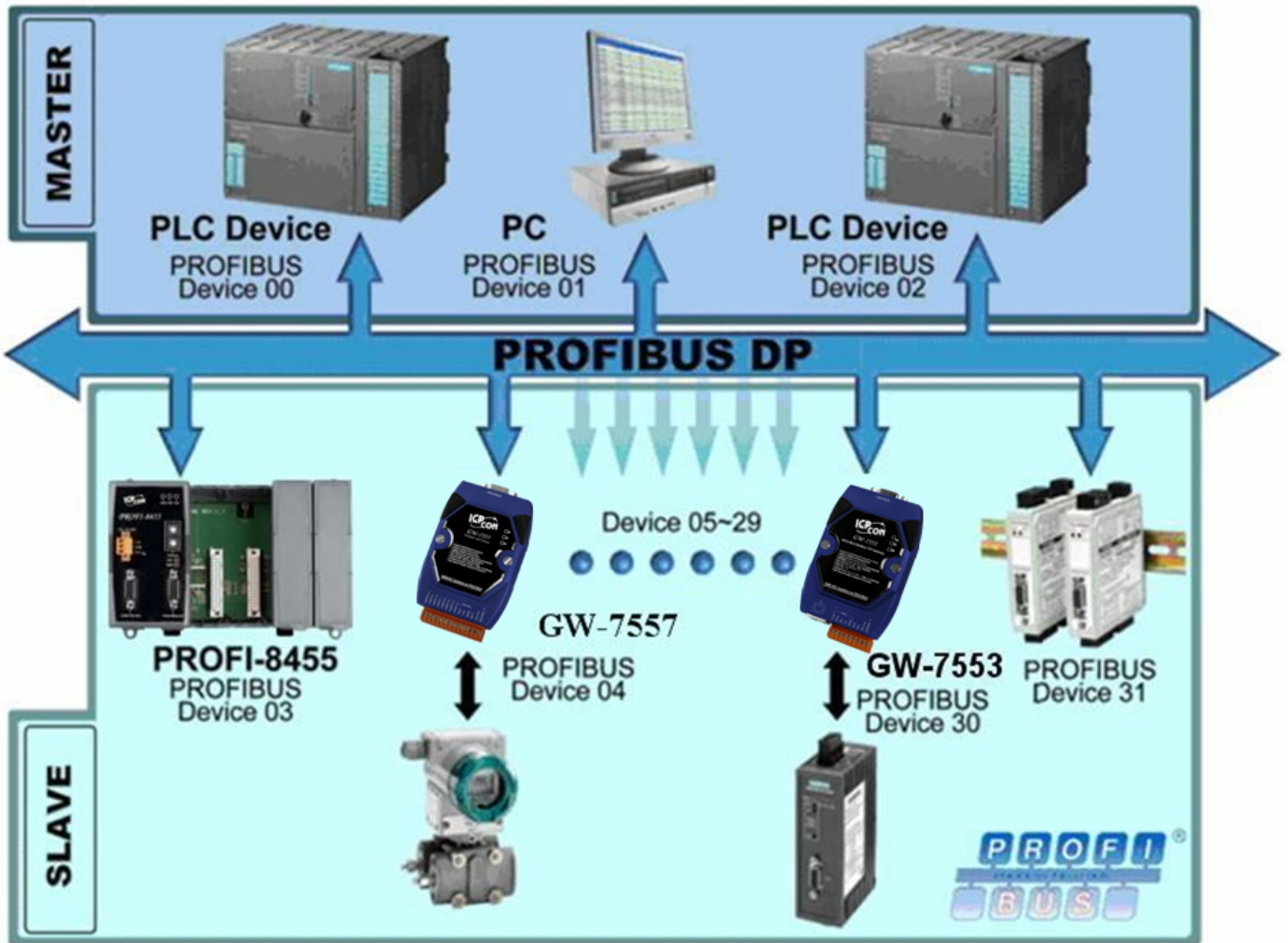

Figure 21 Multi-master system

4.2 GSD file

The characteristic (ex: baud rate, message length, number of input / output data.....) of each PROFIBUS DP device is described in the GSD file. The GSD file of the GW-7557 is in the ICP DAS companion CD-ROM (PATH--> CD: \profibus\gateway\gw-7557\gsd\). The user can copy GSD file (IPDS0D61.gsd) and the Bitmap file (ICP_7557.bmp,GW_7557.bmp) to the PROFIBUS configuration tool.

4.2.1 The example of how to load GSD file

In the following examples the Siemens S7-300 PLC is used. The configuration and communication is done by the program “SIMATIC Manager” provided by Siemens.

Step 1: Open “SIMATIC Manager” tool and select “New Project Wizard” to open a new project.

Step 2: Double Click “Hardware” to open “HW Config”

Step 3: Click “Install GSD File”

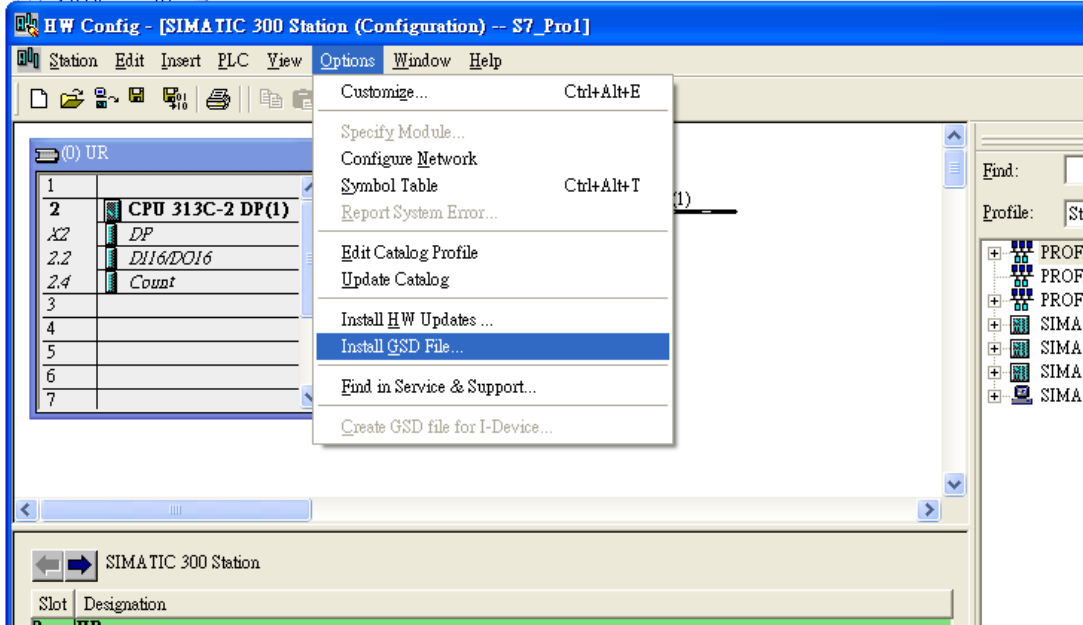

Step 4: Select the directory of GW-7557's GSD file(IPDS0D61.gsd)

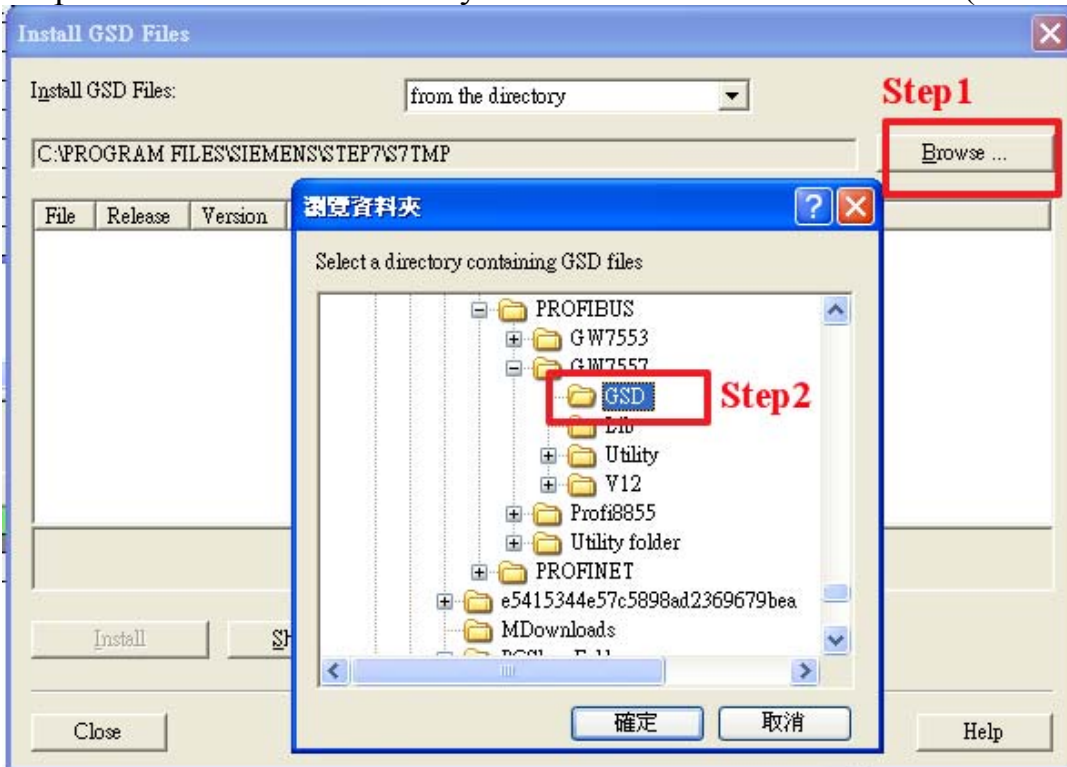

Step 5: Click “Install” button

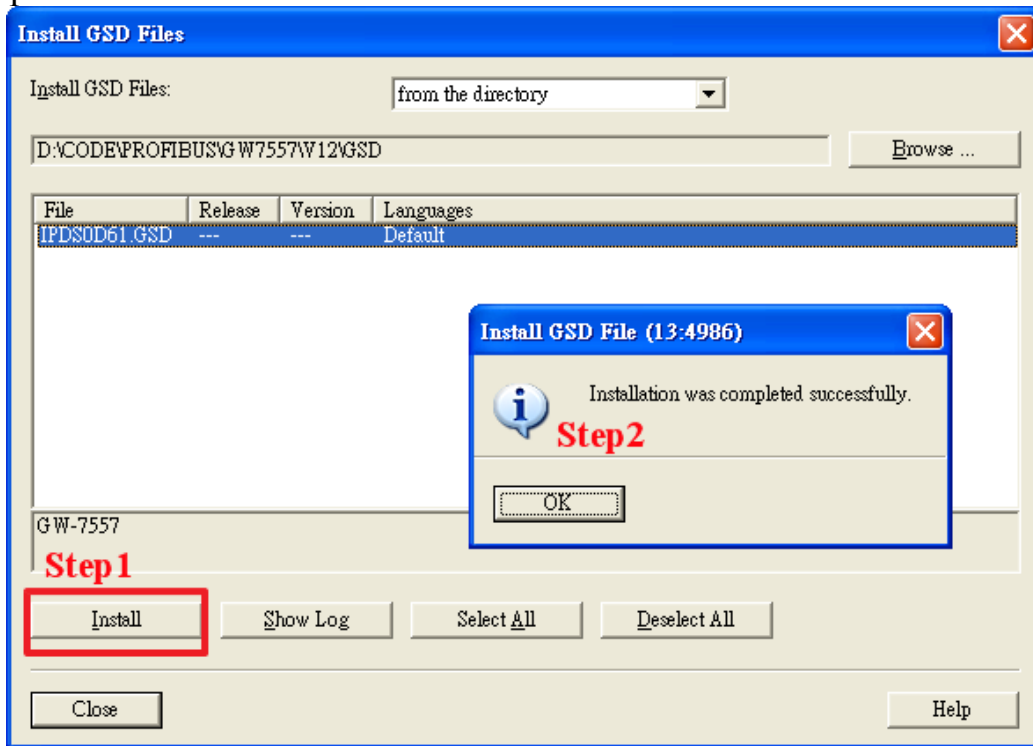

Step 6: Confirm GW-7552’s GSD file is available

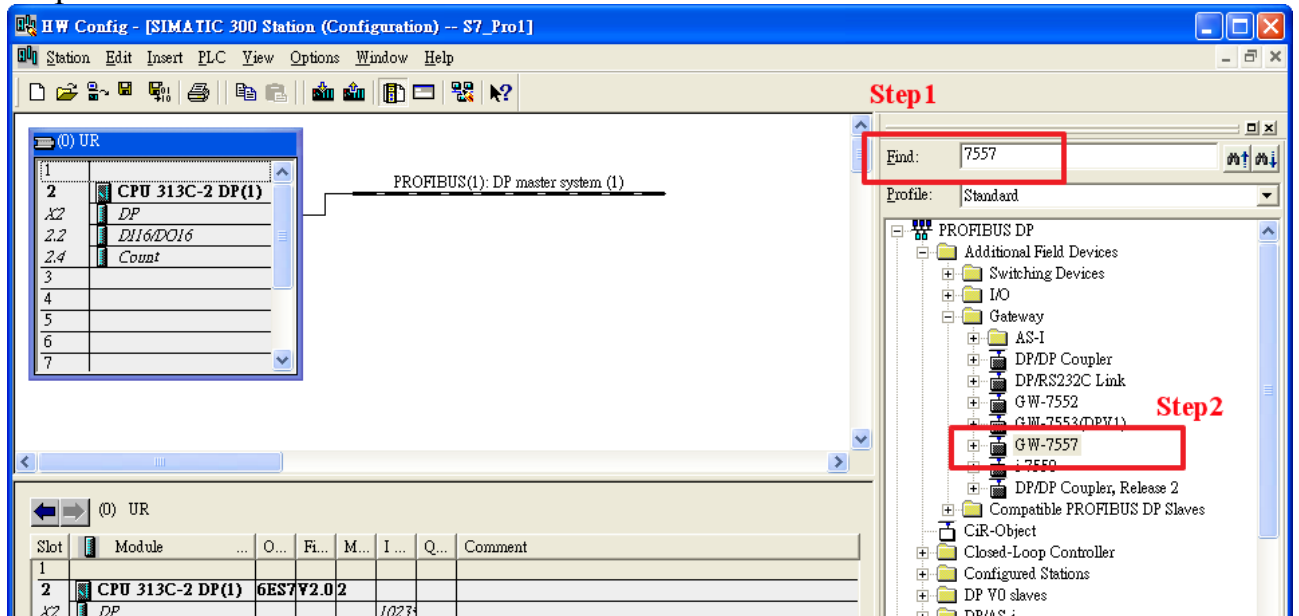

4.3 The Configuration of the common parameters

GW-7557 has twelve common parameters. The user can configure the common parameters to set the communication mode and data format by the PROFIBUS

configuration tool. The common parameters are described below.

- HART Frame Format : Transparent/Compact
- Error Retry Count : 0~5
- HART Command Interval (ms) : 75~65535
- Timeout Value (ms) : 305~65535
- HART Master Type(CH-0) : Primary/Secondary
- HART Master Type(CH-1) : Primary/Secondary
- HART Master Type(CH-2) : Primary/Secondary
- HART Master Type(CH-3) : Primary/Secondary
- HART Network Type(CH-0) : Point to Point/Multi Drop
- HART Network Type(CH-0) : Point to Point/Multi Drop
- HART Network Type(CH-0) : Point to Point/Multi Drop
- HART Network Type(CH-0) : Point to Point/Multi Drop

PS :

- a. Transparent: The user has to fill in HART frame data completely in PROFIBUS output data area and send HART frame to HART slave devices !manually.
Compact: The user has to choose HART command modules which HART slave devices desired. Device configuration of HART slave devices can configure by utility tool.(About how to configure HART slave devices, please refer to section 5.2 for detail)
- b. Error Retry Count: If the HART communication has error, GW-7557 will retry. About the times it is according to this parameter.
- c. HART Command Interval (ms): This parameter will decide the polling interval of HART command.
EX: HART command 1 query → HART command 1 response → wait (cmd interval) → HART command 2 query → HART command 2 response → wait (cmd interval) → ...
- d. Timeout Value (ms): This parameter is about the timeout value of HART command.
- e. HART Master Type: The user can set the master type of HART slave devices. This parameter will decide the HART frame and minimum timeout value. We suggest setting the master type to Primary Master in the general situation.
- f. HART Network Type: The user can set the Network type of HART slave devices. If the network type is “Point to Point”, it means it has only one HART slave device at HART bus. If the network type is “Multi-Drop”, it means it has more than one HART slave device at HART bus.

4.4 The Configuration of the modules

The user can set the number and size of the modules in the PROFIBUS configuration tool. The settings of the modules are described below.

- Max. modules : 110 modules
- System setting module : 13 bytes in, 6 bytes out
- Output module : Output Words => 4~48 Words
- Input module : Input Words => 8~48 Words
- HART command module : Support universal and common command
- Max. length of I/O data : 480 Bytes
- Length of output data : 0~240 Bytes
- Length of input data : 0~240 Bytes

Note:

The user must add “System setting module” at the first module before the other modules, else the GW-7557 will send the diagnostic messages to PROFIBUS Master and the system will be abnormal.

The modules have module parameters about the communication settings. The module parameters are shown in the below :

A. HART command module parameters :

- Channel Number : Channel 0 ~ Channel 3
- Device Number : Device 0 ~ Device15
- Output Mode : Initial/Polling/Manual/Burst

Example 1:

If the user wants to read primary variable(command 1). HART slave device connects with HART channel 2 of GW-7557, preamble length is 5、long address is 0xFB 0x01 0x00 0x12 0x67, network type of HART channel 2 is point to point.

In this case, the user should select the following modules:

1. Transparent mode :

The user can select a “4 Words Output module” and a “8 Words Input module”.

2. Compact mode :

The user can select a “Command 1 module” , module parameters are shown in

the below:

Command 1 module parameters :

- Channel Number : Channel 2
- Device Number : Device 0
- Output Mode : Polling

Example 2:

If the user wants to enable burst mode and read primary variable by using burst mode. HART slave device connects with HART channel 3 of GW-7557, preamble length is 5 、 long address is 0xFB 0x01 0x00 0x12 0x67, network type of HART channel 3 is point to point.

In this case, the user should select the following modules:

1. Transparent mode :

The user can select a “8 Words Output module” and a “8 Words Input module”.

2. Compact mode :

The user can select a “Command 108 module” 、 a ”Command 109 module” and a “Command 1 module” , module parameters are shown in the below:

Command 108 module parameters :

- Channel Number : Channel 3
- Device Number : Device 0
- Output Mode : Manual

Command 109 module parameters :

- Channel Number : Channel 3
- Device Number : Device 0
- Output Mode : Manual

Command 1 module parameters :

- Channel Number : Channel 3
- Device Number : Device 0
- Output Mode : Burst

PS :

- a. Channel Number : This parameter will decide HART channel of HART

slave device.

b. Device Number : This parameter will decide device number of HART slave device. Device number must increase in order(ex: 3 HART slave devices, Device Number is Device 0 、 Device 1 、 Device 2).

c. Output Mode :

- Initial => When GW-7557 start, it will send this command once.
- Polling => GW-7557 will poll all polling command.
- Manual => The user must send this command manually(Please refer to section 4.6.2).
- Burst => GW-7557 will receive burst frame of this command.

4.5 Diagnostic messages

The GW-7557 can show maximally 15 diagnostic messages at the same time. If the number of the diagnostic messages is bigger than 15, the GW-7557 will not process other diagnostic message. The diagnostic messages have 5 types. They are “Command Response Error”, “System Setting Module Error”, “Output Data Error” 、 “Input Data Error” and “EEPROM Error”. The diagnostic messages are shown in *Table 8*.

Table 8 Diagnostic messages

Modules	Messages	Description
Module 2~111	Command Response Error	Receive TimeOut
		Receive DATA Too Short
		Delimiter ERROR
		Address Master ERROR
		Address Burst ERROR
		Receive Command Number ERROR
		Parity Check ERROR
Transparent Module		Invalid selection
		Passed parameter too large
		Passed parameter too small
		Too few data bytes received
		In write-protect mode
		Access restricted
		Device is busy
Module 1		System setting module Error
	Not find System setting module. Position is not correct!	
N/A	Output Data Error	FIFO overflow
		Lose PROFIBUS output data

		Output Channel out of Range
		Preamble length out of Range
		Output Mode is not Manual mode
		Burst Frame On HART BUS
		Burst modules too much
		Choose Wrong Module
N/A	Input Data Error	FIFO overflow
N/A	EEPROM Error	Read Data from EEPROM ERROR
		Write Data to EEPROM ERROR

PS:

Output Data Error :

- a. When GW-7557 receives a “data output command” (output byte 0) from system setting module, and this command didn’t increase in order (ex: 0->1, 1->2,..., 255->0), the GW-7557 will think that it lose some output data of the PROFIBUS Master and a diagnostic message (“Lose PROFIBUS output data”) will be sent by the GW-7557 to the PROFIBUS master.
- b. When GW-7557 receives a “HART channel” (output byte 3) from system setting module, and this value is greater than 3, then a diagnostic message (“Output Channel out of Range”) will be send by the GW-7557 to the PROFIBUS master.
- c. When GW-7557 receives a “Preamble length” (output byte 4) from system setting module, and this value is less than 5 or greater than 20, then GW-7557 will set preamble length to 20 automatically and a diagnostic message (“Preamble length out of Range”) will be send by the GW-7557 to the PROFIBUS master.
- d. If HART Frame Format is “Compact”. When GW-7557 receives a “Output module” (Output byte 2) from system setting module, and “Output Mode” of this module isn’t manual, then a diagnostic message (“Output Mode is not Manual mode”) will be send by the GW-7557 to the PROFIBUS master.
- e. If GW-7557 detect burst frame at a certain HART channel. When user wants to send HART command from this channel, then a diagnostic message (“Burst Frame On HART Bus”) will be send by the GW-7557 to the PROFIBUS master.
- f. GW-7557 just allow only one burst module (Output Mode is Burst). If the number of burst modules are more than one, then a diagnostic message (“Burst modules too much”) will be send by the GW-7557 to the PROFIBUS master.
- g. If HART Frame Format is “Transparent”, user just can select Output length module or Input length module; If HART Frame Format is “Compact”, user just can select HART Command module; When user select wrong module, then a diagnostic message (“Choose Wrong Module”) will be send by the

GW-7557 to the PROFIBUS master.

4.6 I/O data exchange

4.6.1 Input data area

The maximum length of input data is 240 bytes. Before arrange “Input module” or “HART Command module”, the user must arrange and configure the “system setting module”. The user can get data form HART slave devices by “read Input module” or “HART Command module”.

Table 9 Input data area

Module	Byte	Data	Description
System Setting module	0	Data	The number of HART commands that have to be sent
	1		
	2	Data	The number of HART commands that have been sent
	3		
	4	Data	The number of HART commands that have been received
	5		
	6	Data	The number of HART commands that have error occurred
	7		
	8	Data	The ID of HART command that have error occurred in the Output queue
	9		
	10	0~3	The channel number of response frame
	11	Data	The length of the response frame
	12	1~255	The capacity of Output Queue
Input module Or HART Command module	13~239	Data	Receive data

- Data input command (byte 11)
The length of response frame does not include preamble and check byte.

- Data input command (byte 12)

The capacity of Output Queue is from 1 to 255. One level means there are level*2 or level*2-1 HART command in the Output Queue. (ex: level 5 means there are 9 or 10 HART commands in the Output Queue)

4.6.2 Output data area and communication command

The maximum length of output data is 240 bytes. Before arrange the output module, the user must arrange and configure the system setting module. The first six bytes belong to communication commands, as shown in *table 13*.

Table 10 Output data area

Module	Byte	Data	Description
System Setting module	0	Data	Data output command
	1	0x01	Control bit
	2	Data	Output HART Command module select (for Compact)
	3	0~3	Output HART channel (for Transparent)
	4	5~20	Output preamble length (for Transparent)
	5	Data	Output HART frame length (for Transparent)
Output module Or HART Command module	6~239	Data	Output data

- Data output command(byte 0)

When this byte is changed, PROFIBUS Master device will send data of output module to Output Queue of GW-7557 and then GW-7557 will send HART frame to HART slave device.

PS: When the user use this byte to trigger “data output command”, the user must increase this byte in order (ex: 0->1, 1->2,..., 255->0) or else the GW-7557 will send a diagnostic message to the PROFIBUS master (please refer section 4.5 Diagnostic messages).

- Control bit(byte 1)

Bit 0 : When this bit is set to 1, diagnostic messages sent by the

GW-7557 module will all be cleared.

Bit 1~7 : The remaining bits have to be set to zero.

- Output HART Command module select (byte 2)
If HART Frame Format is “Compact”, when this byte isn’t ‘0’ and the user change data output command (byte 0), it will trigger single data output command of the HART Command module (Output Mode is Manual) and this byte represent module address of the output module (ex: “byte 2”=3, it represent that the user want to trigger data output command of the third module)
- Output HART channel (byte 3)
If HART Frame Format is “Transparent”, user can set the HART channel for HART command. The range is 0~3.
- Output preamble length (byte 4)
If HART Frame Format is “Transparent”, user can set the preambles for HART command. The range is 5~20.
- Output HART frame length (byte 5)
If HART Frame Format is “Transparent”, this byte represent frame length of HART frame (exclude preamble length and check byte; ex: send command 0 by using short frame, “byte 5”=4, it represent that delimiter
(1 byte)+short address(1 byte)+command number(1 byte)+byte count(1 byte)).

4.7 Establish connection with GW-7557

Before establishing a connection between the DP-Master and the GW-7557, user should execute the following steps first, as shown in *Figure 22*.

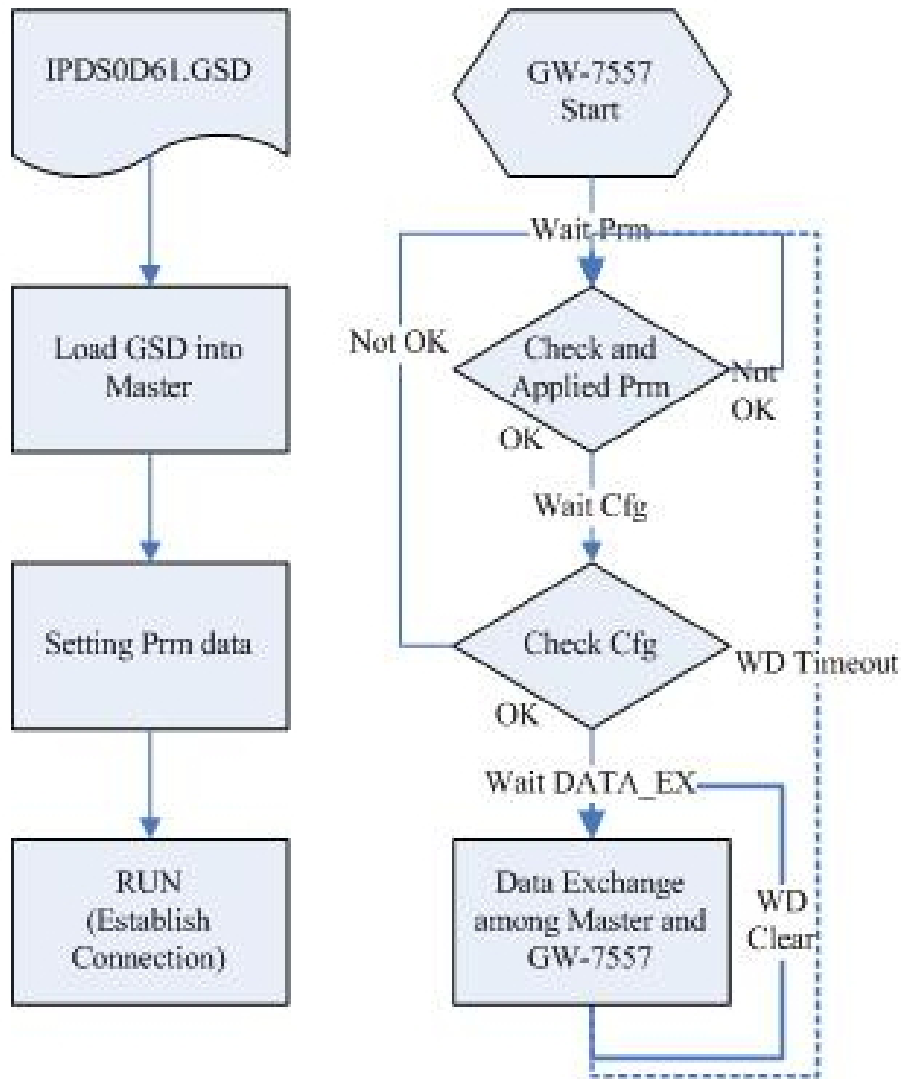

Figure 22 Establish connection with GW-7557

First, users must load the electronic device description file (GSD file) of the GW-7557 into the DP-Master, and then set the parameters. Finally change your DP-Master from Offline state to Operate state. While DP-Master changes to operate mode, GW-7557 will initial the modules. Then GW-7557 allocates the memory space and waits for Set_Prm telegram. The next step is waiting for Check_Cfg telegram in order. If there is no error occurs, GW-7557 proceeds into data exchange state. Users can observe the status indicator LED to know the state of GW-7557. At the meantime, if there is any error occurs, GW-7557 will return to wait parameterization.

4.8 Data exchange example — Transparent format

In this example, we use Siemens S7-300 PLC (as a PROFIBUS master) 、 a GW-7557 (as a PROFIBUS slave/HART master) and a HART slave device to read primary variable of HART slave device.

- Step 1: Copy the GSD file (Please refer to the section 4.2) and assign the GW-7557 a valid station address (Please refer to the section 2.4).
- Step 2: Connect the RS-232 port of the GW-7557 module to a COM port of the PC and the PROFIBUS port to a PROFIBUS master (*Figure 23*).

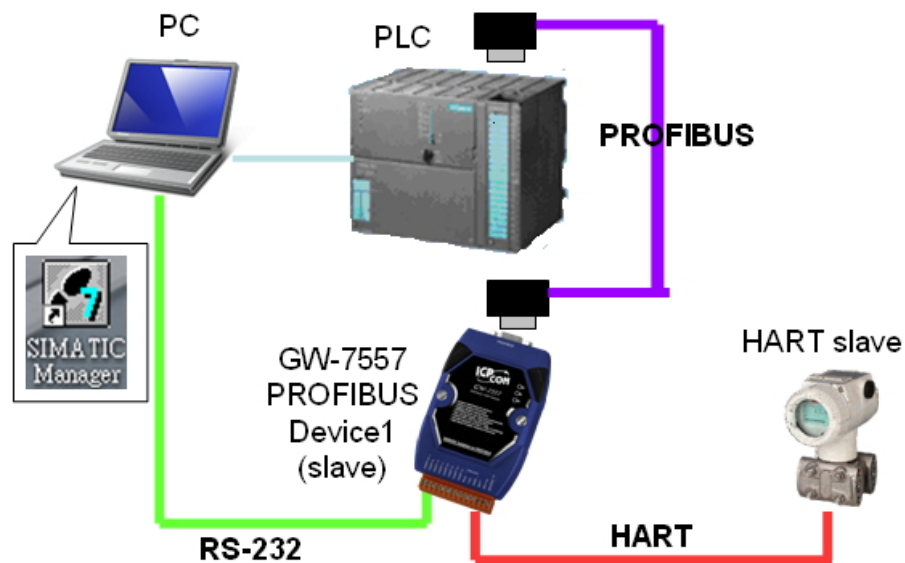

Figure 23 Wiring diagram between PC and GW-7557

- Step 3: Set the parameters of the GW-7557. We just need to change “HART Frame Format” to Transparent and the default setting is being used in the other parameters for this example. Please refer to section 4.3 the Configuration of the common parameters. The users can set parameters as shown in the below (*Figure 24*).

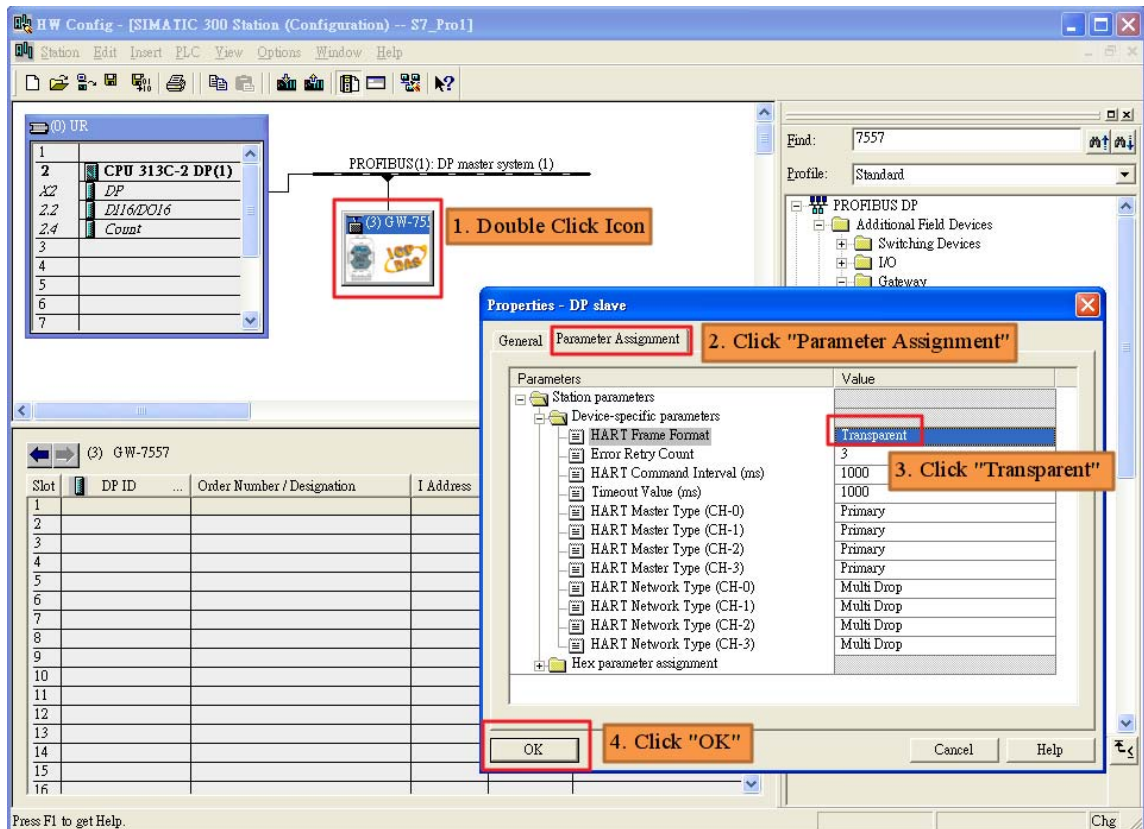

Figure 24 Parameter settings of GW-7557

Step 4: Set the GW-7557 modules, as shown in Figure 25

- Select “System setting” module: “System setting” module always has to be selected otherwise no communication can be established between the gateway and the Modbus network.
- Select “Output module” module: In this example a “16 Words Output” module is selected.
- Select “Input module” module: In this example a “16 Words Input” module is selected.

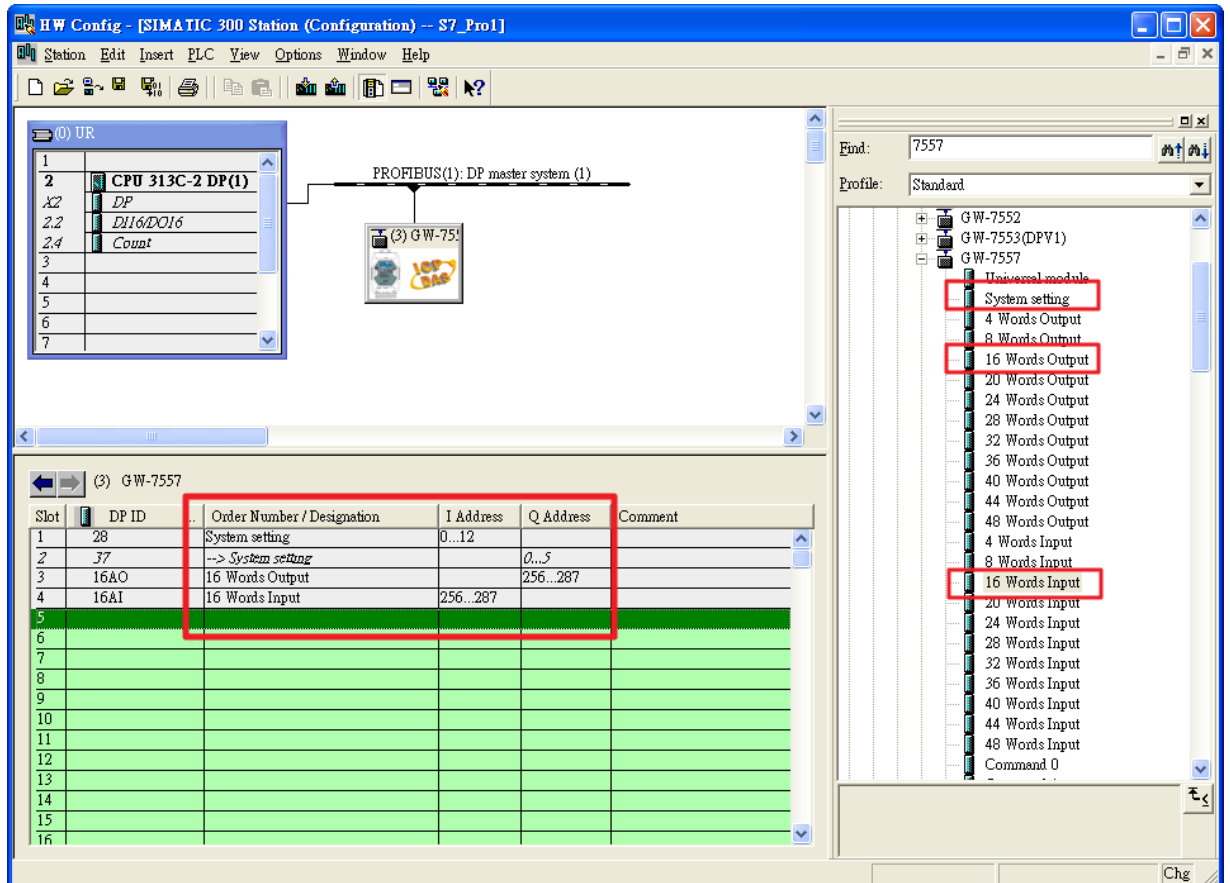

Figure 25 Select modules

Step 5: Click <Save and Compile> then click <Download> to download the configuration into PROFIBUS master, as shown in Figure 26 and Figure 27.

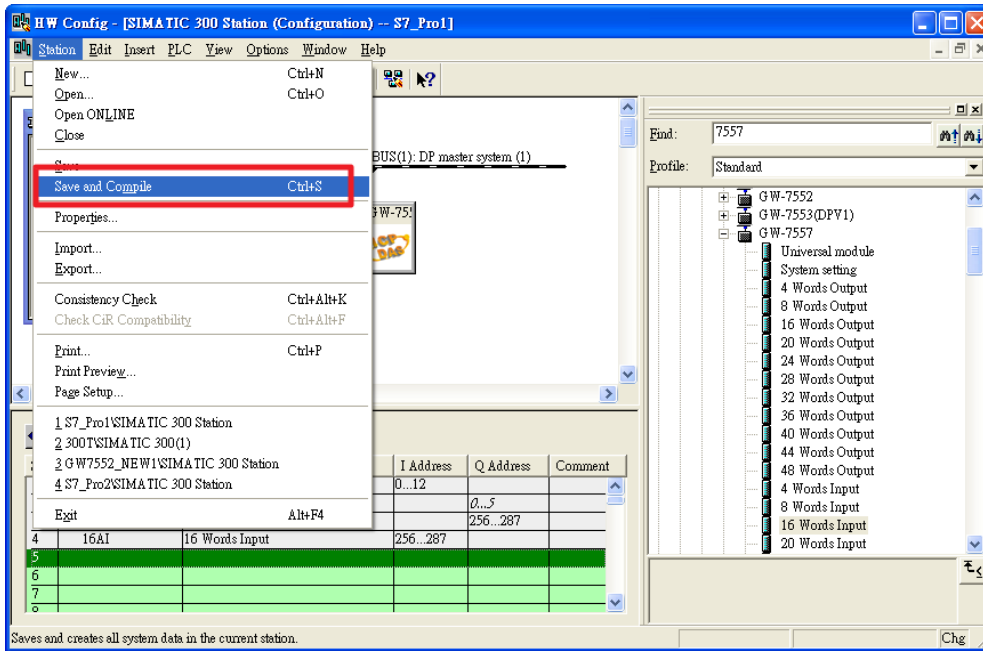

Figure 26 Click <Save and Compile>

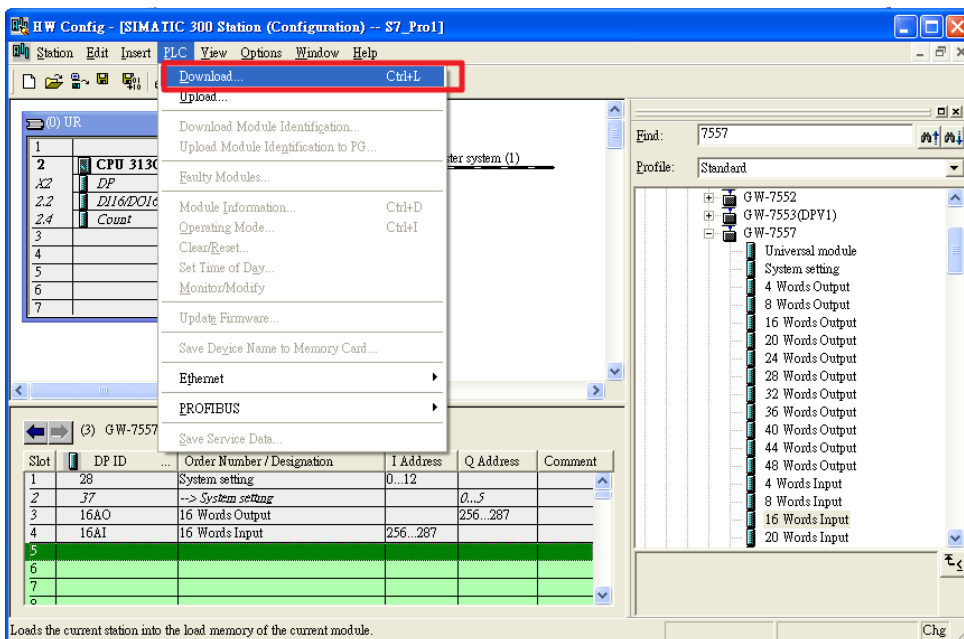

Figure 27 Click <Download> to download configuration into PROFIBUS master

Note:

In this example, device configurations of HART slave device are listed as follows.

- HART channel : channel 2
- Preamble length : 0x07
- HART frame type : Long frame

- Manufacturer ID : 0x16
- Device type : 0x85
- Device ID : 0x0B0A42

4.8.1 Communication test between PROFIBUS and HART

(1) Establish output variable table

Click Monitor/Modify Variables in main windows to establish variable table 1 and fill in address of PROFIBUS output area. Input “0x82 0x96 0x85 0x0A 0x0B 0x42 0x01 0x00” in output data area of 16 Words Output module and input “1 0 0 2 7 8” in output data area of system setting module (Please refer to section 4.6.2), as shown in *Figure 28*、*Figure 29* and *Figure 30*.

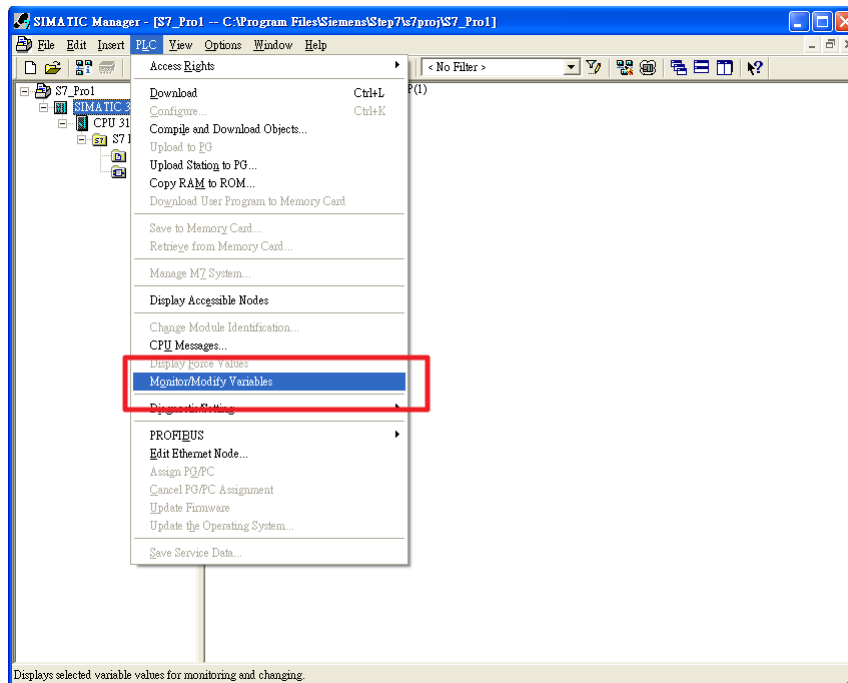

Figure 28 Click <Monitor/Modify Variables>

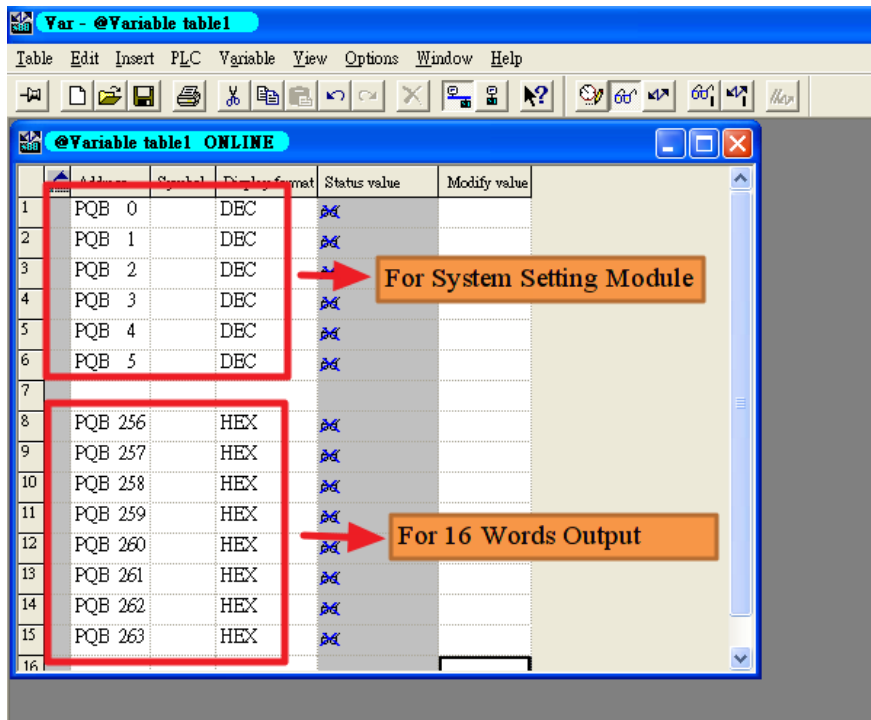

Figure 29 fill in address of PROFIBUS output area

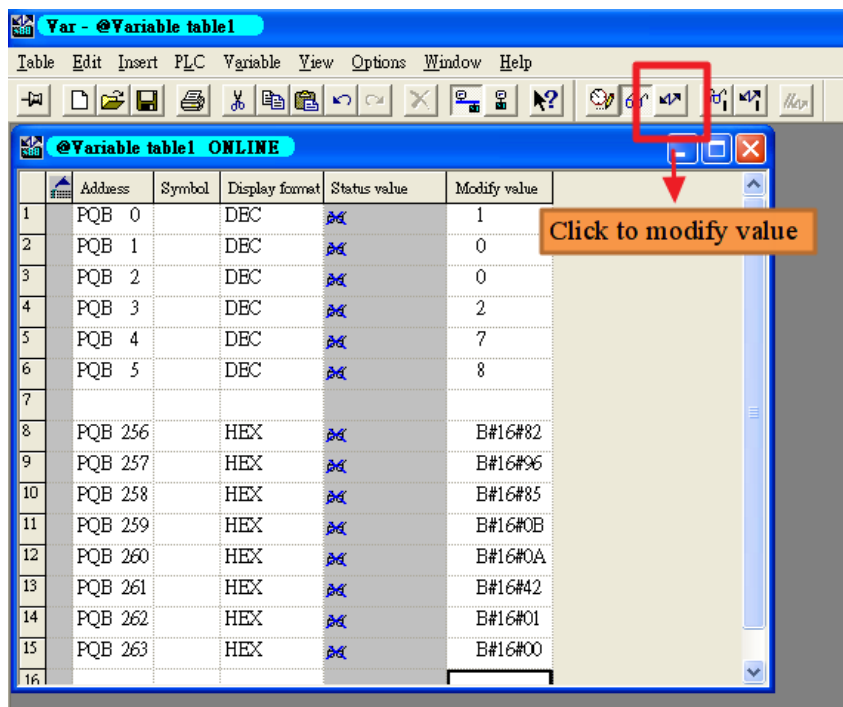

Figure 30 fill in HART frame

(2) Establish input variable table

Click Monitor/Modify Variables in main windows to establish variable table 2 and fill in address of PROFIBUS input area. It shows “1 1 1 0 0 2 15 0” in input area of system setting module and shows “0x86 0x96 0x85

0x0B 0x0A 0x42 0x01 0x07 0x00 0x10 0x0C 0x3E 0xC8 0x8A 0x70” in input are of 16 Words Input module (Please refer to section 4.6.1), The value of primary variable is 0.3916812, as shown in *Figure 31* and *Figure 32*.

Address	Symbol	Display format	Status value	Modify value
1	PIW 0	DEC	0	
2	PIW 2	DEC	0	
3	PIW 4	DEC	0	
4	PIW 6	DEC	0	
5	PIW 8	DEC	0	
6	PIB 10	DEC		
7	PIB 11	DEC		
8	PIB 12	DEC	0	
9				
10	PIB 256	HEX	E#16#00	
11	PIB 257	HEX	E#16#00	
12	PIB 258	HEX		
13	PIB 259	HEX		
14	PIB 260	HEX	E#16#00	
15	PIB 261	HEX	E#16#00	
16	PIB 262	HEX	E#16#00	
17	PIB 263	HEX	E#16#00	
18	PIB 264	HEX	E#16#00	
19	PIB 265	HEX	E#16#00	
20	PIB 266	HEX	E#16#00	
21	PIB 267	HEX	E#16#00	
22	PIB 268	HEX	E#16#00	
23	PIB 269	HEX	E#16#00	
24	PIB 270	HEX	E#16#00	
25	PIB 267	FLOATING_POINT	0.0	

Figure 31 fill in address of PROFIBUS output area

	Address	Symbol	Display format	Status value	Modify value
1	PIW 0		DEC	1	
2	PIW 2		DEC	1	
3	PIW 4		DEC	1	
4	PIW 6		DEC	0	
5	PIW 8		DEC	0	
6	PIB 10		DEC	2	
7	PIB 11		DEC	15	
8	PIB 12		DEC	0	
9					
10	PIB 256		HEX	E#16#86	
11	PIB 257		HEX	E#16#96	
12	PIB 258		HEX	E#16#85	
13	PIB 259		HEX	E#16#0B	
14	PIB 260		HEX	E#16#0A	
15	PIB 261		HEX	E#16#42	
16	PIB 262		HEX	E#16#01	
17	PIB 263		HEX	E#16#07	
18	PIB 264		HEX	E#16#00	
19	PIB 265		HEX	E#16#10	
20	PIB 266		HEX	E#16#0C	
21	PIB 267		HEX	E#16#3E	
22	PIB 268		HEX	E#16#C8	
23	PIB 269		HEX	E#16#8A	
24	PIB 270		HEX	E#16#70	
25	PID 267		FLOATING_POINT	0.3916812	

Figure 32 Response data of HART frame

Note:

HART frame :

Master to Slave frame

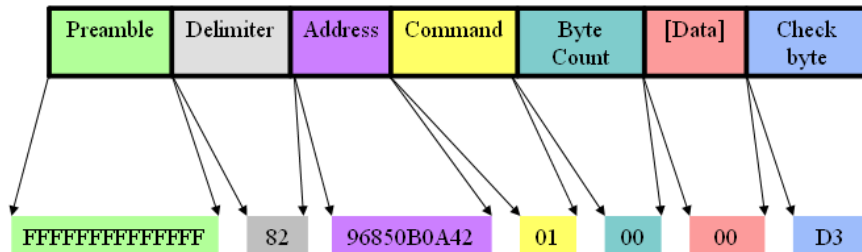

Slave to Master frame

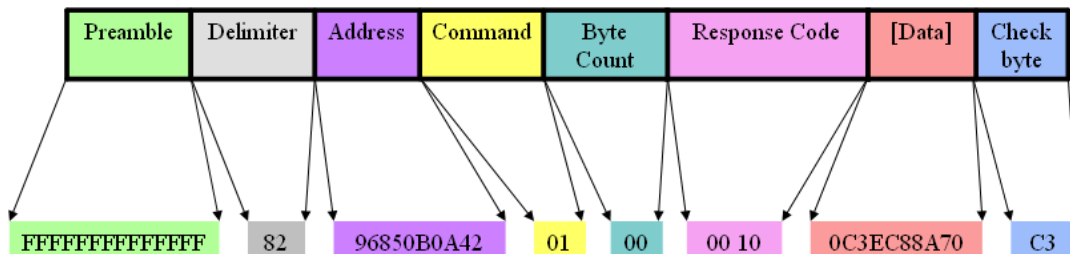

4.9 Data exchange example — Compact format

In this example, we use Siemens S7-300 PLC (as a PROFIBUS master) 、 a GW-7557 (as a PROFIBUS slave/HART master) and a HART slave device to read primary variable of HART slave device.

Step 1: Copy the GSD file (Please refer to the section 4.2) and assign the GW-7557 a valid station address (Please refer to the section 2.4).

Step 2: Connect the RS-232 port of the GW-7557 module to a COM port of the PC and the PROFIBUS port to a PROFIBUS master (*Figure 33*).

Step 3: Set the parameters of the GW-7557. We just need to change “HART Frame Format” to Compact and the default setting is being used in the other parameters for this example. Please refer to section 4.3 the Configuration of the common parameters. The users can set parameters as shown in the below (*Figure 34*).

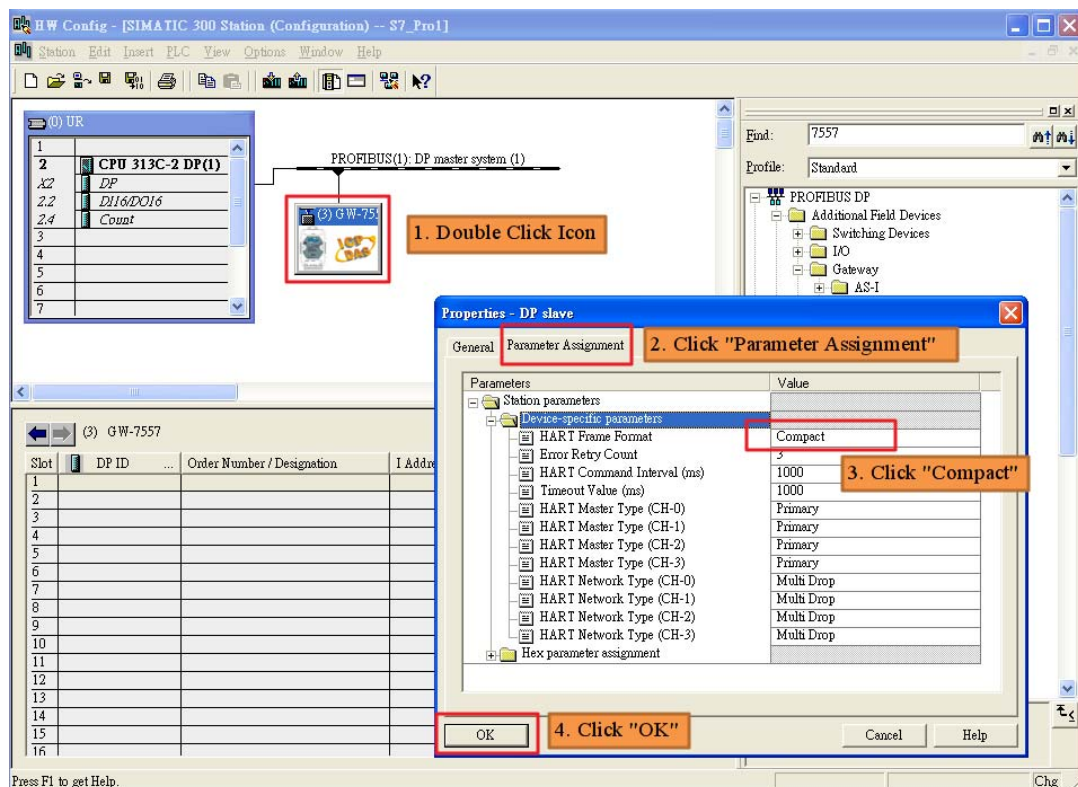

Figure 34 Parameter settings of GW-7557

Step 4: Set the GW-7557 modules, as shown in *Figure 35* and *Figure 36*.

- Select “System setting” module: “System setting” module always has to be selected otherwise no communication can be established

between the gateway and the Modbus network.

- Select “HART Command module” module: In this example a “Command 1” module is selected.

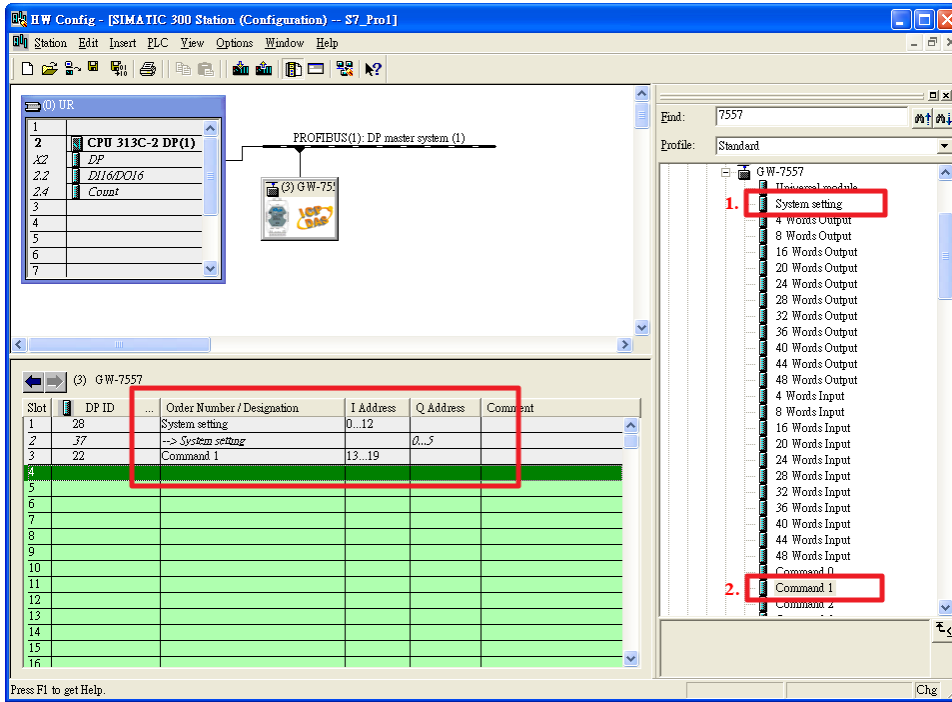

Figure 35 Select modules

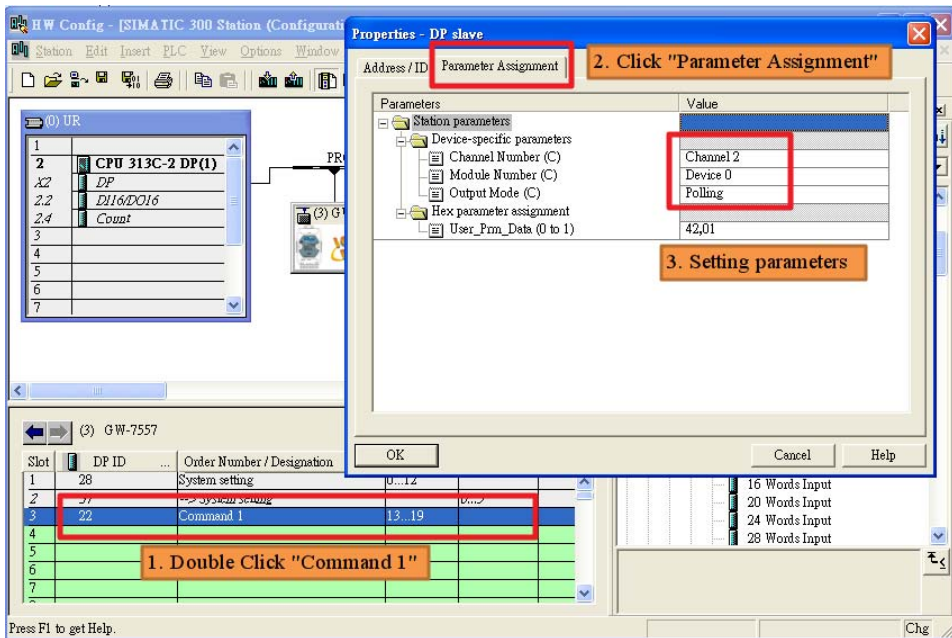

Figure 36 Set module parameters of Command 1 module

Step 5: Click <Save and Compile> then click <Download> to download the configuration into PROFIBUS master, as shown in Figure 37 and

Figure 38.

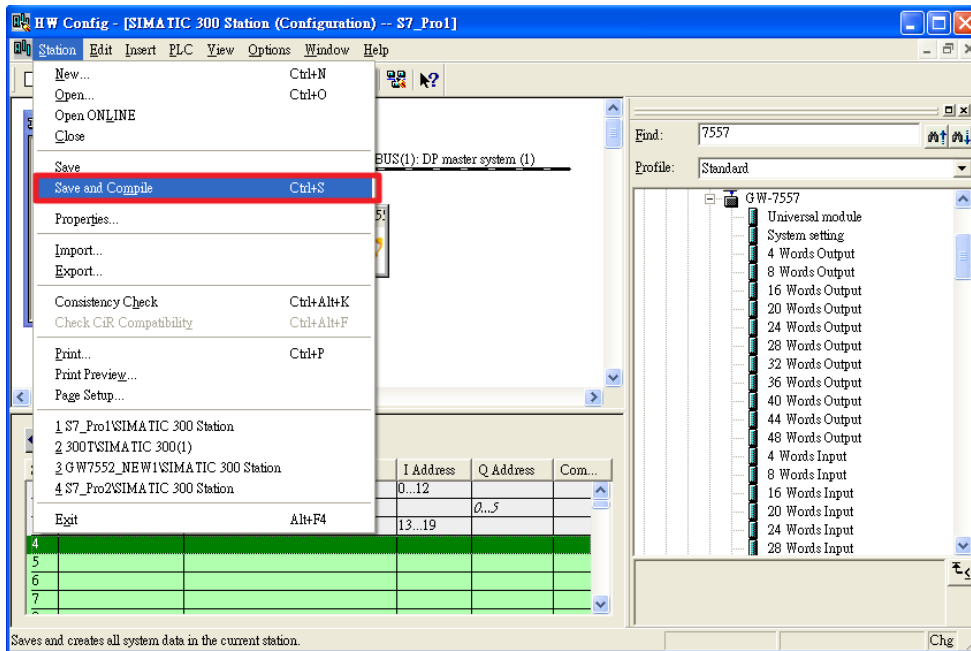

Figure 37 Click <Save and Compile>

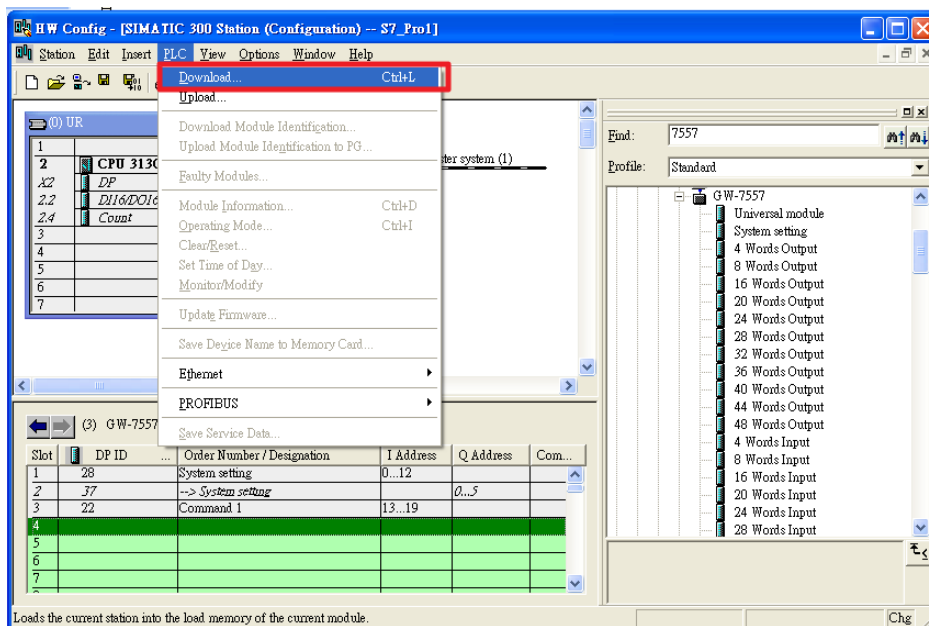

Figure 38 Click <Download> to download configuration into PROFIBUS master

Step 6: Set the device configurations of HART slave device by using PROFIBUS/HART gateway utility (please refer section 5.2).

Step 7: Reset the power of the GW-7557 for an active setting.

Note:

In this example, device configurations of HART slave device are listed as follows.

- HART channel : channel 2
- Preamble length : 0x07
- HART frame type : Long frame
- Manufacturer ID : 0x16
- Device type : 0x85
- Device ID : 0x0B0A42

4.9.1 Communication test between PROFIBUS and HART

(1) Establish input variable table

Click Monitor/Modify Variables in main windows to establish variable table 1 and fill in address of PROFIBUS input area. The value of PIW0、PIW2、PIW4 increase in order, and the value of PIB13~PIB19 always change. It means GW-7557 sends query frame of command 1 to HART slave and receives response frame of command 1 from HART slave continuously, as shown in *Figure 39* and *Figure 40*.

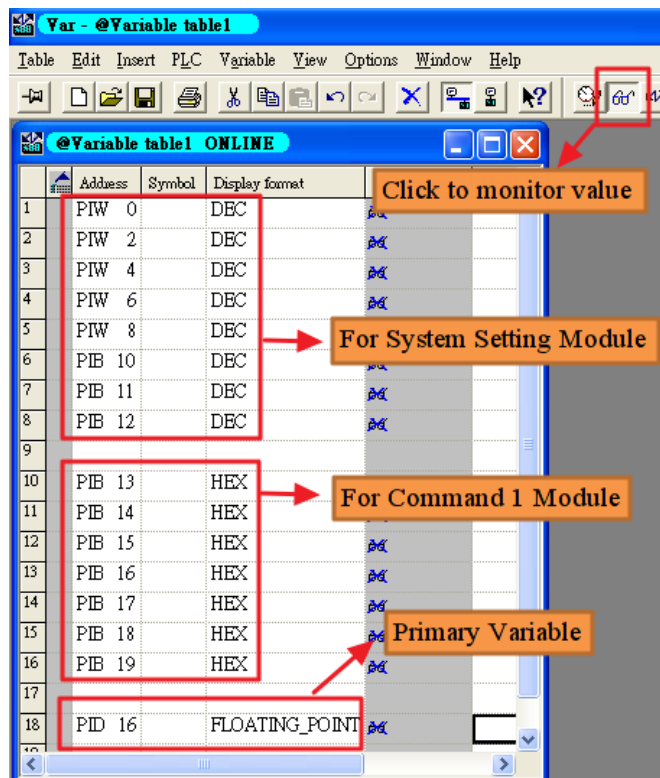

Figure 39 fill in address of PROFIBUS input area

	Address	Symbol	Display format	Status value	Modifi
1	PIW 0		DEC	122	
2	PIW 2		DEC	121	
3	PIW 4		DEC	121	
4	PIW 6		DEC	0	
5	PIW 8		DEC	0	
6	PIB 10		DEC	2	
7	PIB 11		DEC	15	
8	PIB 12		DEC	1	
9					
10	PIB 13		HEX	B#16#00	
11	PIB 14		HEX	B#16#00	
12	PIB 15		HEX	B#16#0C	
13	PIB 16		HEX	B#16#3E	
14	PIB 17		HEX	B#16#C9	
15	PIB 18		HEX	B#16#06	
16	PIB 19		HEX	B#16#78	
17					
18	PID 16		FLOATING_POINT	0.3926275	

Figure 40 Response data of Command 1

Note:

HART frame :

Master to Slave frame

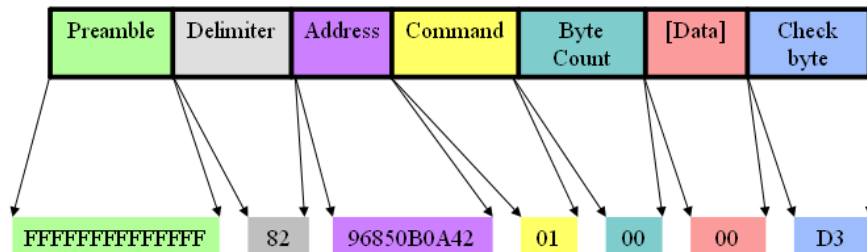

Slave to Master frame

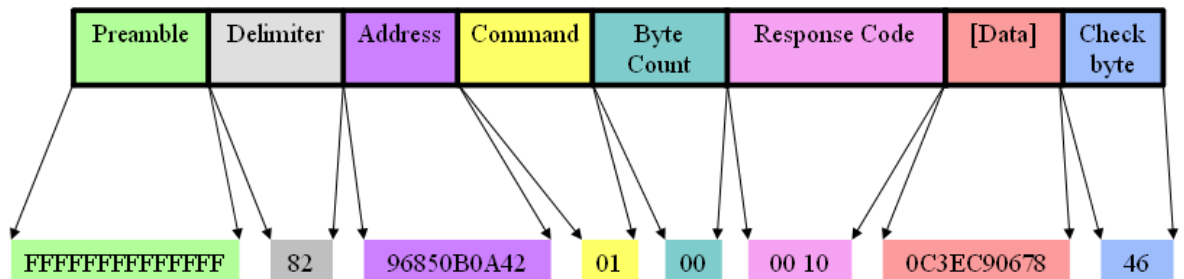

4.9.1 Burst mode test

(1) Set the GW-7557 modules

Select modules and download the configuration into PRORFIBUS master, as shown in *Figure 41* and *Figure 42*.

- Select “System setting” module: “System setting” module always has to be selected otherwise no communication can be established between the gateway and the Modbus network.
- Select “HART Command module” module: In this example a “Command 1” module is selected.
- Select “HART Command module” module: In this example a “Command 108” module is selected.
- Select “HART Command module” module: In this example a “Command 109” module is selected.

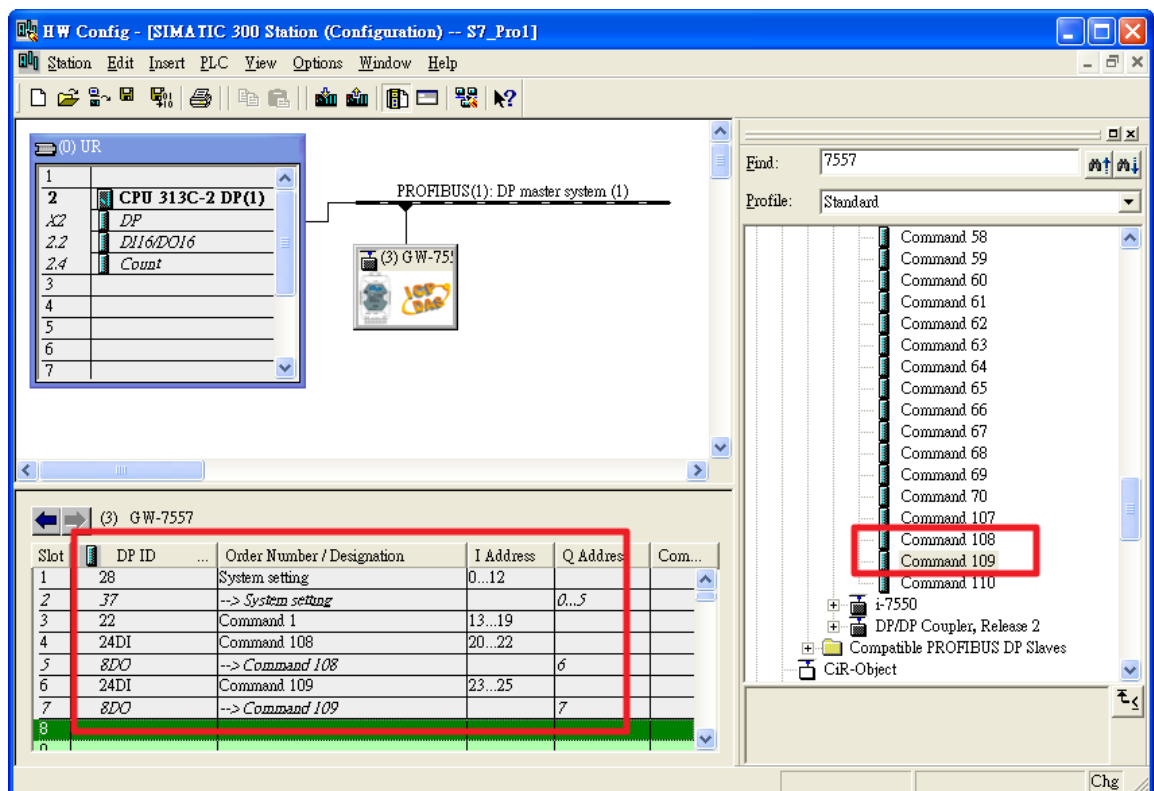

Figure 41 Select modules

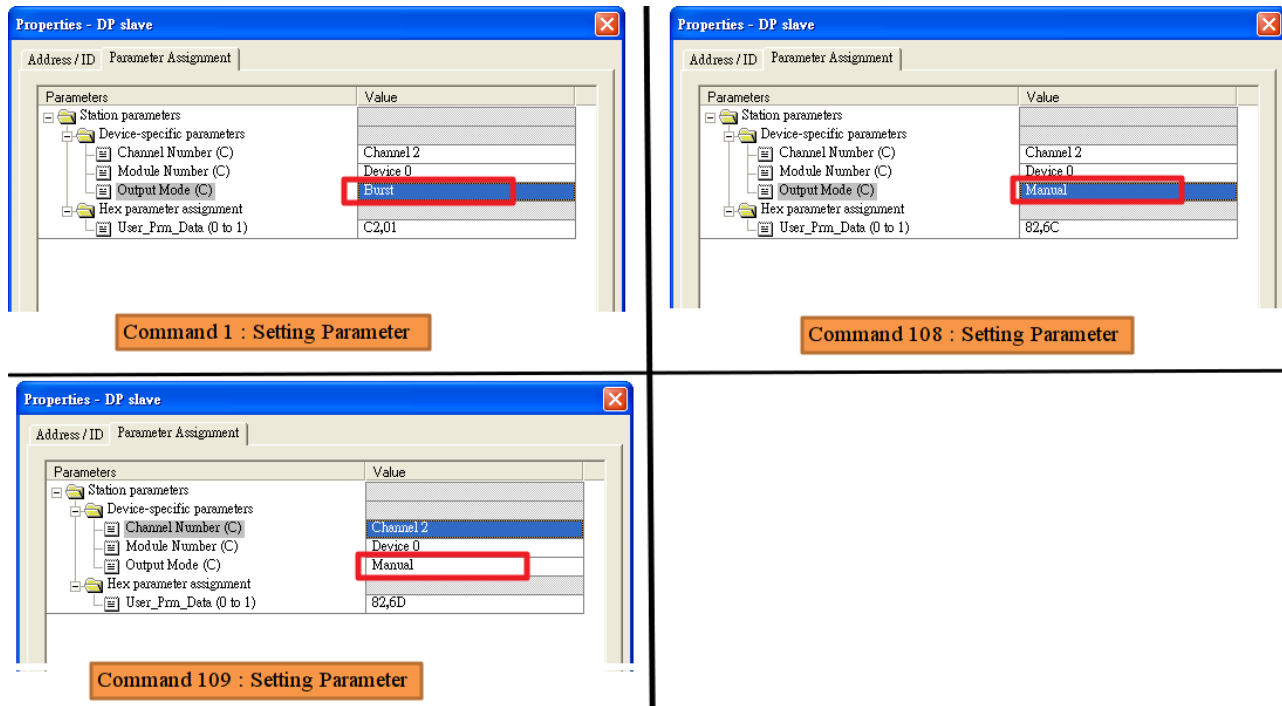



Figure 42 Set module parameters of Command 1 、 Command 108 、 Command 109 module

(2) Enable Burst mode

Click Monitor/Modify Variables in main windows to establish variable table 1 and fill in address of PROFIBUS output area. Input “1” at PQB0 、 input “3” at PQB2(module address of Command 108 module), and input “1 (command 1)” at PQB6 , then click  button to send command 108 to HART slave device for write burst mode command number. After send command 108, input “2” at PQB0 、 input ”4” at PQB2 (module address of Command 109 module), and input “1” at PQB7, then click  button to send command 109 to HART slave device for enable burst mode (Please refer to section 4.6.2), as shown in *Figure 43* 、 *Figure 44* and *Figure 45*.

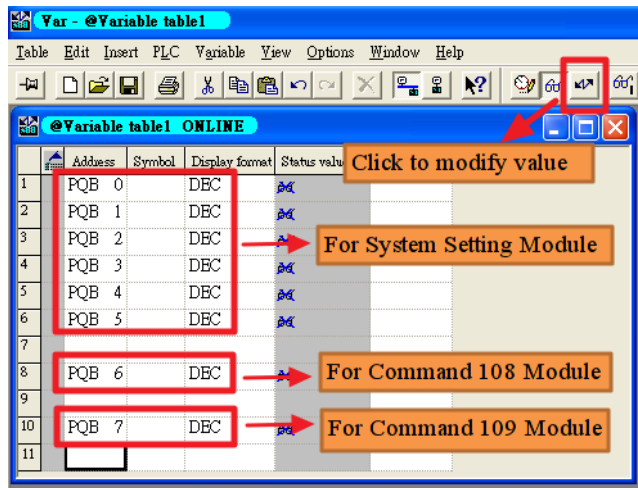

Figure 43 fill in address of PROFIBUS output area

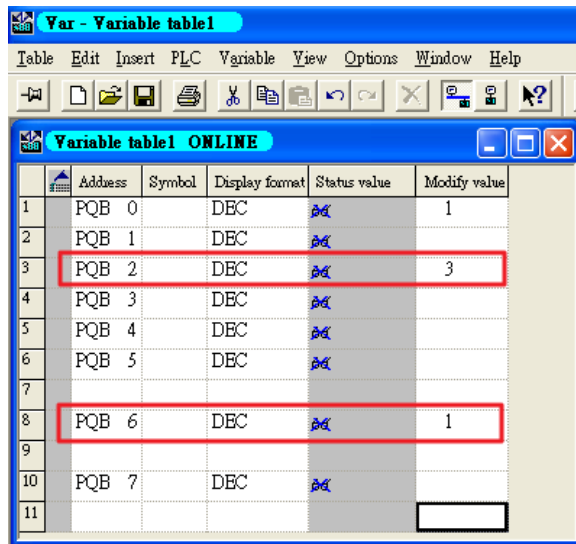

Figure 44 Send Command 108

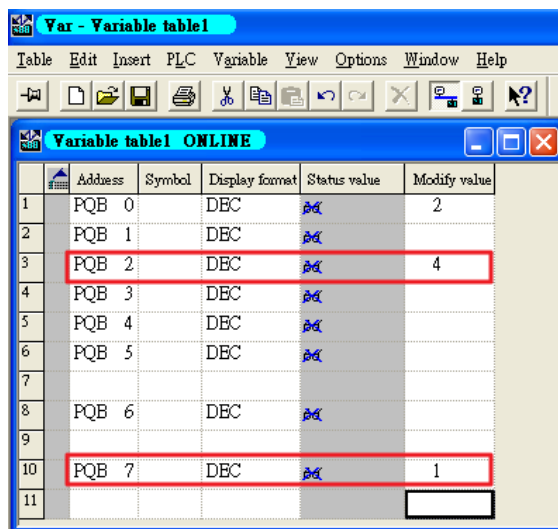

Figure 45 Send Command 109

(3) Receive Burst frame

Establish variable table 2 and fill in address of PROFIBUS input area. The value PIW4 increase in order and the value of PIB13 ~ PIB19 always change. It means GW-7557 receives burst frame of command 1 from HART slave continuously, as shown in *Figure 46* and *Figure 47*.

	Address	Symbol	Display format	Status value	Modify value
1	PIW 0	DEC			
2	PIW 2	DEC		0	
3	PIW 4	DEC		0	
4	PIW 6	DEC		0	
5	PIW 8	DEC			
6	PIB 10	DEC		0	
7	PIB 11	DEC		0	
8	PIB 12	DEC		0	
9					
10	PIB 13	HEX		B#16#00	
11	PIB 14	HEX		B#16#00	
12	PIB 15	HEX		B#16#00	
13	PIB 16	HEX		B#16#00	
14	PIB 17	HEX		B#16#00	
15	PIB 18	HEX		B#16#00	
16	PIB 19	HEX		B#16#00	
17					
18	PID 16	FLOATING_POINT		0.0	
19					
20	PIB 20	HEX		B#16#00	
21	PIB 21	HEX		B#16#00	
22	PIB 22	HEX		B#16#00	
23					
24	PIB 23	HEX		B#16#00	
25	PIB 24	HEX		B#16#00	
26	PIB 25	HEX		B#16#00	

Figure 46 fill in address of PROFIBUS input area

	Address	Symbol	Display format	Status value	Modify value
1	PIW 0		DEC	2	
2	PIW 2		DEC	2	
3	PIW 4		DEC	387	
4	PIW 6		DEC	0	
5	PIW 8		DEC	0	
6	PIB 10		DEC	2	
7	PIB 11		DEC	15	
8	PIB 12		DEC	0	
9					
10	PIB 13		HEX	B#16#00	
11	PIB 14		HEX	B#16#50	
12	PIB 15		HEX	B#16#0C	
13	PIB 16		HEX	B#16#3E	
14	PIB 17		HEX	B#16#C8	
15	PIB 18		HEX	B#16#89	
16	PIB 19		HEX	B#16#74	
17					
18	PID 16		FLOATING_POINT	0.3916737	
19					
20	PIB 20		HEX	B#16#00	
21	PIB 21		HEX	B#16#50	
22	PIB 22		HEX	B#16#01	
23					
24	PIB 23		HEX	B#16#00	
25	PIB 24		HEX	B#16#50	
26	PIB 25		HEX	B#16#01	

Figure 47 Receive burst frame of command 1

(4) Disable Burst mode

In variable table 1, input “3” at PQB0、input “4” at PQB2 (module address of Command 109 module) and input “0” at PQB7, then click  button to send command 109 to HART slave device for disable burst mode, as shown in Figure 48.

	Address	Symbol	Display format	Status value	Modify value
1	PQB 0		DEC	3	3
2	PQB 1		DEC	3	
3	PQB 2		DEC	3	4
4	PQB 3		DEC	3	
5	PQB 4		DEC	3	
6	PQB 5		DEC	3	
7					
8	PQB 6		DEC	3	
9					
10	PQB 7		DEC	3	0
11					

Figure 48 Send command 109 to disable burst mode

Note:

- GW-7557 just supports only one HART slave device in burst mode.
- command 108 : Write burst mode command number
- command 109 : Burst mode control
 - 1 => enable burst mode
 - 0 => disable burst mode
- Output Mode of Command 108 module and Command 109 module set to “Manual”, because command 108 and command 109 don’t need send to HART slave device continuously.
- Output Mode of Command 1 module set to “Burst”, because PROFIBUS need to allocates memory space to save burst frame of command 1.

5. Application of Utility

5.1 Install Utility

5.1.1 Install .Net Compact Framework :

It needs the runtime environment with .NET Framework 4.0 or above to execute the utility in the PC. If there has .NET Framework 4.0 or above in the PC, the section 5.1 can be omitted.

◆ Microsoft .Net Framework Version 4.0

<http://www.microsoft.com/download/en/details.aspx?id=17718>

5.1.2 Setup steps :

Step 1 :

Download the PROFIBUS/HART gateway utility setup file from the CD-ROM disk following the path of “CD:\profibus\gateway\gw-7557\utilities\PH_Tool\” or the web site

“ftp://ftp.icpdas.com.tw/pub/cd/fieldbus_cd/profibus/gateway/gw-7557/utilities/ph_tool/”

Step 2 :

Execute the Setup.exe file to install the PROFIBUS/HART Gateway Utility.

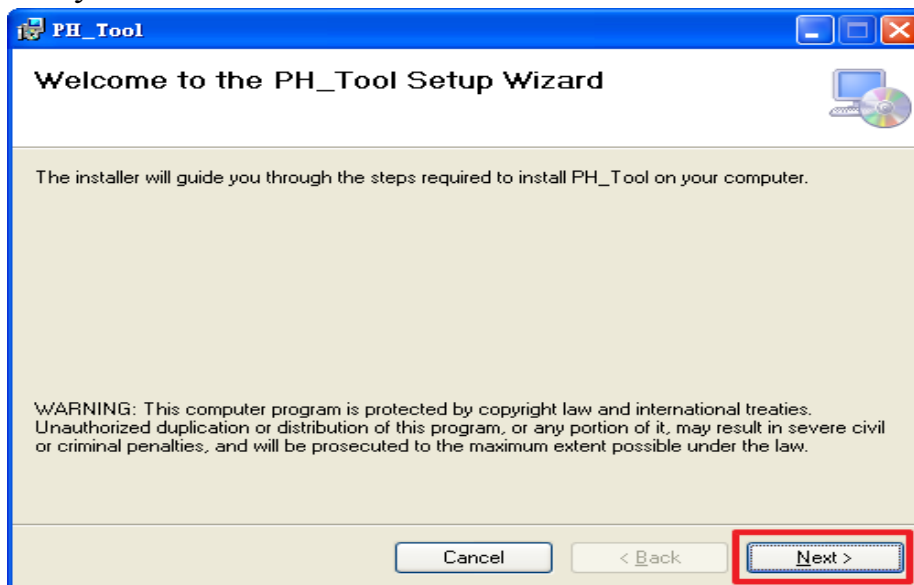

Figure 49 Install the utility

Step 3 :

Click the “Next” button to continue. If you want to change the installation destination, click “Browse” button to set the installation path.

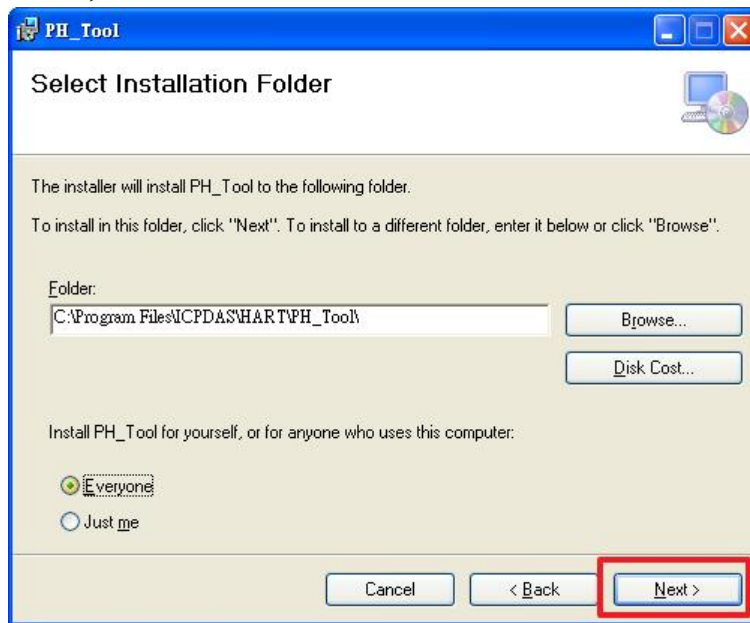

Figure 50 Set the installation path

Step 4 :

Click the “Next” button to confirm installation

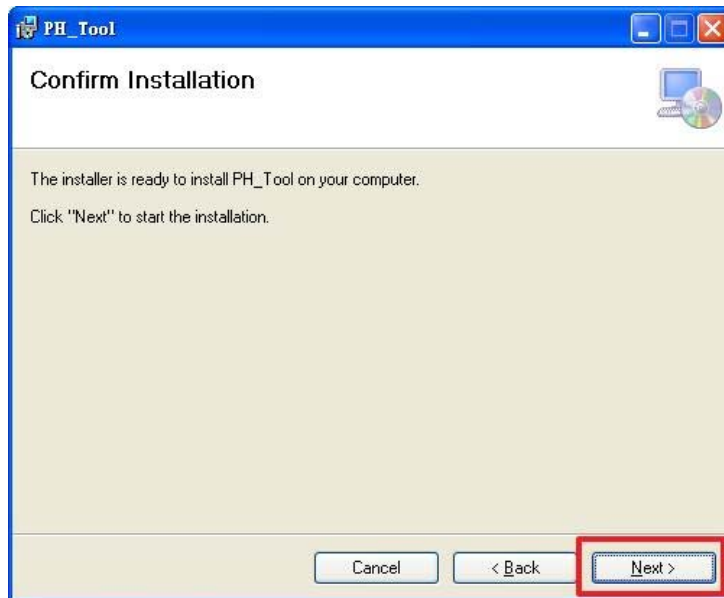

Figure 51 Confirm installation

Step 5 :

Click the “Close” button to finish and exit the installation program

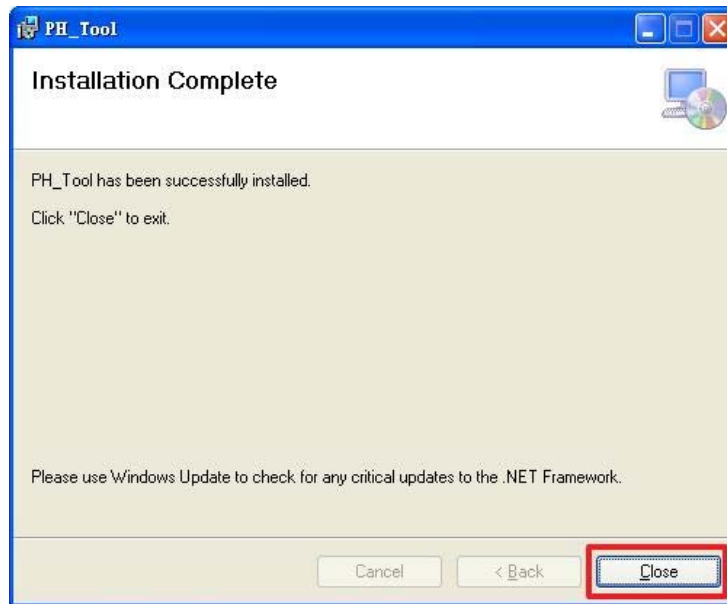

Figure 52 Installation complete

Step 6 :

After finishing the installation of the PROFIBUS/HART Gateway Utility, users can find the Utility as shown in the following screen shot.



Figure 53 The path of Utility

5.2 Utility introduction

It introduces main window of the utility first, as shown in *Figure 54*.

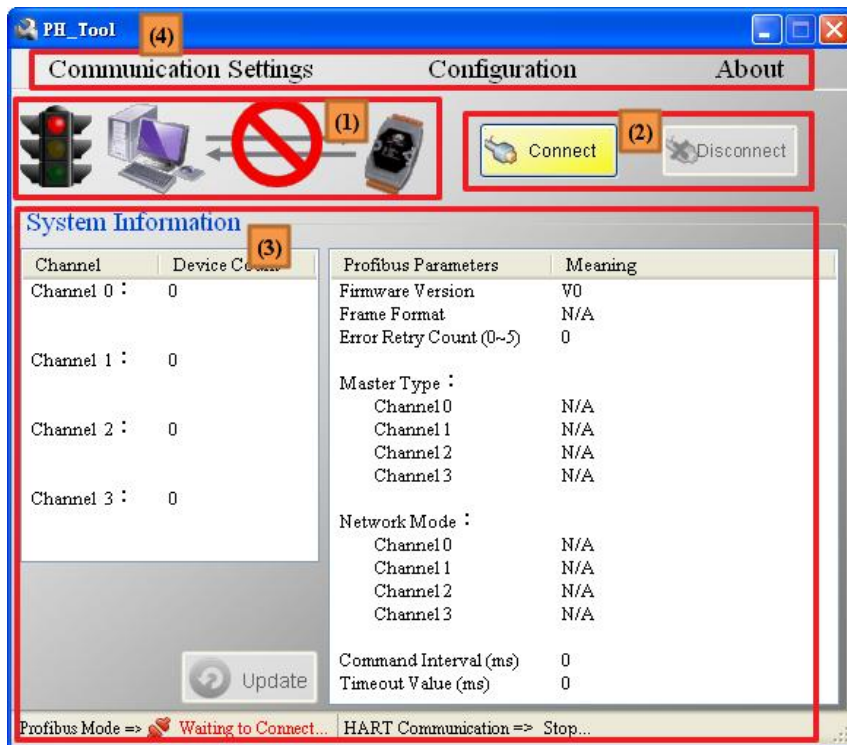







Figure 54 Main window of the utility

Main window of the utility has 4 parts, they are (1)Connection status 、 (2)Connection control 、 (3)System information 、 and (4)Tools, as shown in the below.

5.2.1 Connection status :

-  => It means the com port of PC has not been opened yet.
-  => 1. It means the com port of PC is open and PROFIBUS is in Offline state.
2. It means the com port of PC is open and trying to connect with the GW-7557
-  => It means the PC connects with the GW-7557 successfully and PROFIBUS is in Operate state.
-  => It means the com port of PC has not been opened yet.

- 
 => 1. It means the com port of PC is open and PROFIBUS is in Offline state.
 2. It means the com port of PC is open and trying to connect with the GW-7557.
- 
 => It means the PC connects with the GW-7557 successfully and PROFIBUS is in Operate state.

5.2.2 Connection control :

1. Connect button :

When the user clicks this button, the PC will open the com port and try to connect the GW-7557 module.

2. Disconnect button :

When the user clicks this button, the PC will break the connection of the GW-7557 and close the com port.

5.2.3 System information :

System information has 5 parts, they are (1) Device count of each HART channel 、 (2) common parameters of PROFIBUS 、 (3) PROFIBUS communication state 、 (4) HART communication state 、 and (5) update button, as shown in *Figure 55*

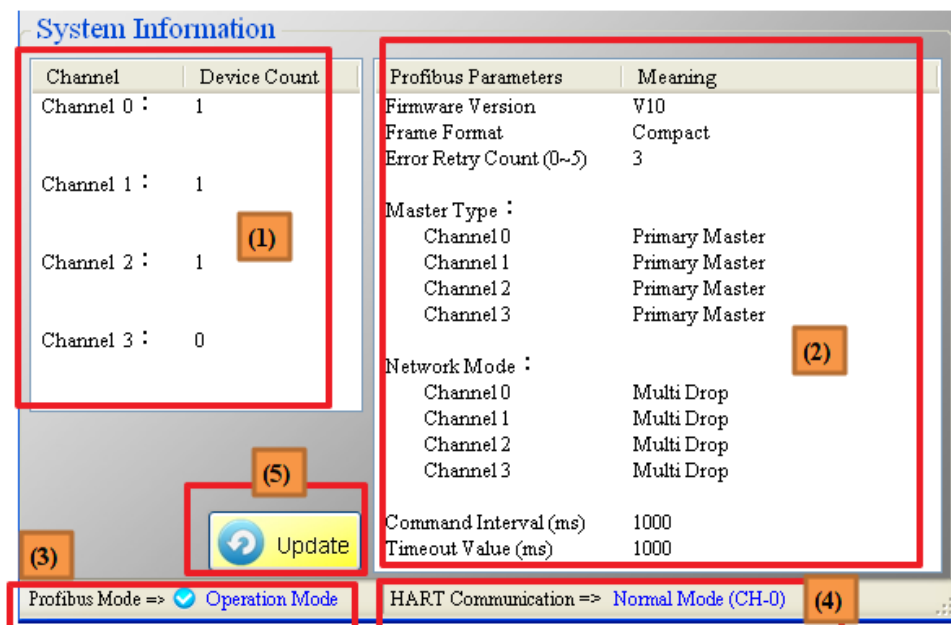

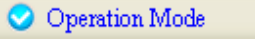

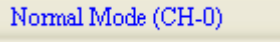
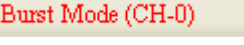
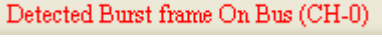

Figure 55 System information

- (1) Device count of each HART channel
If HART Frame Format is “Compact”, utility will read the module configuration of GW-7557 and show device count of each HART channel. Otherwise, if HART Frame Format is “Transparent”, device count always set to zero.
- (2) common parameters of PROFIBUS
When the PC connects with the GW-7557 successfully and PROFIBUS is in Operate state, utility will show common parameters of PROFIBUS.
- (3) PROFIBUS communication state
 - (1)  : It means connect button has not been clicked yet.
 - (2)  : It means PROFIBUS is in Offline state. In this state, utility doesn't support Device Configuration(Please refer to section 5.2.4.2).
 - (3)  : It means PROFIBUS is in Operate state. In this state, utility support Device Configuration(Please refer to section 5.2.4.2).
- (4) HART communication state
 - (1)  : GW-7557 has not communicate with HART slave device yet.
 - (2)  : GW-7557 communicates with HART slave device from HART channel 0.
 - (3)  : GW-7557 communicates with HART slave device from HART channel 0 and HART slave device is in burst mode.
 - (4)  : GW-7557 detects burst frame on HART channel 0, and GW-7557 doesn't set burst module in channel 0.
- (5) update button
When user click update button, utility will read system information and module configuration from GW-7557 immediately.

5.2.4 Tools :

Tools have 4 parts, they are(1) Communication Settings 、(2) Device Configuration 、(3) Import Project File 、and (4) About, as shown in *Figure 56*.

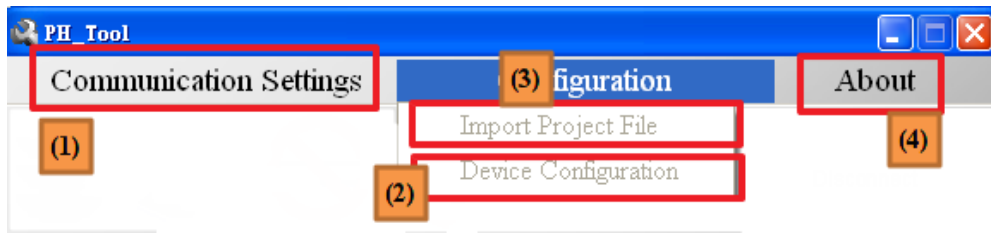

Figure 56 Tools

5.2.4.1 Communication Settings :

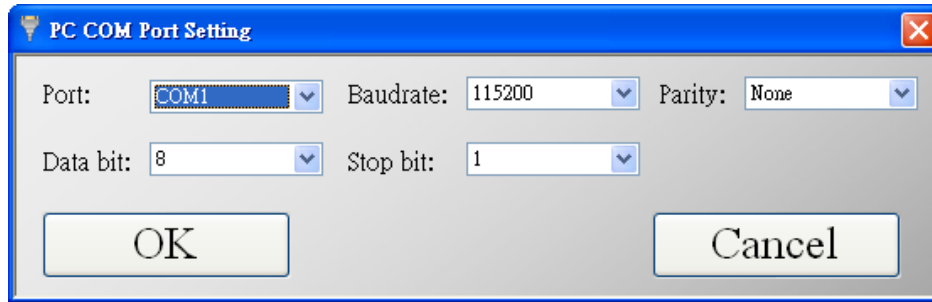

Figure 57 Communication Settings window

The user can set communication settings of PC com port by this window. These settings have to be the same with the GW-7557, or else the connection will be failed.

Port: Com 1~ Com 8
 Baudrate: 2400~115200 bps
 Parity: None/Odd/Even
 Data Bits: 7/8 bits
 Stop Bits: 1/2 bits

5.2.4.2 Device Configuration :

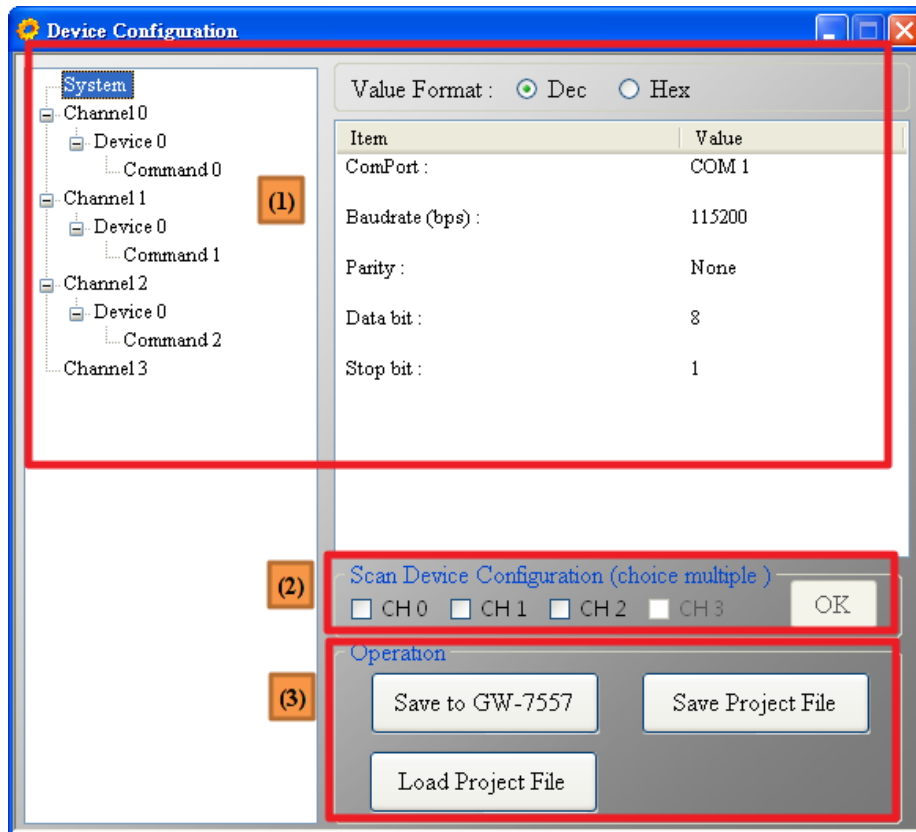

Figure 58 Device Configuration window

In this window, it will show the configuration of the GW-7557 module. The user can setup the configuration of the GW-7557 module here. This window has 3 parts, they are (1) The node information, (2) Scan Device Configuration, and (3) Operation buttons, as shown in Figure 58.

(1) The node information

When the user selects the node at the left side of window, it will show the node information at the right side of window. “Value Format” supports the decimal representation or the hexadecimal representation. About the information of these nodes is shown in Table 11.

Table 11 The node information

Node	Behavior	Information
System	Click	Baudrate(bps) : 2400~115200 Parity : None/Odd/Even Data bit : 7/8 Stop bit : 1/2

	Right click	<p>It will pop a menu, the menu include “Edit GW-7557 COM Port”.</p> <p>Edit GW-7557 COM Port : The user can set communication settings of GW-7557 com port by this window.</p>
Channel	Click	<p>Master Type : Primary Master/ Secondary Master Network Type : Point to Point/Multi Drop Device Count : 1~16</p>
Device	Click	<p>Preamble Length(5~20) : 5~20 Frame Type(Short/Long) : Short/Long Manufacturer ID : 1 byte Device Type : 1 byte Device ID : 3 byte</p>
	Right click	<p>It will pop a menu, the menu include “Edit Device”、”Save to File”、”Load from File” and ”Device Test”.</p> <p>Edit Device : The user can edit HART slave device settings by this window.</p> <p>Save to File : The user can save single HART slave device settings to a file (*.info).</p> <p>Load from File : The user can load single HART slave device settings from a file (*.info).</p> <p>Device Test : The user can test communication between GW-7557 and this HART slave device.</p>
Command	Click	<p>Output Mode : Initial/Polling/Manual/Burst Output Length(byte) : 0~24 Input Length(byte) : 0~27 Profibus Output Address Profibus Input Address</p>

A. About “Edit GW-7557 COM” :

The user can set communication settings of GW-7557 com port in this window, as shown in *Figure 59*. When user click <Save to Device> button, these settings will be save to EEPROM of GW-7557.

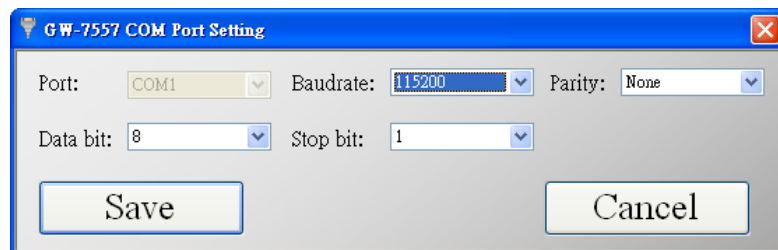

Figure 59 “Edit GW-7557 COM” window

B. About “Edit Device”

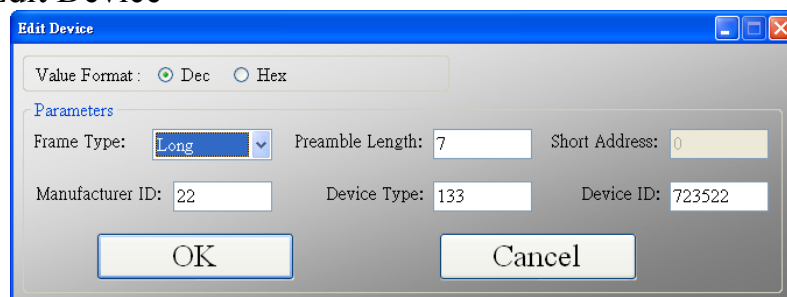

Figure 60 “Edit Device” window

- Value Format : Support the decimal representation or the hexadecimal representation.
- Frame Type : The user can set the frame type for HART slave device. The option is Short/Long.
- Preamble Length : The user can set the preambles for HART slave device. The range is 5~20.
- Short Address : The user can set the address for HART slave device. The range is 0~15. If the frame type is “Long”, the user can omits this setting.
- Manufacturer ID : The user can set the manufacturer ID for HART slave device. If the frame type is “Short”, the user can omits this setting.
- Device Type : The user can set the device type for HART slave device. If the frame type is “Short”, the user can omits this setting.
- Device ID : The user can set the device ID for HART slave device. If the frame type is “Short”, the user can omits this setting.

C. About “Save to File”

The user can click “Save to File” to open a save file dialog to save single HART slave device settings to a file (*.info) for backup, as shown in *Figure 61*.

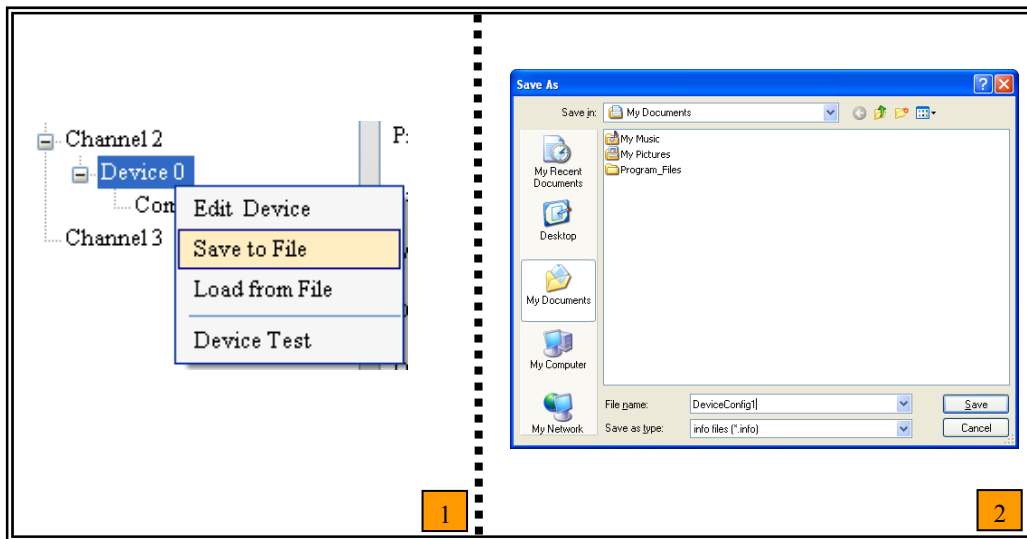

Figure 61 “Save to File”

D. About “Load from File”

The user can click “Load from File” to open a load file dialog to load single HART slave device settings from a file (*.info) for backup, as shown in *Figure 62*.

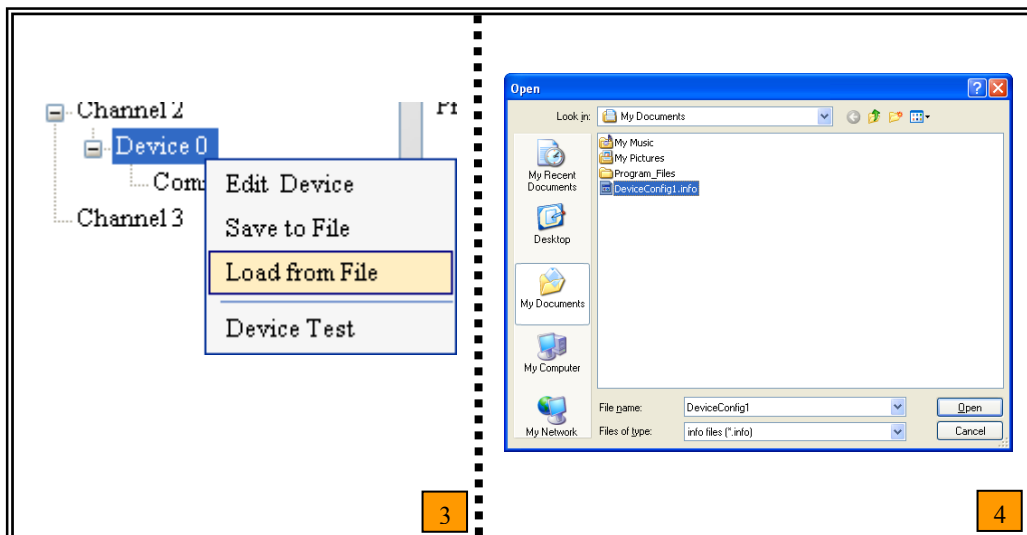

Figure 62 “Load from File”

E. About “Device Test”

The user can click “Device Test” to test communication between GW-7557 and HART slave device, as shown in *Figure 63*.

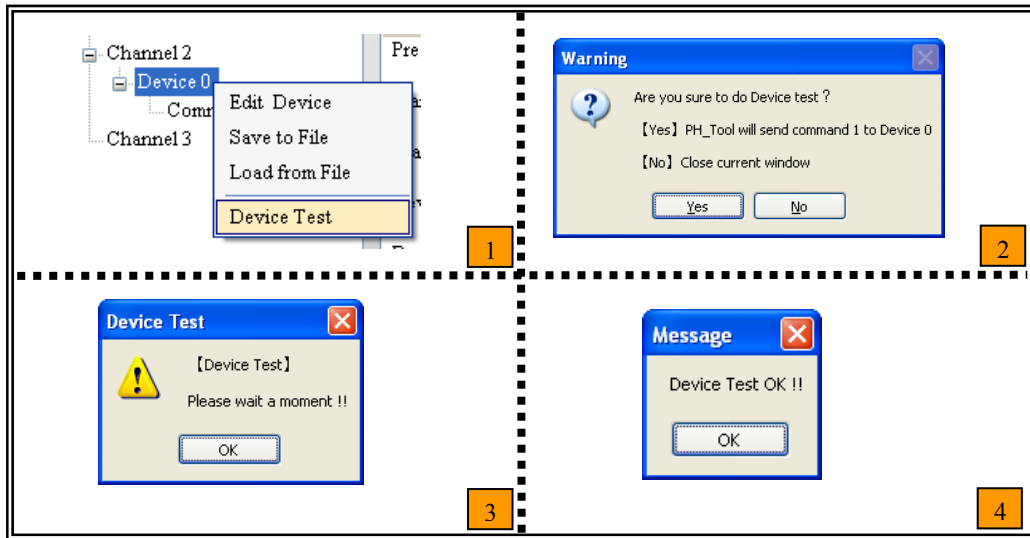

Figure 63 “Device Test”

(2) Scan Device Configuration

If the user enables this function, the system will detect HART frame type, address, preamble length, manufacturer ID, device type and device ID automatically, as shown in *Figure 64*.

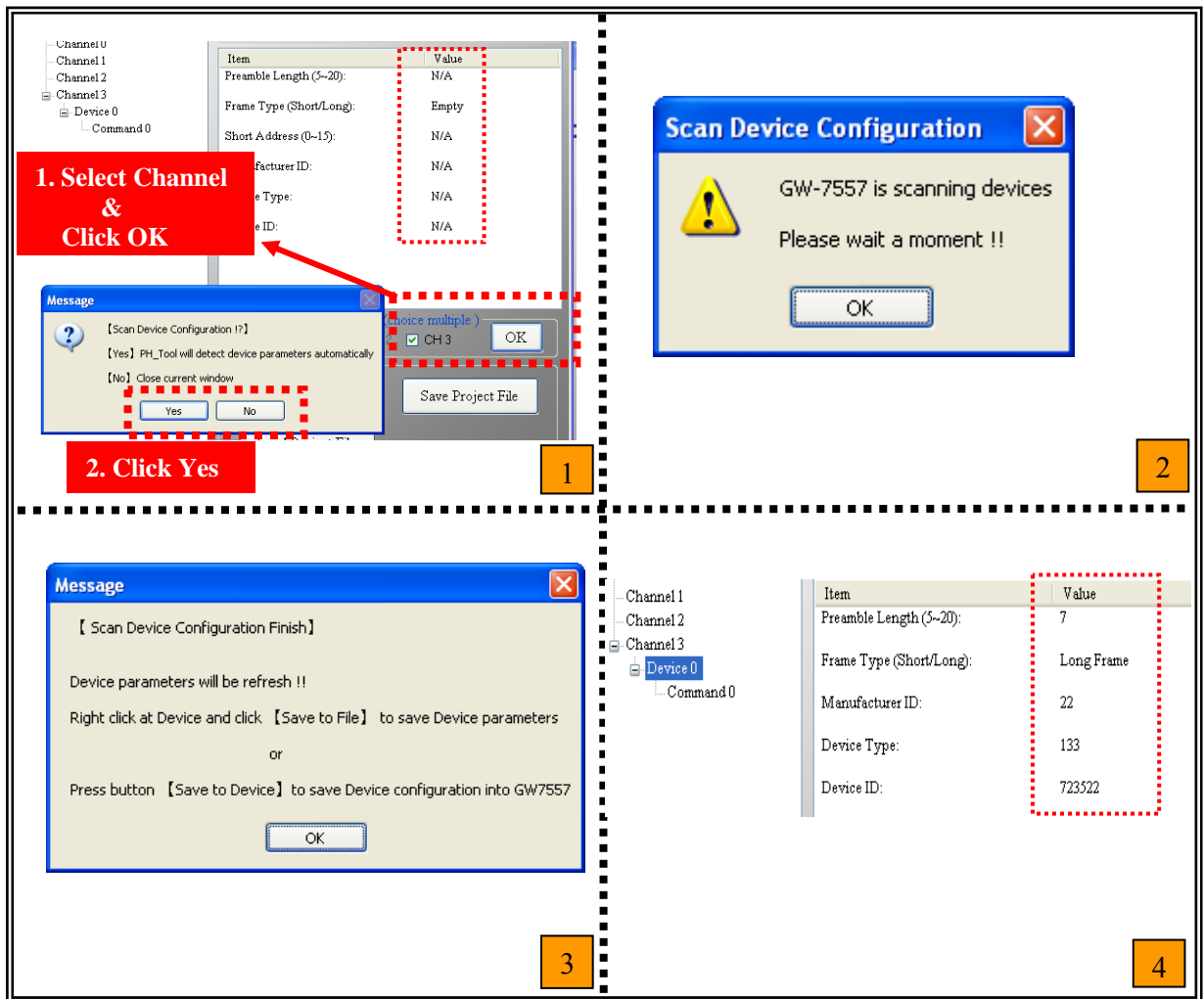

Figure 64 “Scan Device Configuration”

Note :

Before the user enables this function, the user must confirm that there is only one HART slave device in each HART channel, or else this function will be failed.

(3) Operation buttons

Operation buttons have 3 parts, they are (1) Save to GW-7557 、 (2) Save Project File 、 and (3) Load Project File, as shown in Figure 65.

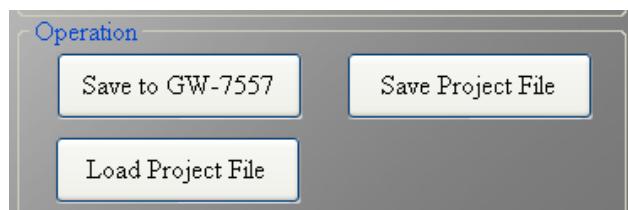

Figure 65 “Operation buttons”

A. Save to GW-7557 :

The user can click “Save to GW-7557” button, then all HART slave device configuration will save to EEPROM of GW-7557.

B. Save Project File :

The user can click “Save Project File” button to open a save dialog to save all HART slave device configurations to a file (*.pj) for backup.

C. Load Project File :

The user can click “Load Project File” button to open a load dialog to load all HART slave device configurations from a file (*.pj) for backup.

5.2.4.3 Import Project File :

This function is the combination of “Load Project File” and “Save to GW-7557”, and the user can use this function even PROFIBUS is Offline state. When the user click “Import Project File”, this function will open a load file dialog to load project file (*.pj) and save settings of project file to EEPROM of GW-7557, as shown in *Figure 66*.

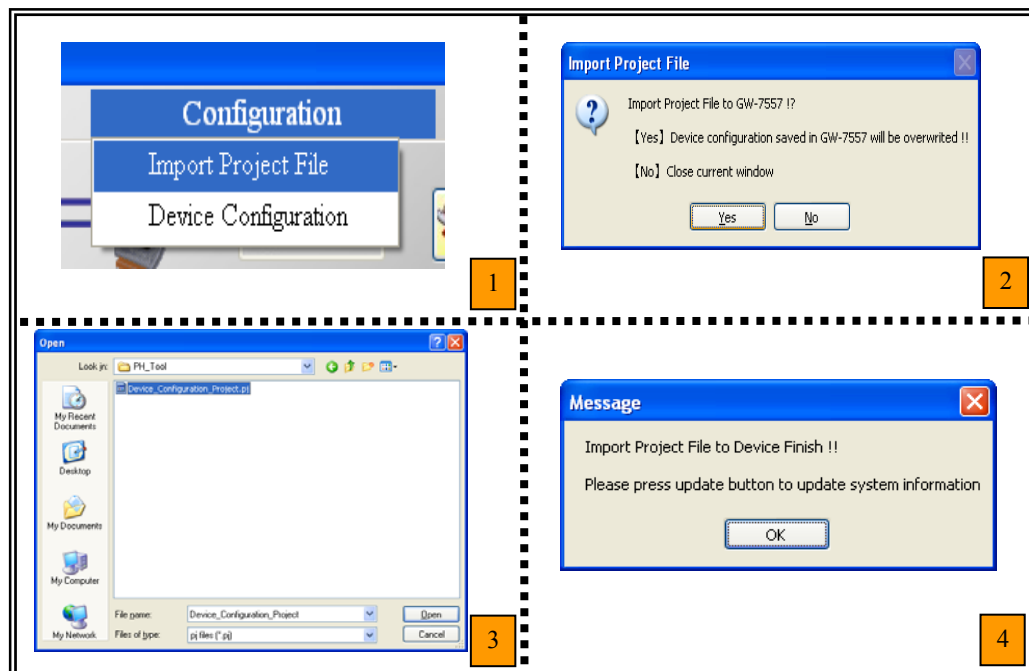

Figure 66 “Import Project File”

5.2.4.4 About :

The utility version will show in this window, as shown in *Figure 67*.



Figure 67 “About” window

5.3 Establish connection with GW-7557

The connection of Utility and GW-7557 is shown in *Figure 68*. Please follow the steps to establish connection.

Step 1:

Wire COM Port of PC to RS-232 port of GW-7557.

Step 2:

Connect PROFIBUS cable between PROFIBUS Master station and GW-7557 and enter data exchange mode (please refer step 1~7 of section 4.9 for detail). The RUN LED of GW-7557 is going to light at this time.

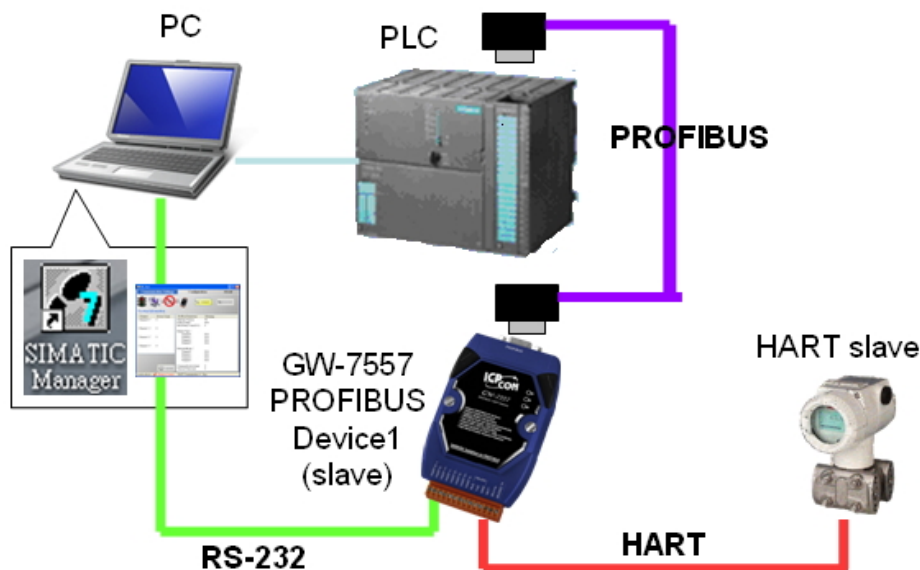

Figure 68 The connection of Utility and GW-7557

Step 3:

Set COM Port communication settings of utility the same as COM Port settings of GW-7557 or turn the switch on the back of the GW-7557 to use default settings (please refer section 2.6).

About default settings are shown in the below:

Baudrate : 115200 bps

Data bit : 8 bits

Stop bit : 1 bit

Parity : None

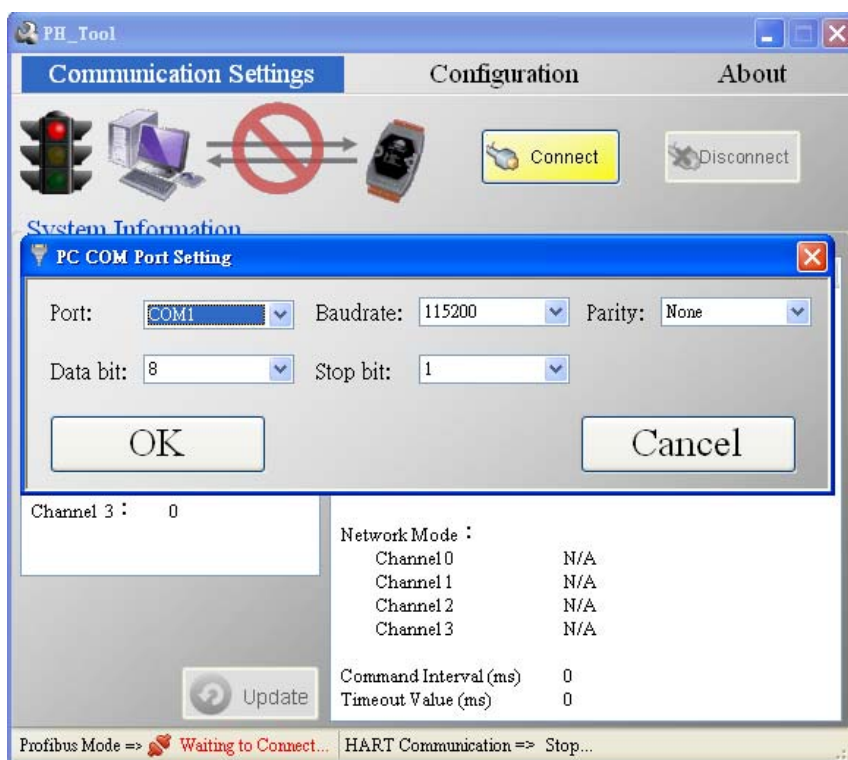

Figure 69 COM port settings of utility

Step 4:

Click “Connect” button

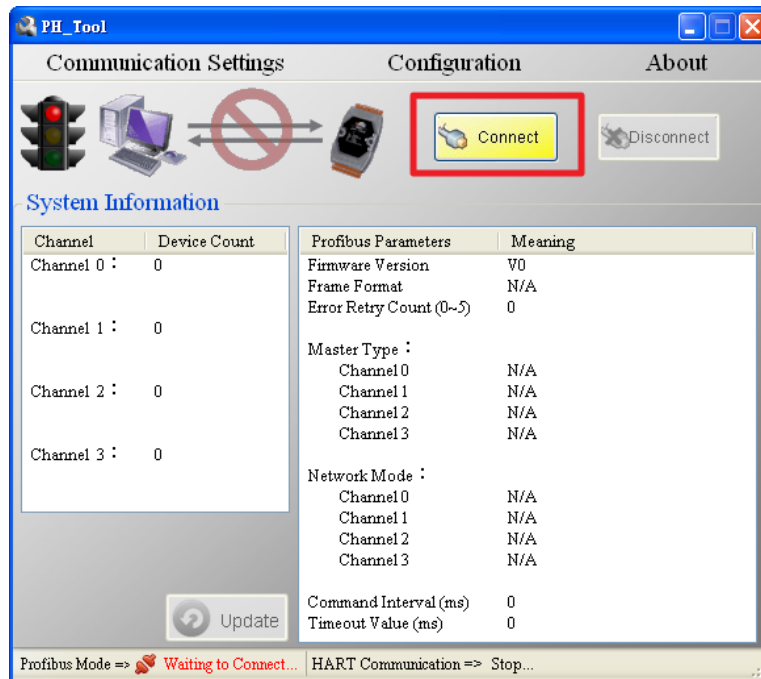

Figure 70 Click “Connect ” button

Step 5:

Traffic light shows green in the utility now; it means the connection is successful.

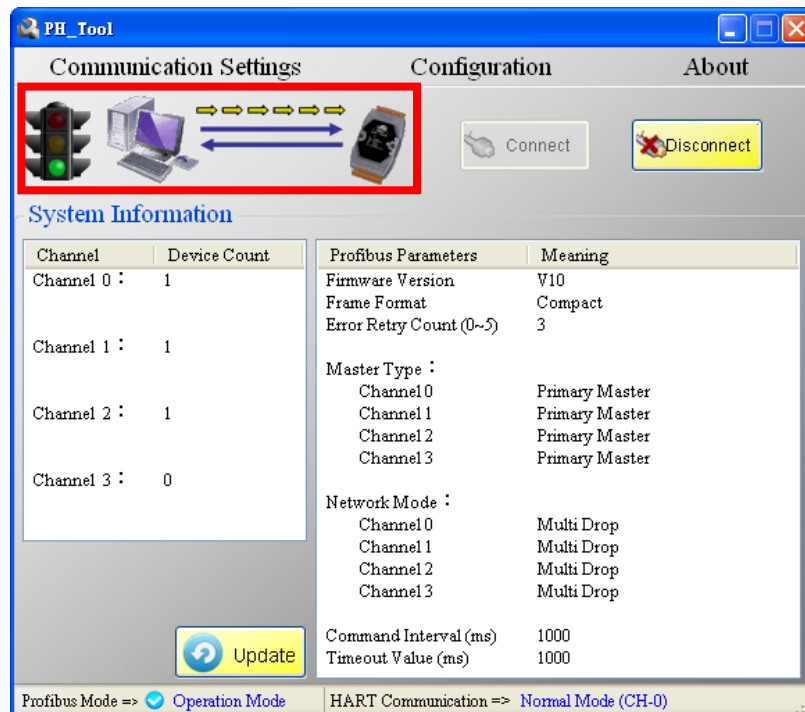

Figure 71 Connection status

6. Troubleshooting

The troubleshooting list can help users to resolve the problems when using the GW-7557. If the problem still can't be solved, please contact with technical staff of ICP DAS.

Table 12 Errors and solutions

Item	Trouble state	Solution
1	'PWR' LED indication of the GW-7557 is always turned off	The power supply of GW-7557 has some problems. Please check the wire connection of the power and the voltage is between 10~30V _{DC} .
2	'ERR' LED indication of the GW-7557 is always turned on	That means the GW-7557 isn't connecting to the PROFIBUS Master station. Please check the wire connection and the PROFIBUS Master station. The configuration and address of GW-7557 in the PROFIBUS Master station are not correct.
3	'ERR' LED indication of the GW-7557 is flashing fast	It means the GW-7557 connects with Utility.
4	'ERR' LED indication of the GW-7557 is flashing slow	It means the GW-7557 has diagnostic messages. Please check diagnostic messages in the PROFIBUS Master station.
5	PROFIBUS Master station can not communicate with the HART slave device, when "RUN LED" of the GW-7557 is light and "ERR LED" of the GW-7557 is dark.	<ol style="list-style-type: none"> Please confirm the GW-7557 doesn't clear diagnostic message by communication command (please refer to section 4.6.2). Please confirm the connection between the GW-7557 and Modbus device. If HART Frame Format is "Transparent", please confirm the output data put in correct address and have changed value of byte 0 to trigger this command, when output data can not send to HART slave device in output data area of PROFIBUS Master. If HART Frame Format is "Compact", please confirm module parameters of HART Command module are correct. The user can also use "Scan Device Configuration" function and "Device Test" function of utility to test communication between GW-7557 and HART slave device.

7. Dimensions

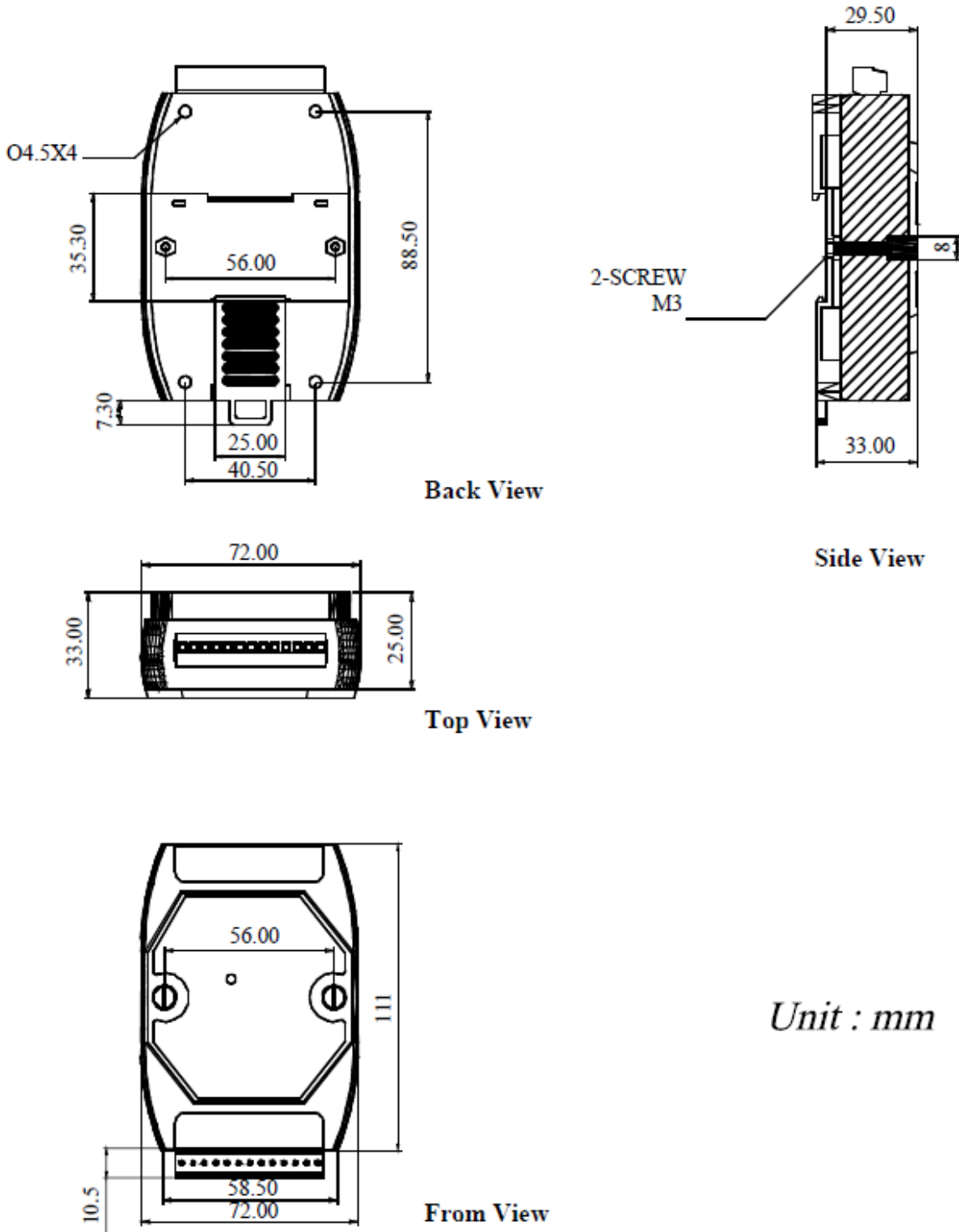

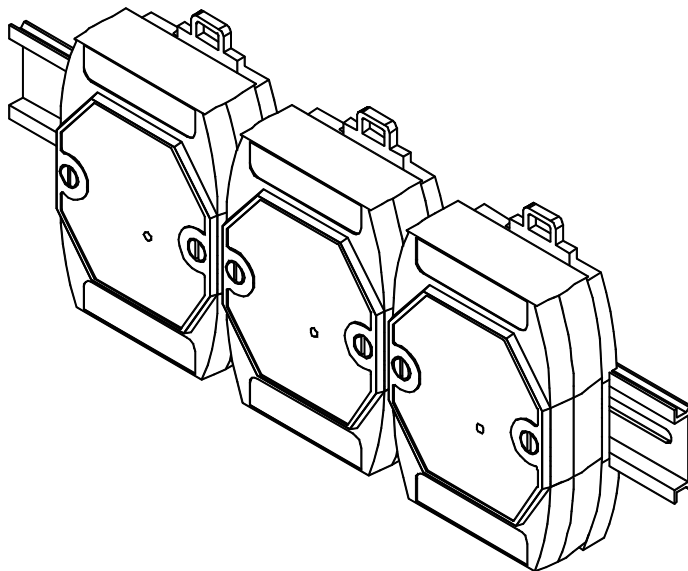
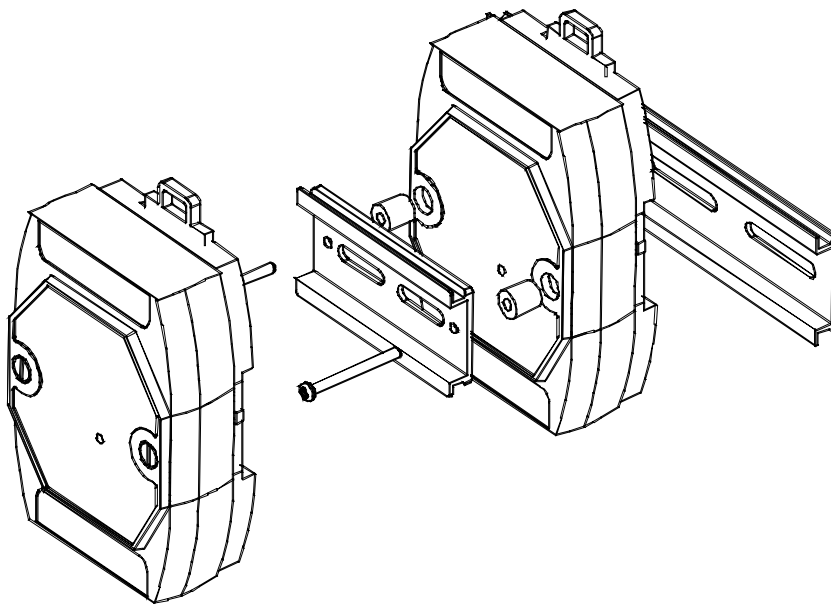

Appendix A. HART Command

We extracted parts of the HART universal command here.

Command 0: Read Unique Identifier

Request data bytes: none

Response data bytes: $2+12 = 14$

Index format description

Byte 0: uint8 Response code 1

Byte 1: uint8 Response code 2

Byte 2: uint8 254

Byte 3: uint8 Manufacturer ID

Byte 4: uint8 Manufacturer's device ID

Byte 5: uint8 Number of preambles needed in the request

Byte 6: uint8 Command set revision number

Byte 7: uint8 Transmitter specific revision code

Byte 8: uint8 Software revision

Byte 9: uint8 Hardware revision

Byte 10: uint8 Flags

Byte 11~13: uint24 Device ID number (MSB first)

Command 1: Read Primary Variable

Request data bytes: none

Response data bytes: $2+5 = 7$

Index format description

Byte 0: uint8 Response code 1

Byte 1: uint8 Response code 2

Byte 2: uint8 Unit code

Byte 3~6: float Primary Variable

Command 2: Read P.V. Current and Percentage of Range

Request data bytes: none

Response data bytes: $2+8 = 10$

Index format description

Byte 0: uint8 Response code 1

Byte 1: uint8 Response code 2

Byte 2~5: float Primary Variable Current

Byte 6~9: float Primary Variable Percentage of Range

Command 3: Read Dynamic Variables and P.V. Current

Request data bytes: none

Response data bytes: $2+24 = 26$

Index format description

Byte 0: uint8 Response code 1

Byte 1: uint8 Response code 2

Byte 2~5: float Primary Variable Current

Byte 6: uint8 Primary Variable Unit code

Byte 7~10: float Primary Variable

Byte 11: uint8 Secondary Variable Unit code

Byte 12~15: float Secondary Variable

Byte 16: uint8 Tertiary Variable Unit code

Byte 17~20: float Tertiary Variable

Byte 21: uint8 4th Variable Unit code

Byte 22~25: float 4th Variable

Command 6: Write Polling Address

Request data bytes: 1

Index format description

Byte 0: uint8 Polling Address

Response data bytes: $2+1 = 3$

Index format description

Byte 0: uint8 Response code 1

Byte 1: uint8 Response code 2

Byte 2: uint8 Polling Address

Command 11: Read Unique Identifier Associated with TAG

Request data bytes: 6

Index format description

Byte 0~5: PA6 TAG Name

Response data bytes: $2+12 = 14$

Index format description

Byte 0: uint8 Response code 1

Byte 1: uint8 Response code 2

Byte 2: uint8 254

Byte 3: uint8 Manufacturer ID

Byte 4: uint8 Manufacturer's device ID
Byte 5: uint8 Number of preambles needed in the request
Byte 6: uint8 Command set revision number
Byte 7: uint8 Transmitter specific revision code
Byte 8: uint8 Software revision
Byte 9: uint8 Hardware revision
Byte 10: uint8 Flags
Byte 11~13: uint24 Device ID number (MSB first)

Command 12: Read Message

Request data bytes: none

Response data bytes: $2+24 = 26$
Index format description
Byte 0: uint8 Response code 1
Byte 1: uint8 Response code 2
Byte 2~25: PA24 Message

Command 13: Read Tag, Descriptor, Date

Request data bytes: none

Response data bytes: $2+21 = 23$
Index format description
Byte 0: uint8 Response code 1
Byte 1: uint8 Response code 2
Byte 2~7: PA6 TAG Name
Byte 8~19: PA12 Descriptor
Byte 20: uint8 Day of month
Byte 21: uint8 Month of year
Byte 22: uint8 Year as offset to 1900

Command 14: Read Primary Variable Sensor Information

Request data bytes: none

Response data bytes: $2+16 = 18$
Index format description
Byte 0: uint8 Response code 1
Byte 1: uint8 Response code 2
Byte 2~4: uint24 Sensor Serial Number (MSB first)
Byte 5: uint8 Sensor limits unit
Byte 6~9: float Upper sensor limit

Byte 10~13: float Lower sensor limit

Byte 14~17: float Minimum span

Command 15: Read Primary Variable Output Information

Request data bytes: none

Response data bytes: $2+17 = 19$

Index format description

Byte 0: uint8 Response code 1

Byte 1: uint8 Response code 2

Byte 2: uint8 Alarm select code

Byte 3: uint8 Transfer function code

Byte 4: uint8 PV range value unit code

Byte 5~8: float Upper range value

Byte 9~12: float Lower range value

Byte 13~16: float Damping value

Byte 17: uint8 Write protect code

Byte 18: uint8 Private label distribution code

Command 16: Read Final Assembly Number

Request data bytes: none

Response data bytes: $2+3 = 5$

Index format description

Byte 0: uint8 Response code 1

Byte 1: uint8 Response code 2

Byte 2~4: uint24 Final assembly number (MSB first)

Command 17: Write Message

Request data bytes: 24

Index format description

Byte 0~23: PA24 Message

Response data bytes: $2+24 = 26$

Index format description

Byte 0: uint8 Response code 1

Byte 1: uint8 Response code 2

Byte 2~25: PA24 Message

Command 18: Write Tag, Descriptor, Date

Request data bytes: 21

Index format description

Byte 0~5: PA6 TAG Name

Byte 6~17: PA12 Descriptor

Byte 18: uint8 Day of month

Byte 19: uint8 Month of year

Byte 20: uint8 Year as offset to 1900

Response data bytes: $2+21 = 23$

Index format description

Byte 0: uint8 Response code 1

Byte 1: uint8 Response code 2

Byte 2~7: PA6 TAG Name

Byte 8~19: PA12 Descriptor

Byte 20: uint8 Day of month

Byte 21: uint8 Month of year

Byte 22: uint8 Year as offset to 1900

Command 19: Write Final Assembly Number

Request data bytes: 3

Index format description

Byte 0~2: uint24 Final assembly number (MSB first)

Response data bytes: $2+3 = 5$

Index format description

Byte 0: uint8 Response code 1

Byte 1: uint8 Response code 2

Byte 2~4: uint24 Final assembly number (MSB first)

Note:

Uint8: 8-bit unsigned integer

Uint24: 24-bit unsigned integer

Float: IEEE 754 format

PA6: Packed-ASCII 6 octets = 8 characters

PA12: Packed-ASCII 12 octets = 16 characters

PA24: Packed-ASCII 24 octets = 32 characters