



### VPD-173N

7" Touch HMI Device with 2 x RS-232/RS-485, Ethernet (PoE), 16 MB Flash

### VPD-173N-64

7" Touch HMI Device with 2 x RS-232/RS-485 and Ethernet (PoE), 64 MB Flash

### VPD-173X

7" Touch HMI Device with 2 x RS-232/RS-485, Ethernet (PoE), 16 MB Flash, Support XV-board

### VPD-173X-64

7" Touch HMI Device with 2 x RS-232/RS-485, Ethernet (PoE), 64 MB Flash, Support XV-board

### Features

- PoE (Power over Ethernet)
- RTC (Real Time Clock)
- Buzzer
- Free HMIWorks development tool
- Supports C programming language and Ladder Designer
- Supports the custom communication protocol (C language)
- Modbus TCP/RTU protocol
- Front Panel: IP65 Waterproof
- I/O Expansion Board: XV-board (VPD-173X/VPD-173X-64)
- Operating Temperature: -10 ~ 60 °C



### Introduction

The **TouchPAD VPD 7" Series** is a series of industrial touch HMI devices is designed for building, home and industrial automation. VPD-173 series HMI is equipped with high resolution TFT color touch screen and is seamlessly integrated with rich I/O modules and presents beautiful, flexible and user-defined picture frame. In short, it is the best choice to upgrade the mechanical switch to intelligent control pads.

HMIWorks is a free development software for the VPD series HMI devices, which provides Ladder Designer for PLC users, and C language environment for IT users. Especially, it only takes no more than 30 minutes to learn how to create an application program of VPD-series devices when using Ladder Designer.

### Appearance & Pin Assignments

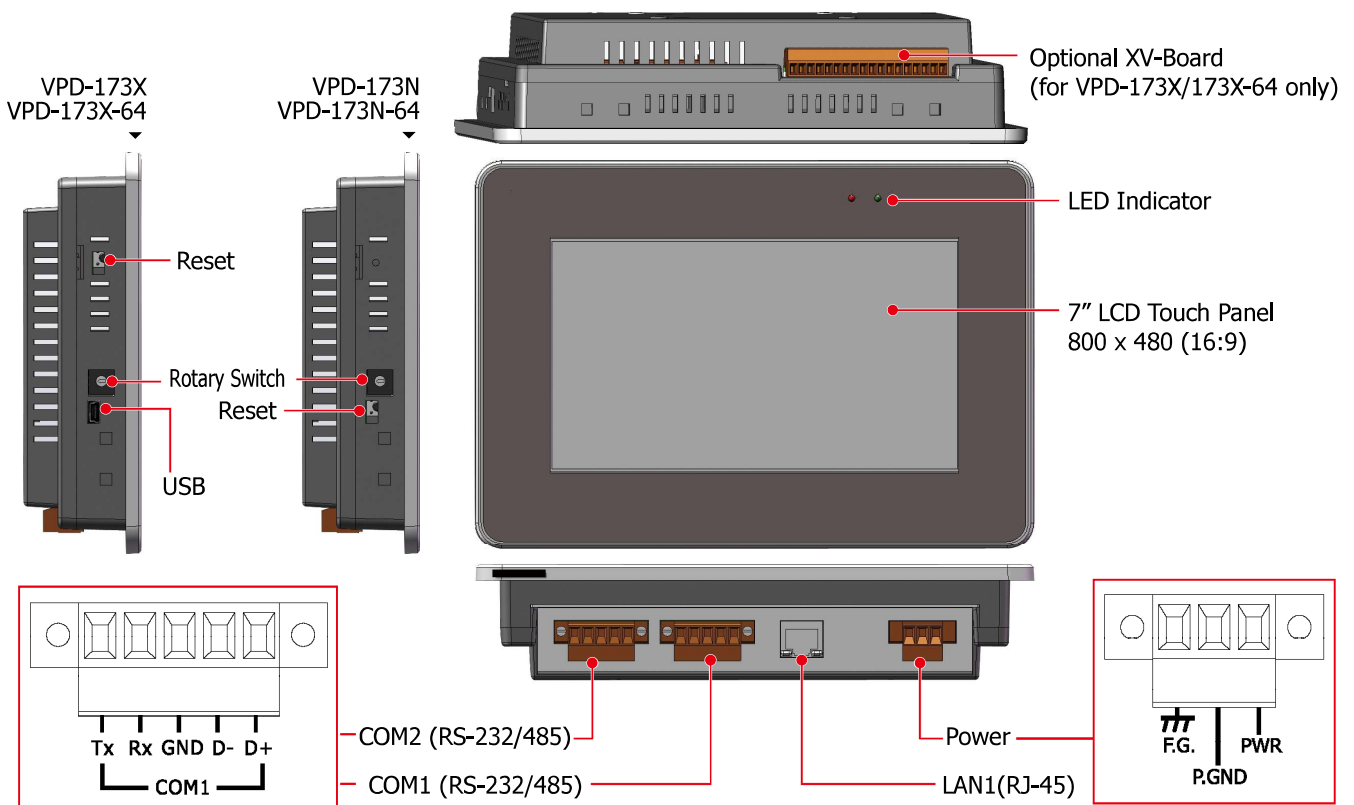

## Specifications

Model	VPD-173N	VPD-173N-64	VPD-173X	VPD-173X-64
<b>Main Unit</b>				
CPU	32-bit RISC CPU			
Storage	16 MB SDRAM/16 MB Flash	64 MB SDRAM/64 MB Flash	16 MB SDRAM/16 MB Flash	64 MB SDRAM/64 MB Flash
Real Time Clock	Yes			
<b>Display</b>				
Type	LCD 7" TFT (Resolution 800 x 480 , 65535 colors), defective pixels <= 3			
Backlight Life	20,000 hours			
Brightness	250 cd/m2	400 cd/m2	250 cd/m2	400 cd/m2
Touch Panel	Yes			
<b>LED Indicators</b>				
Status	2 LED			
<b>COM Ports</b>				
Ports	2 x RS-232 (3-pin) or RS-485 (including Self-Tuner) ; 2500 VDC isolated			
<b>HMI</b>				
Buzzer	Yes			
Rotary Switch	Yes			
Reset Button	Yes			
<b>Ethernet</b>				
Ports	RJ-45 x 1, 10/100 Base-TX			
<b>USB</b>				
Connector	-		Firmware updates only	
<b>Power</b>				
Consumption	3.6 W			
Powered from PoE	IEEE 802.3af, Class1 (48 V)			
Powered from Terminal Block	+12 ~ 48 VDC			
<b>Mechanical</b>				
Dimensions (mm)	217 mm x 153 mm x 33 mm			
Installation	Wall Mounting			
Ingress Protection Rating	Front Panel: NEMA 4 /IP65			
<b>Environmental</b>				
Operating Temperature	-10 ~ +60 °C			
Storage Temperature	-20 ~ +70 °C			
Humidity	10 ~ 90% RH, non-condensing			

## Dimensions (Units: mm)

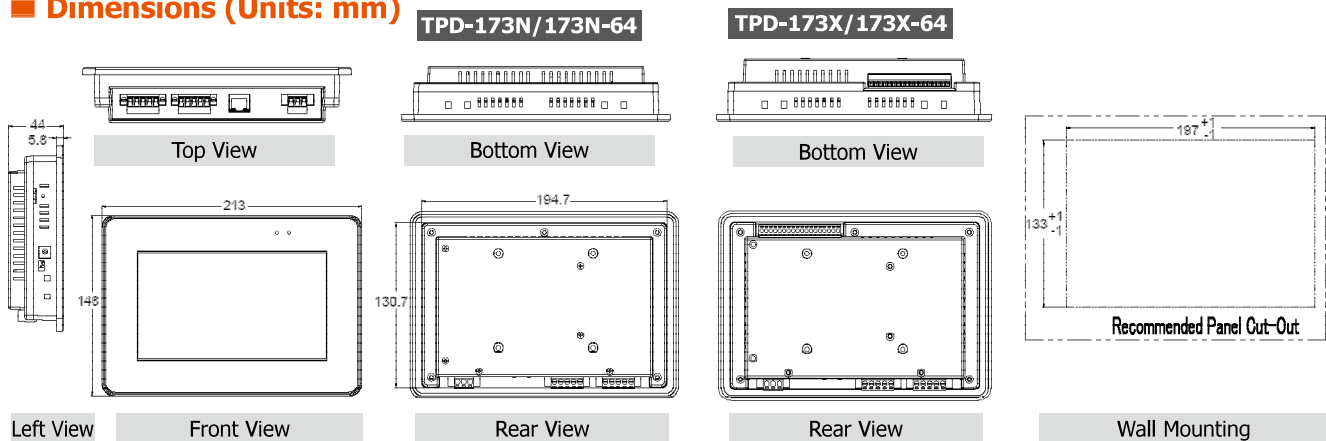

## Ordering Information

<b>VPD-173N CR</b>	7" Touch HMI Device with 2 x RS-232/RS-485, Ethernet (PoE), RTC, 16 MB Flash (RoHS)
<b>VPD-173X CR</b>	7" Touch HMI Device with 2 x RS-232/RS-485, Ethernet (PoE), RTC, 16 MB Flash, Support XV-board (RoHS)
<b>VPD-173N-64 CR</b>	7" Touch HMI Device with 2 x RS-232/RS-485, Ethernet (PoE), RTC, 64 MB Flash (RoHS)
<b>VPD-173X-64 CR</b>	7" Touch HMI Device with 2 x RS-232/RS-485, Ethernet (PoE), RTC, 64 MB Flash, Support XV-board (RoHS)

## Accessories



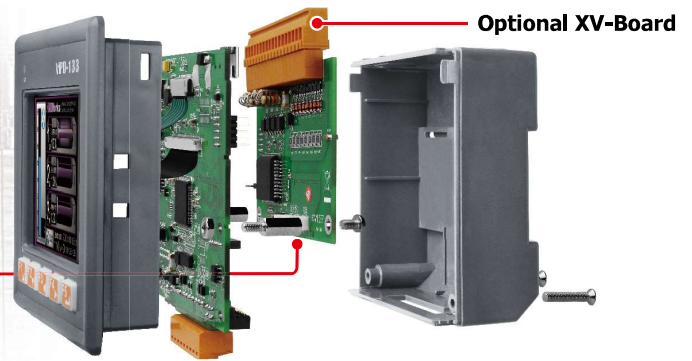

 NS-208PSE CR	Unmanaged Industrial PoE (Power over Ethernet) Ethernet Switch (RoHS)	 MDR-60-24 CR	24 VDC/2.5 A, 60 W Power Supply with DIN-Rail Mounting (RoHS)
--	---	--	---

# XV-Board Series

Making VPD series  
have its own I/O to control!



Model	DIO Board					Relay Output Board	
	XV107	XV107A	XV110	XV111	XV111A	XV116	
Image							
<b>Digital Input</b>							
Channel	8	8	16			5	
Contact	Wet	Wet	Dry+Wet			Wet	
Sink/Source (NPN/PNP)	Source	Sink	Sink/Source			Sink/Source	
Wet Contact	On Voltage Level	+3.5 Vdc ~ +50 Vdc				+3.5 Vdc ~ +50 Vdc	
	Off Voltage Level	+1 VDC Max.				+1 VDC Max.	
Dry Contact	On Voltage Level	-	Close to GND			-	
	Off Voltage Level	-	Open			-	
Counters	Channels	8	16			5	
	Max. Count	32-bit (0 ~ 4, 294, 967, 285)				32-bit (0 ~ 4, 294, 967, 285)	
	Max. Input Frequency	50 Hz				50 Hz	
	Min. Pulse Width	10 ms				10 ms	
Input Impedance	10 KΩ, 0.5 W					10 KΩ, 0.5 W	
Overvoltage Protection	70 Vdc					70 Vdc	
<b>Digital Output</b>							
Channel	8			16			
Type	Open Collector	Open Emitter		Open Collector	Open Emitter		
Sink/Source (NPN/PNP)	Sink	Source		Sink	Source		
Load Voltage	+3.5 VDC ~ 50 Vdc	+10 Vdc ~ 40 Vdc		+3.5 VDC ~ 50 Vdc	+10 VDC ~ 40 Vdc		
Max. Load Current	700 mA/channel	650 mA/channel		600 mA/channel			
Overload Protection	1.4 A			1.4 A			
<b>Relay Output</b>							
Channel					2 (channel 0, 1)	4 (channel 2~5)	
Type					Signal Relay	Power Relay	
Form A Relay	Contact Rating					2 A @ 30 VDC 0.24 A @ 220 VDC 0.25 A @ 250 VAC	6 A @ 35 VDC 6 A @ 240 VAC
	Min. Contact Load					10 mA @ 20 mV	100 mA @ ≥ 12 V
	Contact Material					Silver Nickel, Gold-covered	Silver Cadmium Alloy
	Operate Time					3 ms (typical)	5 ms (typical)
	Release Time					4 ms (typical)	1 ms (typical)
	Mechanical Endurance					10 <sup>8</sup> ops.	30 X 10 <sup>6</sup> ops.
	Electrical Endurance					2 X 10 <sup>5</sup> ops.	1 X 10 <sup>5</sup> ops.
<b>Isolation</b>							
Intra-module Isolation	3750 VDC (Field to Logic)						
<b>Power Requirements</b>							
Consumption	0.15 W	0.45 W	0.25 W	0.2 W	0.8 W	1.2 W	

Multifunction Board					
Model	XV303	XV306	XV307	XV308	XV310
Image					
<b>Analog Input</b>					
Channel		4		8	4
Sensor Type		$\pm 1\text{ V}, \pm 2.5\text{ V}, \pm 5\text{ V},$ $\pm 10\text{ V}, 0 \sim 20\text{ mA}, 4$ $\sim 20\text{ mA}, \pm 20\text{ mA}$ ( Jumper selectable )		$\pm 1\text{ V}, \pm 2.5\text{ V}, \pm 5\text{ V}, \pm 10\text{ V},$ $0 \sim 20\text{ mA}, 4 \sim 20\text{ mA}, \pm 20\text{ mA}$ ( Jumper selectable )	
Resolution	-	16-bit	-	16-bit	
Sampling Rate	Normal Mode	10 Hz		10 Hz	
	Fast Mode	200 Hz		200 Hz	
Input Impedance		20 M $\Omega$		20 M $\Omega$	
Overvoltage Protection		120 VDC		120 VDC	
<b>Analog Output</b>					
Channel	4		2		2
Range	0 V $\sim$ +5 V, $\pm 5\text{ V},$ 0 V $\sim$ +10 V, $\pm 10\text{ V},$ 0 mA $\sim$ +20 mA, +4 mA $\sim$ +20 mA (Jumper Selectable)	-	0 V $\sim$ +5 V, $\pm 5\text{ V},$ 0 V $\sim$ +10 V, $\pm 10\text{ V},$ 0 mA $\sim$ +20 mA, +4 mA $\sim$ +20 mA (Jumper Selectable)	-	0 V $\sim$ +5 V, $\pm 5\text{ V},$ 0 V $\sim$ +10 V, $\pm 10\text{ V},$ 0 mA $\sim$ +20 mA, +4 mA $\sim$ +20 mA (Jumper Selectable)
Resolution	12-bit		12-bit		12-bit
Voltage Output Capability	10 V @ 20 mA		10 V @ 20 mA		10 V @ 20 mA
Current Load Resistance	500 $\Omega$		500 $\Omega$		500 $\Omega$
<b>Universal Digital Input/Output</b>					
Channel		-		DI+DO=8 (by Wire)	-
<b>Digital Input</b>					
Channel	4	4	-	-	4
Sink/Source (NPN/PNP)	Sink/Source	Sink/Source	Source	Source	Source
Wet Contact	On Voltage Level	$+3.5 \sim +50\text{ VDC}$		+1 Vdc Max.	-
	Off Voltage Level	$+1\text{ Vdc Max.}$		+4 $\sim$ 30 VDC	-
Dry Contact	On Voltage Level	-		Close to GND	Close to GND
	Off Voltage Level	-		Open	Open
Counters	Max. Count	32-bit (0 $\sim$ 4,294,967,285)			
	Max. Input Frequency	50 Hz			
	Min. Pulse Width	10 ms			
Overload Protection	70 Vdc	70 Vdc	60 VDC	60 VDC	60 VDC
<b>Digital Output</b>					
Channel	4	4	-	-	4
Type	Power Relay (Form A)			Sink	Source
Load Voltage				3.5 $\sim$ 50 VDC	+10 $\sim$ +40 VDC
Max. Load Current				700 mA	650 mA/channel
Overload Protection				60 VDC	47 VDC
Contact Rating	6 A @ 35 VDC 6 A @ 240 VAC				
Min. Contact Load	100 mA @ $\geq 12\text{ V}$				
Operate/Release Time	5 ms (typical)/1 ms (typical)				
Mechanical/Electrical Endurance	30 x 10 <sup>6</sup> ops./1 x 10 <sup>5</sup> ops.				
<b>Isolation</b>					
Intra-module Isolation, Field to	2000 Vdc				
<b>Power Requirements</b>					
Consumption	1.6 W		0.8 W		1.6 W