



PET-7200/ET-7200 Quick Start

V1.2, March 2018

Supported Products

- ET-7200 Series
- ET-7200-UT Series
- PET-7200 Series

Technical Support

PET-7200 / ET-7200 User Manual

http://ftp.icpdas.com/pub/cd/6000cd/napdos/et7000_et7200/document/

What's in the Box?



PET-7200/ET-7200 Module



Quick Start

1 Factory Default Settings

Network Connection	Default	Authentication	Default
IP Address:	192.168.255.1	User name:	Admin
Subnet Mask:	255.255.0.0	Password:	Admin
Gateway:	192.168.0.1		

2 Connecting to Network, Computer and Power

Non-PoE

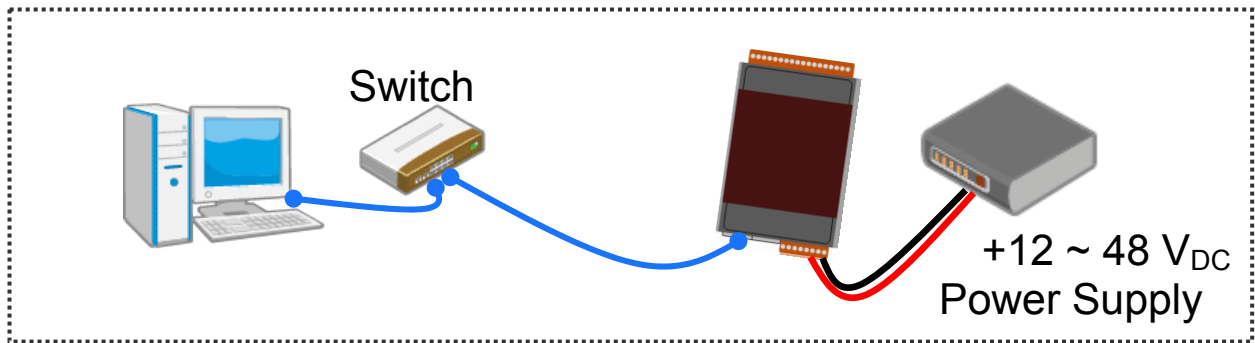

PoE

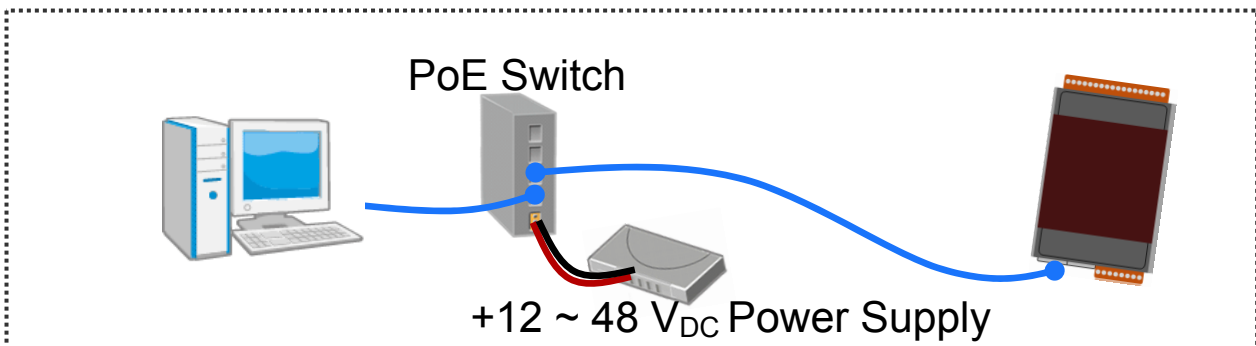

3-1 Assigning a Valid IP Address - Method 1

1) Install eSearch from

<http://ftp.icpdas.com/pub/cd/6000cd/napdos/software/esearch/>

2) Launch eSearch and click "Search Server"

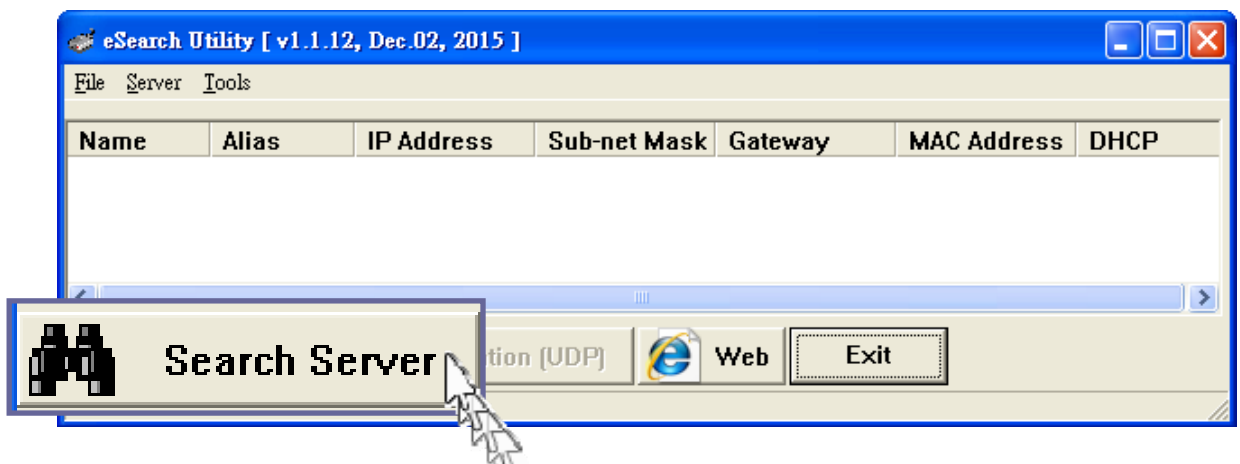

3) Double-click the name for your module on the list

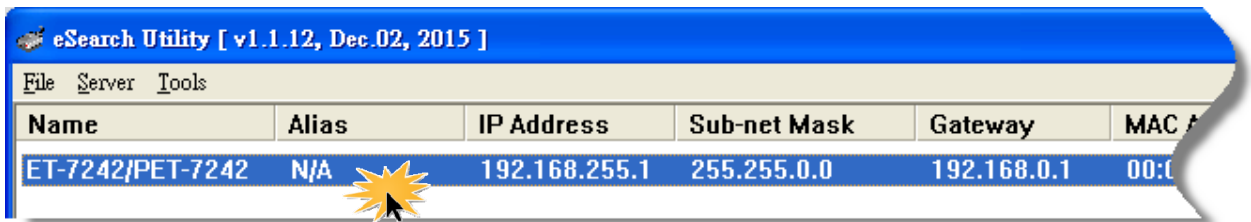

4) Enter the network configuration and click “OK”

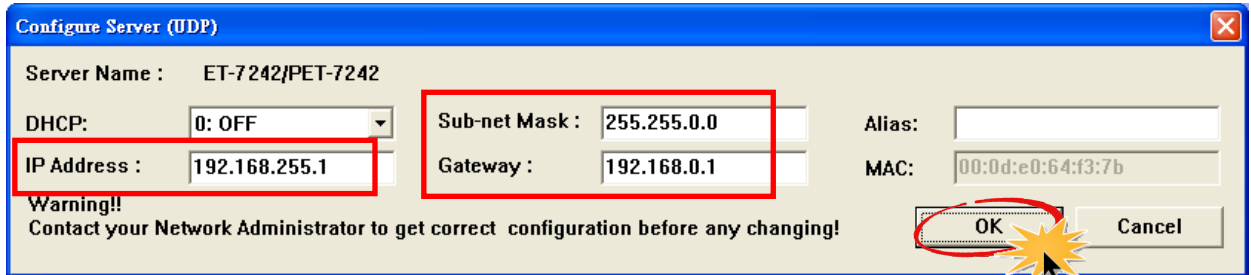

5) Repeat Step 2. to search the module again

To make sure your modifications take effect.

3-2 Assigning a Valid IP Address - Method 2

1) Set the IP configuration on your computer

The ET-7200 module comes with the default IP address of 192.168.255.1, you must chose an IP address for the computer in the range of 192.168.255.2 – 192.168.255.253 that is not in use.

2) Launch your web browser to go to the ET-7200 web interface

Enter the factory default IP address **192.168.255.1** for the ET-7200 as the URL in browser and press Enter.

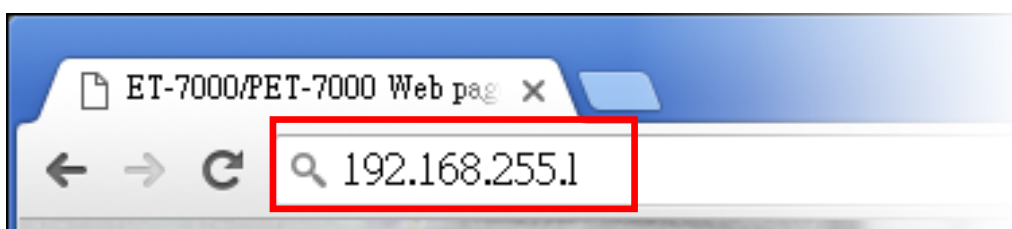

3) Fill out the User name and Password

Fill out the factory default user name and password “Admin” and then click “OK”.

4) Assign a valid IP address for your ET-7200 module

1. Click “Configuration”
2. Click “Network Settings” in the sub-menu
3. Enter a valid IP address for your ET-7200 module.
4. Click the “SUBMIT” button.

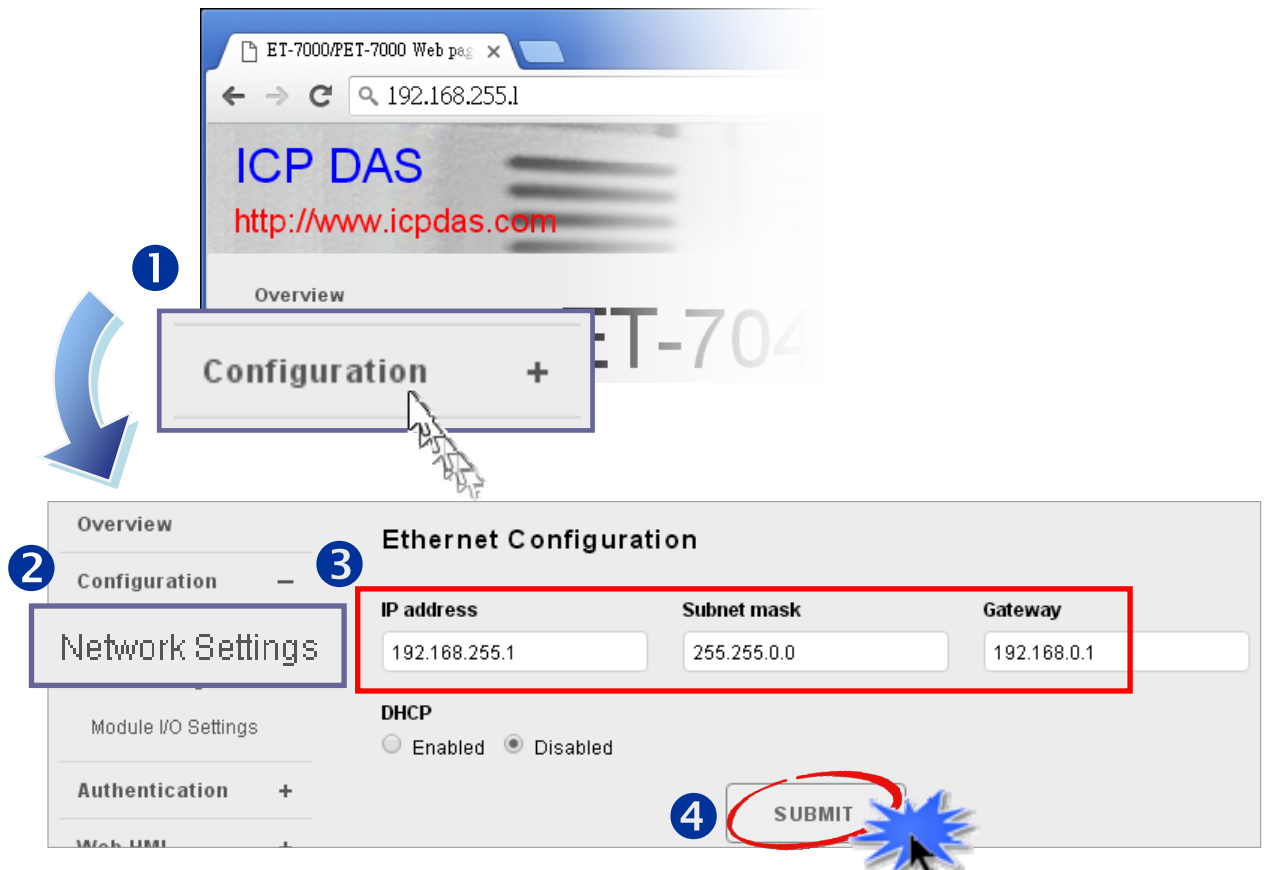

5) Restore the original IP address to your computer

4 Logging in to the ET-7200 Module

- 1) Enter the new IP for the ET-7200 as the URL in browser
- 2) Fill out the User name and Password “Admin” again
- 3) Welcome to ET-7200 web site