

DL-100TM485(P)S/

DL-100TM485(P)S-W User Manual

Warranty

All products manufactured by ICP DAS are under warranty regarding defective materials for a period of one year from the date of delivery to the original purchaser.

Warning

ICP DAS assumes no liability for any damage resulting from the use of this product. ICP DAS reserves the right to change this manual at any time without notification. The information furnished by ICP DAS is believed to be accurate and reliable. However, no responsibility is assumed by ICP DAS for its use, nor for any infringements of patents or other rights of third parties resulting from its use.

Copyright

Copyright© 2023 ICP DAS. All rights reserved.

Trademarks

Names are used for identification purposes only and may be registered trademarks of their respective companies.

Date: 2023/4/21

DL-100TM485S/DL-100TM485(P)S-W

DL-100TM485S/DL-100TM485(P)S-W

Table of Contents

DL-100TM485(P)S/ DL-100TM485(P)S-W User Manual	1
Introduction.....	4
1 Hardware Information.....	5
1.1 Specifications	5
1.2 Function Block	8
1.3 Pin Assignments	8
2 Modbus RTU Protocol	9
2.1 Modbus Mapping Table.....	10
3 Utility Software	15
3.1 Before you use the Utility Software.....	15
3.2 DL-100TM485S Utility.....	16
3.3 Configuration.....	17
4 Appendix	18
4.1 LCD Information:	18

Introduction

The DL-100TM485S series are the one-channel temperature and humidity data logger module. It contains a single built-in RS-485 communication interface and an LCD indicator to display the module ID, temperature and humidity data, and allows you define the log time interval depending on your application.

The DL-100TM485S series support the Modbus RTU protocol. Refer to Section 2 for more details.

We also provide software Utility that can be used to retrieve log data and display it in a chart on your desktop, and also allow you save the log data into an Excel format file.

1 Hardware Information

1.1 Specifications

Humidity & Temperature Sensor	
Humidity Range	0 ~ 100% RH (Relative Humidity)
Humidity Resolution	0.1% RH
Humidity Accuracy	±3.0% RH for non-P version ±1.8% RH for P version
	Max.: Refer to Figure 1
Humidity Precision	±0.1% RH
Temperature Range	-20 ~ +60°C
Temperature Resolution	0.1°C
Temperature Accuracy	±0.4°C for non-P version ±0.3°C for non-P version
	Max.: refer to Figure 2.
Temperature Precision	±0.1°C
Dew Point Range	Calculated using temperature and relative humidity
Dew Point Resolution	0.1°C
LCD Display	
LCD Duty	1/4
LCD Bias	1/3
LCD Operating Voltage	3.0 V
LCD Operating Frequency	64 Hz
Power	
Protection	Power reverse polarity protection
Required Supply Voltage	+10 ~ +30 VDC
Power Consumption	≤ 0.15 W @ 24 VDC
Mechanical	
Dimensions (W x L x H)	82 mm x 172 mm x 55 mm
Cable Length	380 mm
Waterproof Level	IP66
Installation	DIN-Rail; Wall mount
Environment	
Operating Temperature	-20 ~ +60°C
Storage Temperature	-30 ~+80°C

DL-100TM485S/DL-100TM485(P)S-W

Relative Humidity	5 ~ 95% RH, Non-condensing
Communication	
Interface	RS-485; non-isolated
Baud Rate	1200 ~ 115200 bps
Protocol	Modbus RTU

DL-100TM485S/DL-100TM485(P)S-W

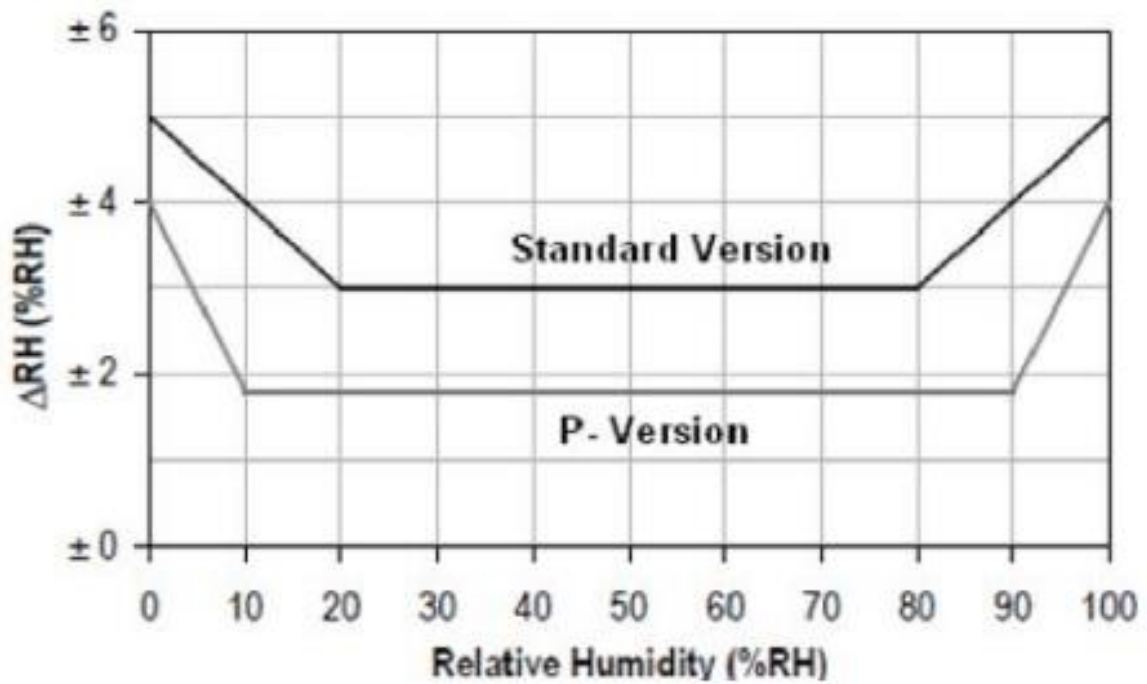

Maximum RH-tolerance at 25°C per sensor.

Figure 1

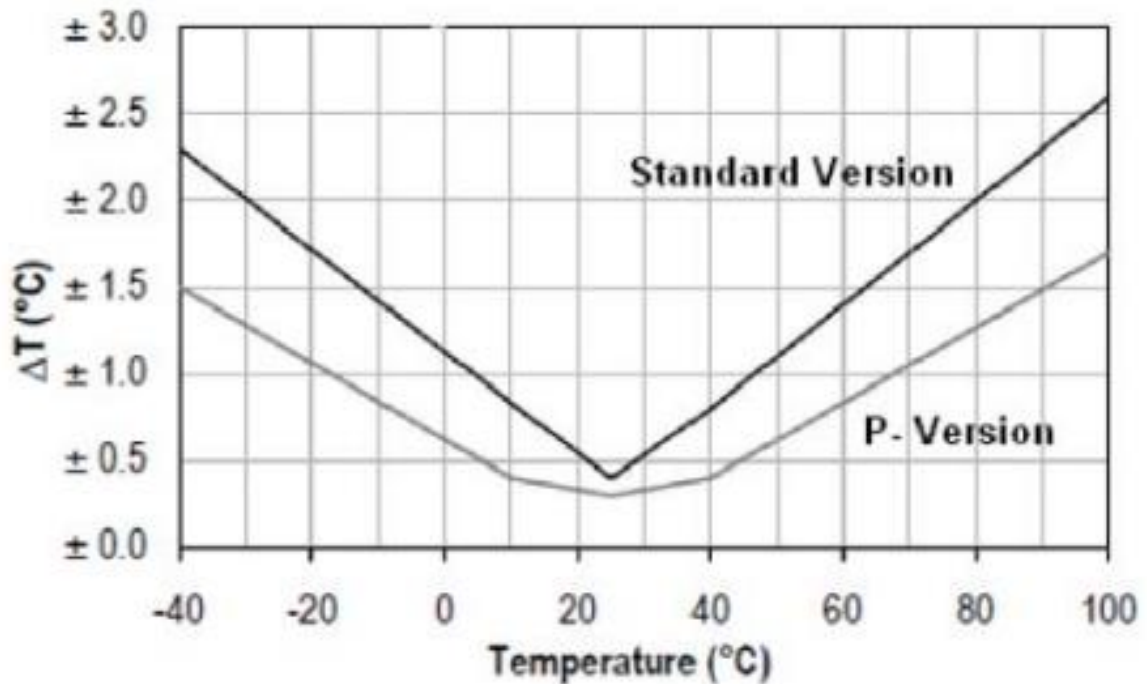

Maximum T-tolerance per sensor.

Figure 2

1.2 Function Block

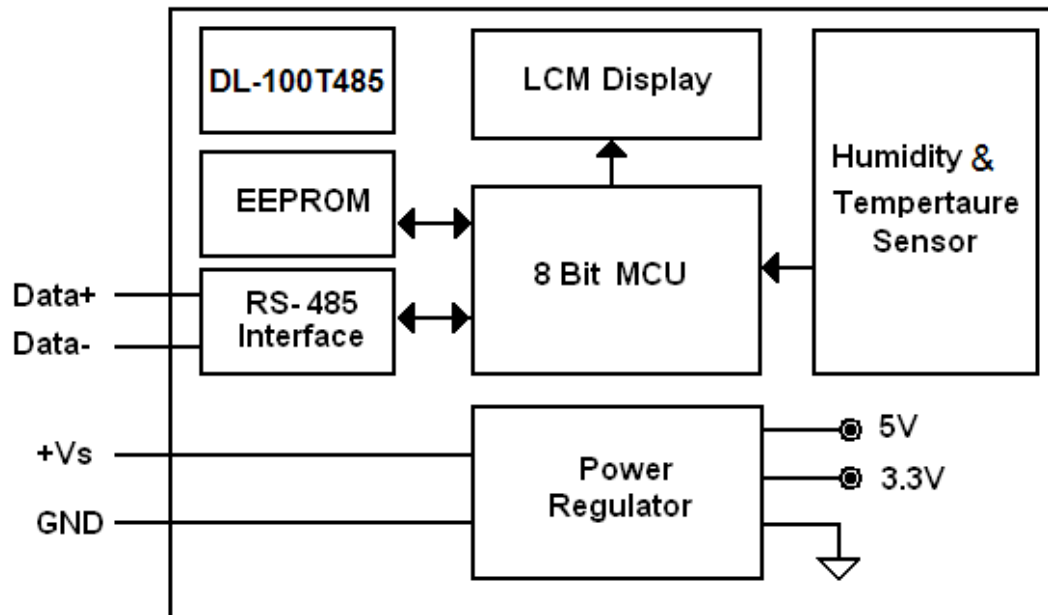

1.3 Pin Assignments

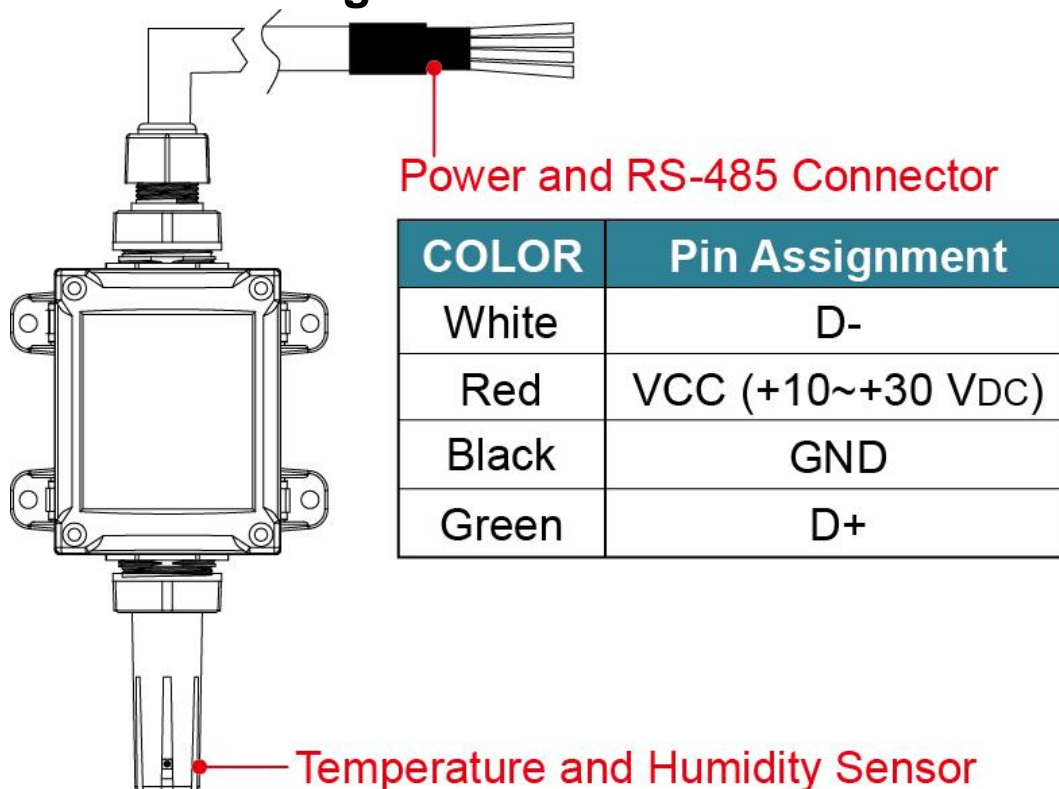

2 Modbus RTU Protocol

The Modbus protocol was originally developed for Modicon controllers by Modicon Inc. Detailed information can be found at <http://www.modicon.com/techpubs/toc7.html>. Visit <http://www.modbus.org> to find more valuable information.

The DL-100TM485S module supports the Modbus RTU protocol. The communication Baud Rate is 9600bps, and the parity, data bits and stop bits are fixed as no parity, 8 data bits and 1 stop bit. The following Modbus functions are supported.

Code	Description	Address
0x01	Read coils status	0xxxx
0x02	Read discrete inputs	1xxxx
0x03	Read multiple registers	4xxxx
0x04	Read multiple input registers	3xxxx
0x05	Write single coils	0xxxx
0x06	Write single register	4xxxx
0x0F	Write multiple coils	0xxxx
0x10	Write multiple register	4xxxx

If the function specified in the message is not supported, then the module responds as follows.

Error Response

00	Address	1 Byte	1 ~ 247
01	Function code	1 Byte	Function code + 0x80
02	Exception code	1 Byte	01

If a CRC mismatch occurs, the module will not respond.

2.1 Modbus Mapping Table

DL-100TM485S Modbus RTU Tables

Coils

Number	Address (Hex)	Function Code(s)	Access	Data Type	Name	Comments
00257	256 (0x100)	01, 02, 05, 15	R/W	Bit	Enables or disables the logging Function.	0: Disabled 1: Enabled
00258	257 (0x101)	01, 02, 05, 15	R/W	Bit	Resets the value of the log records counter to 0.	Set this bit to on to clear the log data counter value. This bit will be set to 0 when cleared successfully.
00259	258 (0x102)	01, 02, 05, 15	R/W	Bit	Set the page of the first log data which you want to read.	There are two pages of log space available in the DL-50M, and each page contains 32760 humidity and temperature data records.
10260	259 (0x103)	01, 02	R	Bit	Reset Bit.	This bit only returns a value of 1 when you read it for the first time. In all other cases, it always returns a value of 0.
10261	260 (0x104)	01, 02	R	Bit	The page number where the first log data record is stored.	0: First page 1: Second page
10262	261 (0x105)	01, 02	R	Bit	The page number where the last log data record is stored.	0: First page 1: Second page

Input Registers

Number	Address (Hex)	Function Code(s)	Access	Data Type	Name	Comments
30001	0 (0)	03, 04	R	Word	Humidity value.	The response value is the result of the original value multiplied by 100.
30002	1 (1)	03, 04	R	Word	Temperature value in degrees Celsius.	The response value is the result of the original value multiplied by 100.
30003	2 (2)	03, 04	R	Word	Temperature value in degrees Fahrenheit.	The response value is the result of the original value multiplied by 100.
*30004	3 (3)	03, 04	R	Word	Dew point temperature value in degrees Celsius.	The response value is the result of the original value multiplied by 100.
*30005	4 (4)	03, 04	R	Word	Dew point temperature value in degrees Fahrenheit.	The response value is the result of the original value multiplied by 100.
365521	65520 (FFF0)	03, 04	R	Word	Firmware version.	The response value is a hex value. The high byte denotes major version, the low byte denotes minor version.
365522	65521 (FFF1)	03, 04	R	Long HI	Module Name.	The response value is a hex value. The high byte denotes 'D', the low byte denotes 'L'.
365523	65522 (FFF2)	03, 04	R	Long LO	Module Name.	The response value is a hex value. The high byte denotes '0', the low byte denotes '50'.
365524	65523 (FFF3)	03, 04	R	Word	The number of log records.	Please refer to Table 1.

DL-100TM485S/DL-100TM485(P)S-W

Value	Time	Value	Time	Value	Time	Value	Time
0	10 seconds	3	1 minute	6	1 hour	9	6 hours
1	20 seconds	4	5 minutes	7	2 hours	0x0A	12 hours 10/22
2	30 seconds	5	10 minutes	8	6 hours	0x0B	1 day

Table 1

*Requires firmware version V2.02 or higher.

DL-100TM485S/DL-100TM485(P)S-W

Holding Registers

365525	65524 (FFF4)	03, 04 06, 16	R/W	Byte	The high byte: Module address	1~248
				Bit	The low byte: The logging mode.	0: The module will stop logging if the EEPROM memory is full. 1: The earliest stored data record will be overwritten if the EEPROM memory is full.
365526	65525 (0xFFF5)	03, 04 06, 16	R/W	Byte	The high byte: LCD display items	00~3F
					The low byte: The logging time interval.	The allowed range is from 0 to 0x0B. Refer to Table 1 for more information.
365527	65526 (0xFFF6)	03, 04 06, 16	R/W	Sign Byte	The high byte: Module baud rate	06~07 06: 9600 bps; 07:19200 bps
					The low byte: The temperature offset value.	The unit is 0.1 degrees in Celsius, the range is from -12.8°C ~ 12.7°C .
365528	65527 (0xFFF7)	03, 04 06, 16	R/W	Word	The starting address of the logging data record you want to read.	The response value will be filled with 0x7777 when this value is higher than the last address.
365529	65528 (0xFFF8)	03, 04 06, 16	R/W	Byte	The numbers of logging data records you want to read.	The response value will be filled with 0x7777 when this value is higher than the last address.
365530	65529 (0xFFF9)	03, 04 06, 16	R/W	Word	The base year and month values.	The response value is a hex value. The high byte denotes the 'year', the low byte denotes the 'month'.
365531	65530	03, 04	R/W	Word	The base day and hour values.	The response value is a hex value. The high byte

DL-100TM485S/DL-100TM485(P)S-W

	(0xFFFA)	06, 16				denotes the 'day', the low byte denotes the 'hour'.
365532	65531 (0xFFFB)	03, 04 06, 16	R/W	Word	The base minutes and seconds values.	The response value is a hex value. The high byte denotes the 'minutes', the low byte denotes the 'seconds'.
365533	65522 (0xFFFC)	03, 04 06, 16	R/W	Word	The current year and month values.	The response value is a hex value. The high byte denotes the 'current year', the low byte denotes the 'the month'.
365534	65533 (0xFFFD)	03, 04 06, 16	R/W	Word	The current day and hour values.	The response value is a hex value. The high byte denotes the 'current day', the low byte denotes the 'current hour'.
365535	65534 (0xFFFE)	03, 04 06, 16	R/W	Word	The current minute and second values.	The response value is a hex value. The high byte denotes the 'current minute', the low byte denotes the 'current second'.
*365536	65535	03, 04 06, 16	R/W	Word	The humidity offset value.	The unit is 0.01 %, the range is from -100 ~ 100%.

*Requires firmware version V2.02 or higher.

3 Utility Software





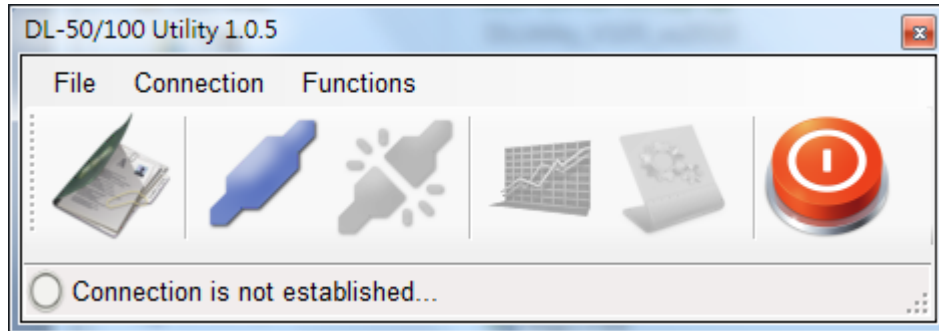

3.1 Before you use the Utility Software

1. Before you use this Utility, please make sure you have installed Microsoft .NET Framework 4. If you haven't installed .NET Framework yet, please refer to section 2 for more information, or refer to section 3 for more information about the installation of this Utility.
2. To download .NET Framework, refer:
<http://www.microsoft.com/downloads/en/details.aspx?FamilyID=9cfb2d51-5ff4-4491-b0e5-b386f32c0992&displaylang=en>
3. You also can find the Microsoft .NET Framework 4 web installer package in the following location on the enclosed CD (Napdos\Net_FrameWork\dotNetFx40_Full_setup.exe).
4. The Utility software is located in the following location on the attached CD:
Napdos\DL_100\Utility

3.2 DL-100TM485S Utility

1. After launching the Utility, the program interface will be displayed, as shown below:



- Clicking “File” or the  icon opens a previous DL-100TM485S logging data file stored on your PC.
- Clicking “Connection->Connect->RS-232/RS-485” or the  icon creates a connection from the serial port.
- Clicking “Connection->Disconnect” or the  icon disconnects the connection between the PC and the DL-100TM485S.
- Clicking * “Functions->Get Records” or the  icon retrieves the logging data which is stored in the EEPROM of the DL-100TM485S module.
- Clicking * “Functions->Configuration” or the  icon enables you to configure the DL-100TM485S module.
- Clicking “Exit” or the  icon closes the Utility software.

*This function is only valid when a connection has been successfully established between the PC and the DL-100TM485S module.

3.3 Configuration

After a connection between the PC and the DL-100TM485S has

been established, click the “” icon to configure the

DL-100TM485S. The configuration details are shown follows:

1. A new menu window would be created and the current module configurations will be displayed. After changing the values, click the “Set” button to update the configurations of the module.
2. The Log function would be disabled when you connect to the DL-100 by this Utility software, please remember to enable the log function before you terminate the Utility software.

4 Appendix

4.1 LCD Information:

- **Module Address:**

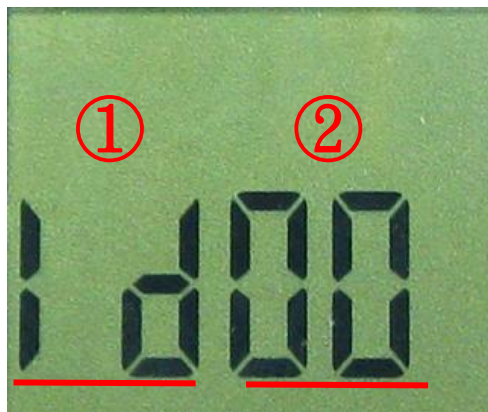

Area	LCD value	Details
①	1d	Indicates that the currently displayed information is the module address.
②	00~FF	Indicates the current module address.

● Temperature Value

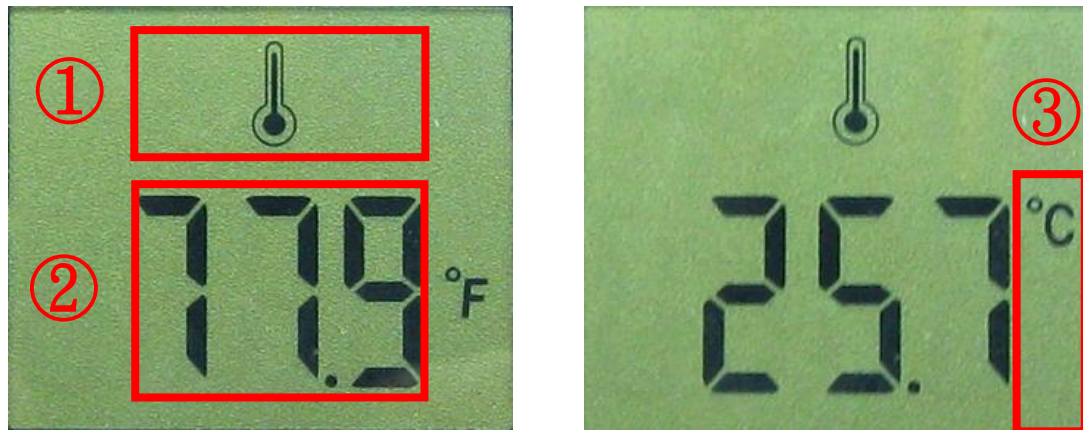

Area	LCD value	Details
①	 icon	Indicates that the currently displayed information is the temperature.
②	DDD.D~--DD.D	Indicates the current temperature value.
③	°C or °F icon	Indicates the temperature units.

● Dew Point Temperature Value

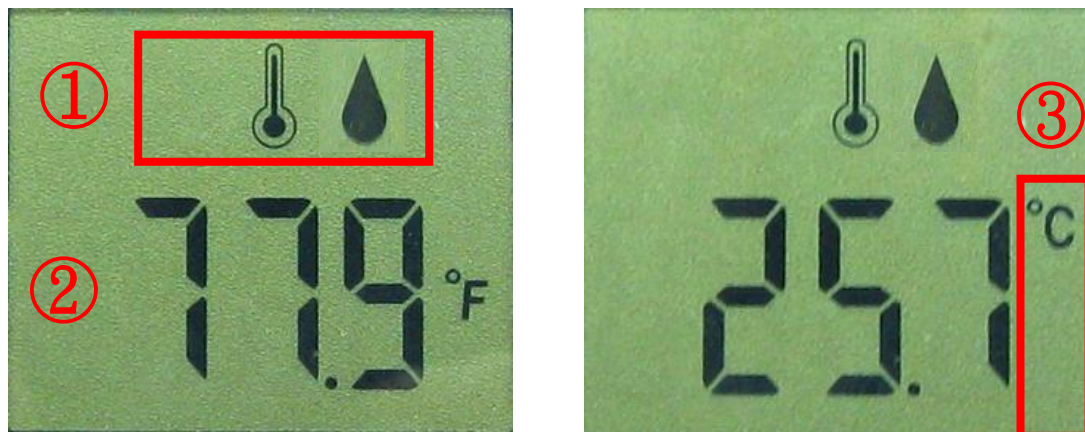

Area	LCD value	Details
①	 icon	Indicates that the currently displayed information is the dew point temperature.
②	DDD.D~--DD.D	Indicates the current temperature value.
③	°C or °F icon	Indicates the dew point temperature units.

● Humidity Value

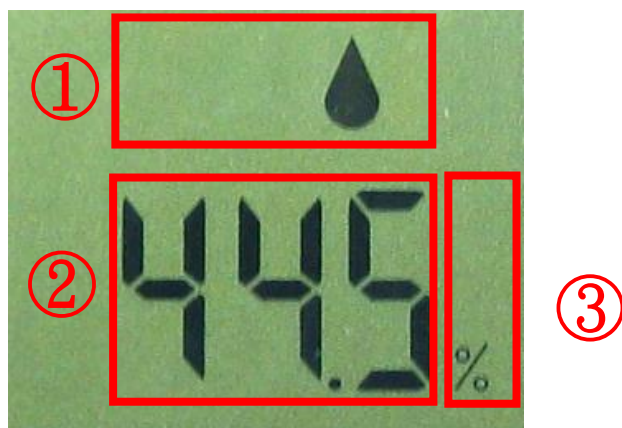

Area	LCD value	Details
①	 icon	Indicates that the currently displayed information is the humidity.
②	DD.D	Indicates the current humidity value.
③	% icon	Indicates the humidity units.

DL-100TM485S/DL-100TM485(P)S-W