



# User Manual

Version 1.0.0 Jan 2020

# GW-7828

(Modbus RTU Slave to M-Bus Master Gateway)



# Table of Contents

---

<b>1. Introduction .....</b>	<b>5</b>
1.1 Features.....	6
1.2 Specification.....	7
<b>2. Getting Started .....</b>	<b>8</b>
2.1 LED Indicator .....	9
2.2 Rotary Switch.....	10
2.3 DIP Switch .....	11
<b>3. Configuration and Communicate test .....</b>	<b>12</b>
3.1 Connect.....	13
3.2 Baud Rate and Data Format Settings .....	14
3.3 M-Bus Meter Settings .....	15
3.3.1 Import .....	16
3.3.2 Export.....	18
3.3.3 Add.....	19
3.3.4 Save .....	21
3.3.5 Delete .....	23
3.3.6 Delete All .....	25
3.4 M-Bus Meter Communicate Test.....	26
<b>4. Meter Configuration Label Description .....</b>	<b>27</b>
4.1 Serial.....	28
4.2 Protocol.....	29
4.3 Address.....	30
4.4 Medium .....	31
4.5 Value .....	32
4.6 Unit .....	33
4.7 Cycle .....	34
4.8 Description .....	35
4.9 Register.....	36

<b>Appendix A. Firmware Update .....</b>	<b>37</b>
<b>Appendix B. Revision History.....</b>	<b>38</b>

# Important Information

## Warranty

---

All products manufactured by ICP DAS are under warranty regarding defective materials for a period of one year, beginning from the date of delivery to the original purchaser.

## Warning

---

ICP DAS assumes no liability for any damage resulting from the use of this product. ICP DAS reserves the right to change this manual at any time without notice. The information furnished by ICP DAS is believed to be accurate and reliable. However, no responsibility is assumed by ICP DAS for its use, not for any infringements of patents or other rights of third parties resulting from its use.

## Copyright

---

Copyright © 2020 by ICP DAS Co., Ltd. All rights are reserved.

## Trademark

---

Names are used for identification purpose only and may be registered trademarks of their respective companies.

## Contact us

---

If you encounter any problems while operating this device, feel free to contact us via mail at: [service@icpdas.com](mailto:service@icpdas.com) . We will reply as soon as possible.

# 1. Introduction

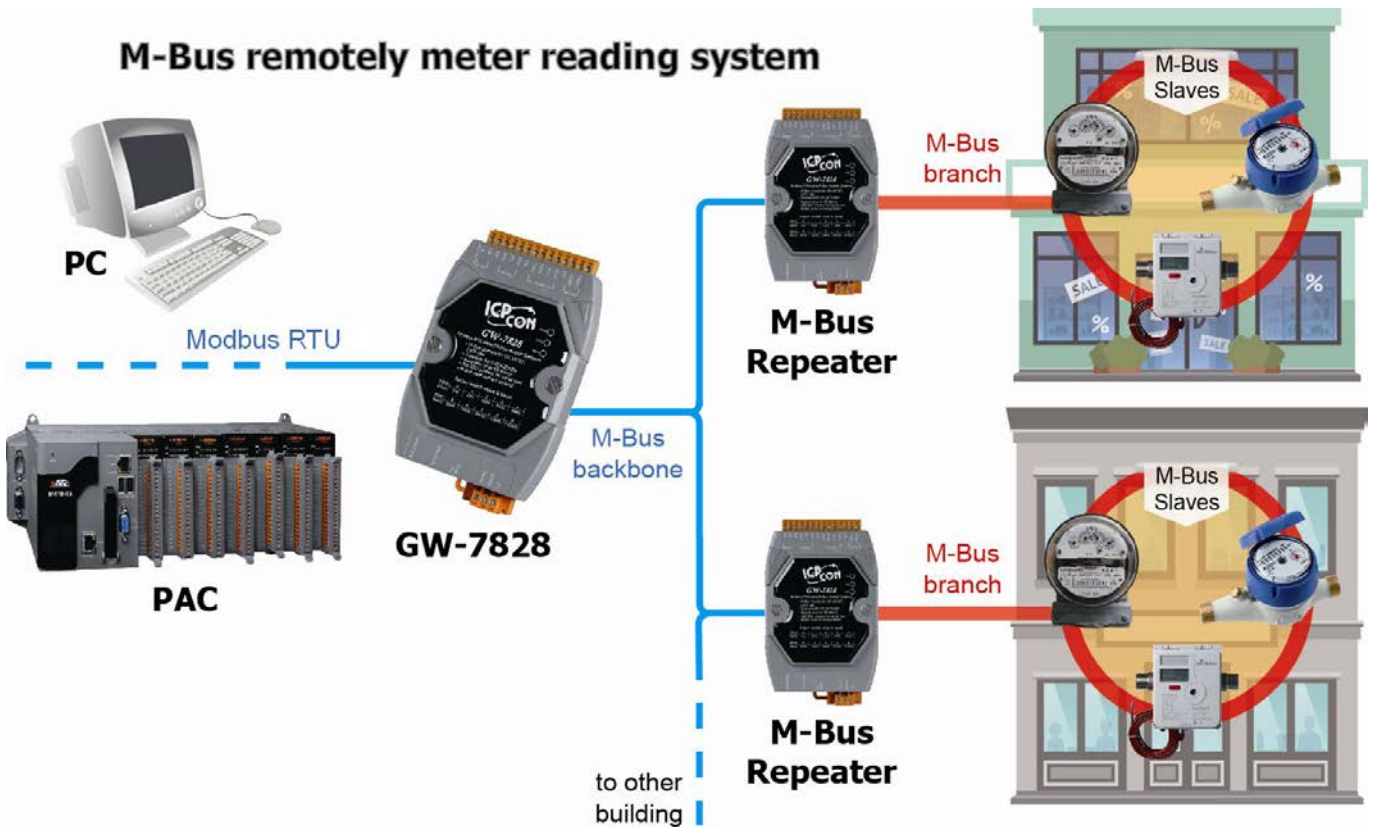

The M-Bus ("Meter-Bus") is a standard for remote reading of meters. It is usable for most types of consumption meters as well as for various sensors and actuators. The GW-7828 is specially designed for M-Bus slave device. It offers Modbus RTU communication by three kinds of interface, RS-232, RS-422 and RS-485. On hardware the GW-7828 has two rotary switches for serial port and M-Bus port baud rate. GW-7828 supports Modbus RTU function code 0x03 and 0x04 to read data of M-Bus meters. Through this design, it is easy to communicate with any standard M-Bus slave.

## 1.1 Features

- Supports M-Bus standard: EN-13757, CJ/T -188
- Supports Modbus RTU function code 0x03 and 0x04 to read Meter data
- Baud rate: Adjustable by rotary switch serial port from 300 to 115200 bps, and M-Bus from 300 to 2400 bps. Two baud rates are set individually.
- Default serial port data format: Data bit 8, Parity None, Stop bit 1
- Default M-Bus port data format: Data bit 8, Parity Even, Stop bit 1
- Supports up to 100 M-Bus slaves
- M-Bus over current protection
- Short-circuit protection on the M-Bus
- Update firmware from serial port
- Provides PWR, MTX and MRX 3 LED indicators
- Watchdog inside

## 1.2 Specification

Module	GW-7828
<b>M-Bus Interface</b>	
Channel	1
Baud Rate (bps)	300 bps ~ 2400 bps
Data bit	5, 6, 7, 8
Stop bit	1, 2
Parity	None, Even, Odd, Space, Mark
Isolation	3750 Vrms for photo-couple
ESD Protection	Contact ±4 kv class B
Current Protection	short-circuit protection
<b>UART Interface</b>	
Channel	1 RS-232 / RS-422 / RS-485 (can't be used simultaneously)
Baud Rate (bps)	300 bps ~ 115200 bps
Data bit	5, 6, 7, 8
Stop bit	1, 2
Parity	None, Even, Odd, Space, Mark
ESD Protection	Contact ±4 kv class B
<b>Power</b>	
Power Supply	Unregulated +10 ~ +30 V <sub>DC</sub>
Protection	Power reverse polarity protection, Over-voltage brown-out protection
Power Consumption	1.8 W @ 24 VDC (with 1 slave device) 11.8 W @ 24 VDC (with 100 slave devices)
<b>Mechanical</b>	
Installation	DIN-Rail
Dimension (W x L x H)	72mm x 122mm x 33mm
<b>Environment</b>	
Operating Temperature	-25 to +60°C
Storage Temperature	-40 to +80°C
Relative Humidity	10 to 90% RH, Non-condensing



## 2. Getting Started

### ■ Appearance and pin assignments

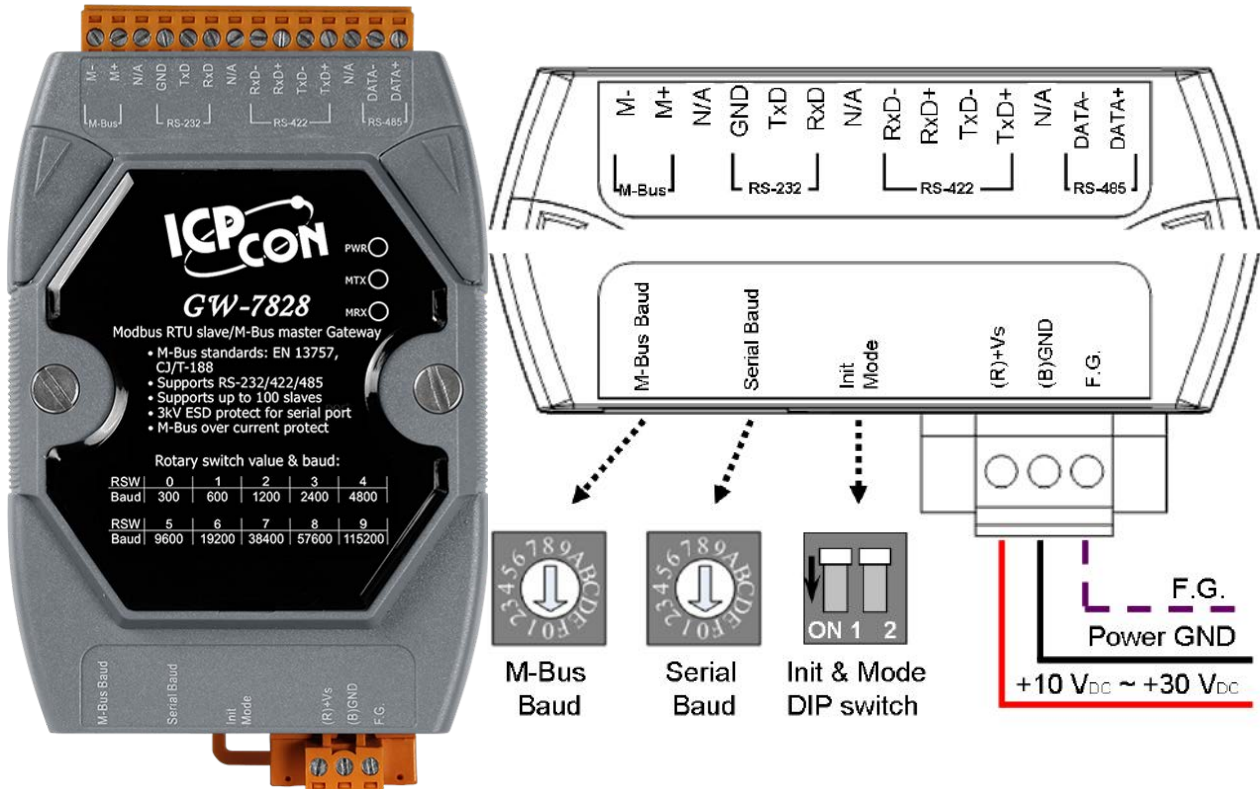



## 2.1 LED Indicator

The GW-7828 module provides three LED indicators, including indicators for power status and module status. The Following is an overview of the purpose and function of each LED indicator together with a description.

LED Name	LED Status	LED Description
<b>Power (Yellow)</b>	ON	The power of the module is ON
<b>Power (Yellow)</b>	Flashing	M-Bus overload (short or too much M-Bus slaves) Need reboot to recover the status.
<b>MTX (Green)</b>	Flashing	M-Bus communication normal Tx
<b>MRX (Green)</b>	Flashing	M-Bus communication normal Rx

\*

## 2.2 Rotary Switch

The GW-7828 module provides two rotary switches that are used to change UART Baud Rate and M-Bus Baud Rate. The following is an overview of the purpose and function of each rotary switch position together with a description.

	Switch	Baud rate (bps)	Format
	0	300	M-Bus Port:8,e,1 Serial Port:8,n,1
	1	600	
	2	1200	
	3	2400	
	4	4800	
	5	9600	
	6	19200	
	7	38400	
	8	57600	
	9	115200	
	A~F	User defined	User defined

Note: M-Bus only supports baud rate from 300 to 2400 bps.

## 2.3 DIP Switch

The DIP switch is used to update firmware and configure M-Bus Meter setting. The functions of each mode will be explained in detail in later chapters. After changing the configuration of the DIP switch, the GW-7828 needs to reboot to enable the new setting.

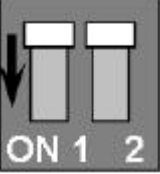
	Init Pin	Mode Pin	Description
	OFF	OFF	Operation Mode
	OFF	ON	Configure Mode
	ON	OFF	Firmware Update Mode
	ON	ON	Reserved

### 3. Configuration and Communicate test

The configuration for the module parameters or communication setting on the GW-7828 module can be performed via M-Bus utility. The M-Bus utility can be downloaded from the following website:

[http://ftp.icpdas.com.tw/pub/cd/fieldbus\\_cd/mbus/gateway/gw-7828/software/](http://ftp.icpdas.com.tw/pub/cd/fieldbus_cd/mbus/gateway/gw-7828/software/)

The figure below is an illustration of module wiring. Connect the PC COM port to the RS-232 port and connect M-Bus meter to M-Bus port of the GW-7828. Set the DIP switch to the configuration mode and then power it on.

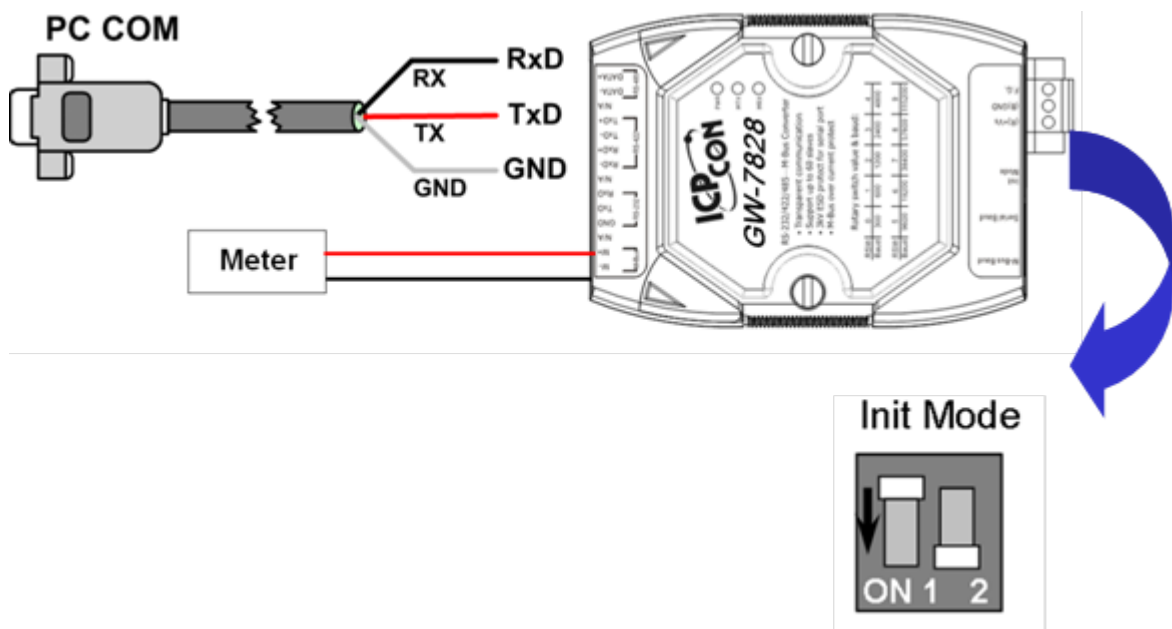

## 3.1 Connect

Execute the M-Bus utility. There will be a connection diagram as first.

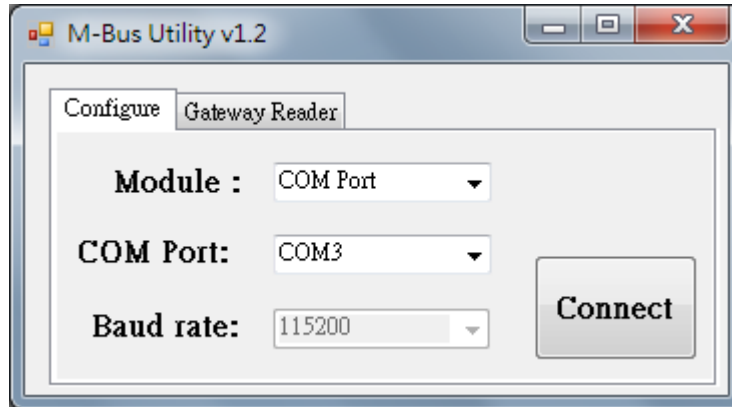

Click "Configure" tab page, choose the corresponding COM port in PC then click "Connect" button to connect with module. Please be noted that the UART baud rate of GW-7828 will be 115200bps when it is in configuration Mode.

## 3.2 Baud Rate and Data Format Settings

The first page of the utility lists baud rate and data format configuration of the serial port and the M-Bus port and it also shows the Modbus RTU node ID of the GW-7828. User could add a new baud rate and data format setting as need in this page.

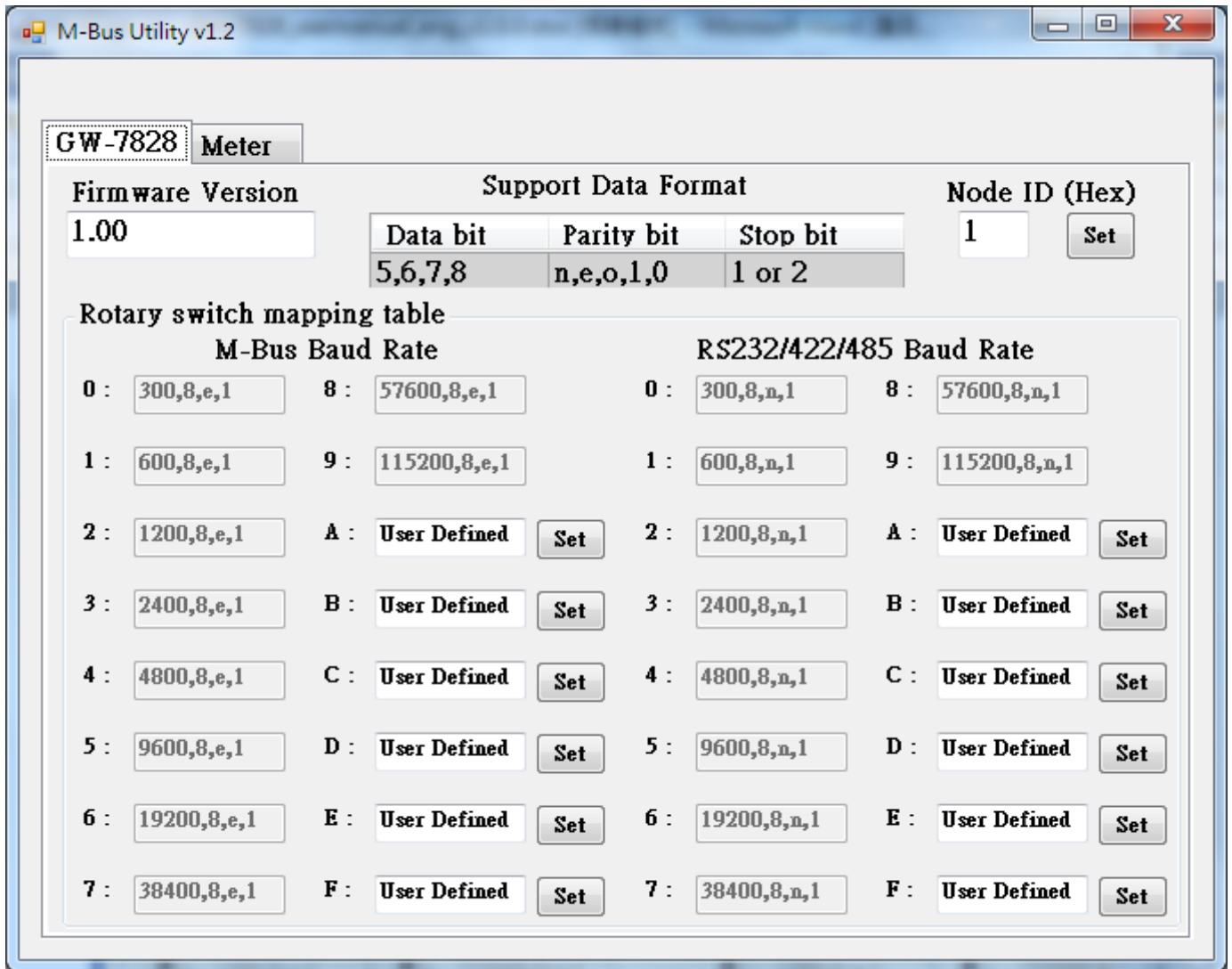

Note: The GW-7828 only supports 300 bps ~ 2400 bps baud rate currently.

### 3.3 M-Bus Meter Settings

In the “Meter” page of the utility, user could configure the M-Bus communication setting by using “Import” or “Add” functions. The usages of these functions are listed as following sections.

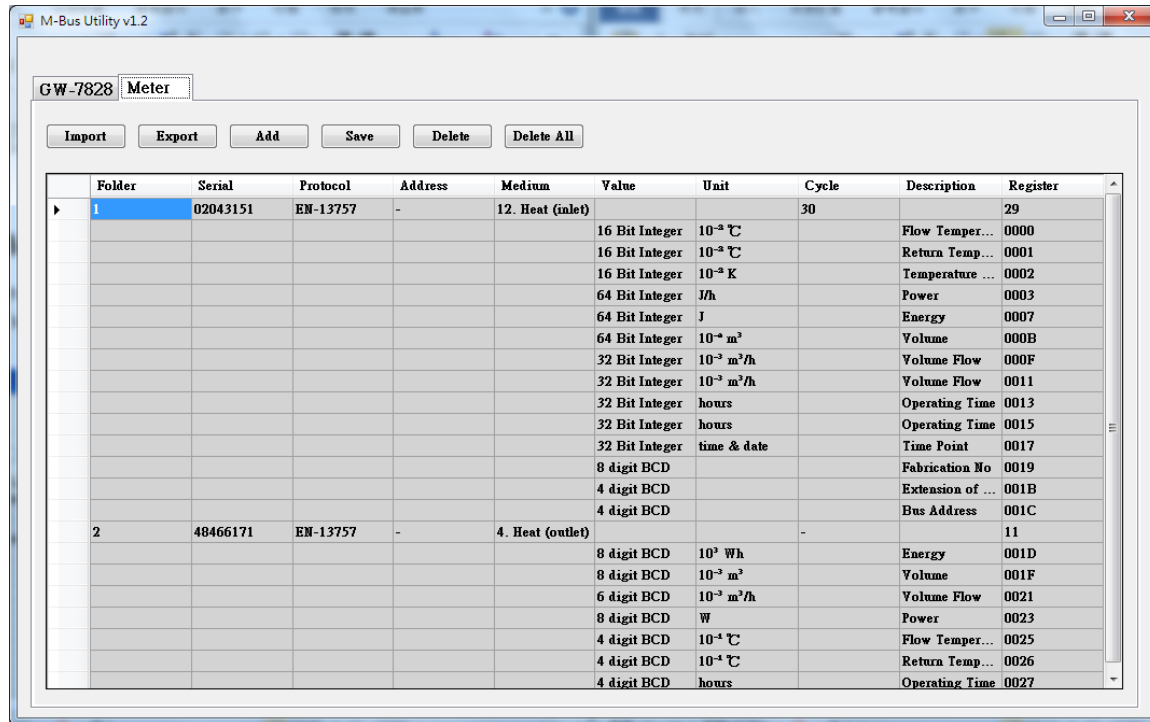



### 3.3.1 Import

There are two ways to add M-Bus Meter setting into GW-7828. One is using “Import” to import an existed configuration file and save to GW-7828. The configure steps are as following:

Step1: Press “Import” button.

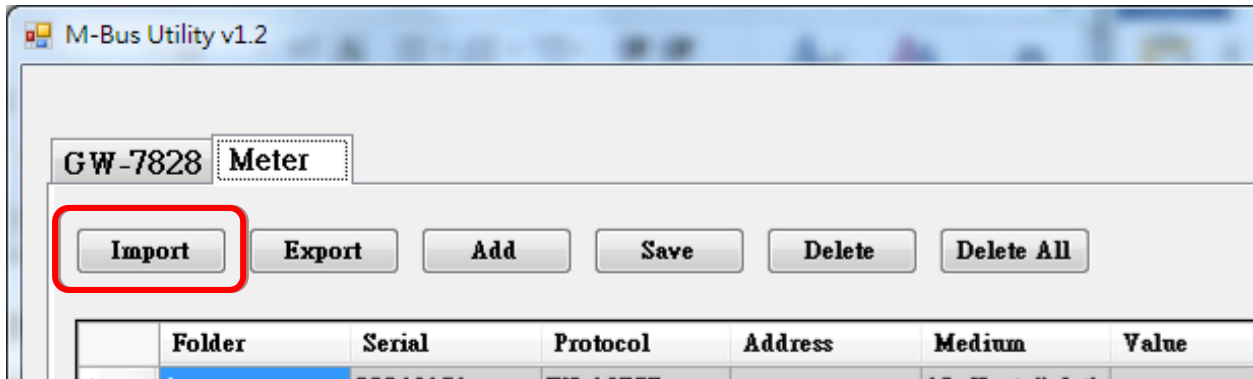

Step2: Open an existed configuration file of XML format.

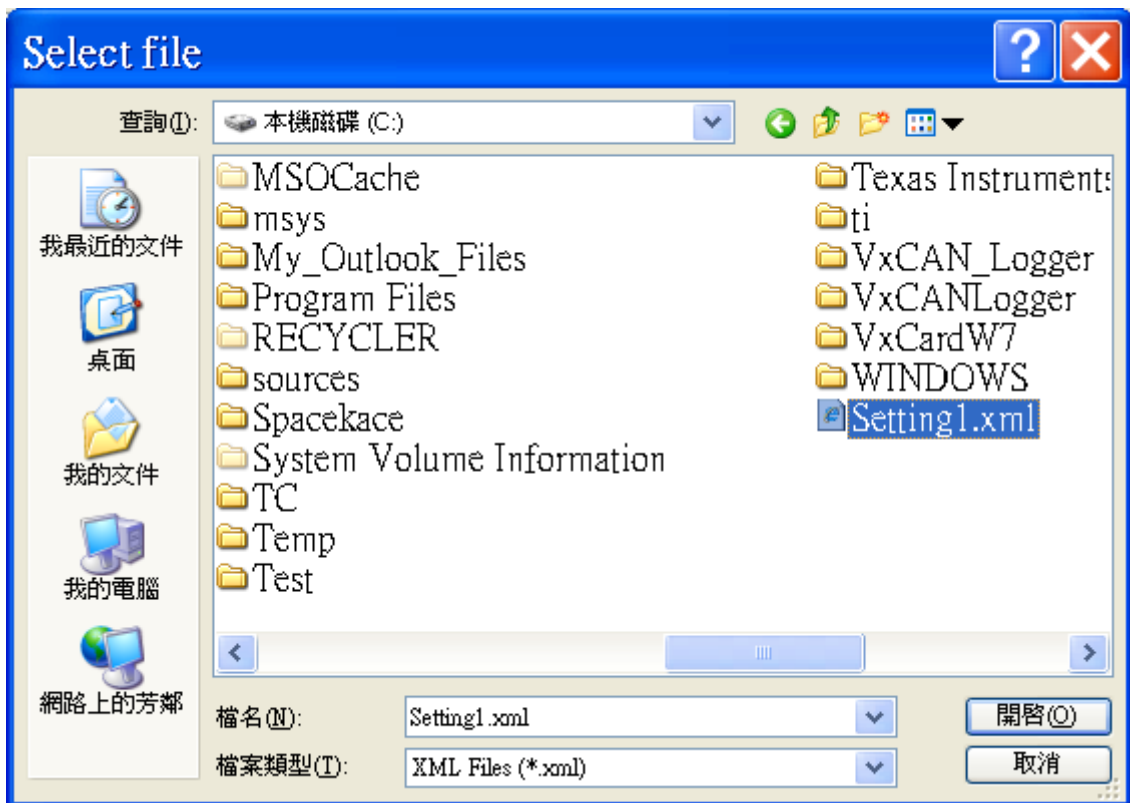

Step3: The configuration will be loaded into the utility as following:

M-Bus Utility v1.2

GW-7828 Meter

Import Export Add Save Delete Delete All

Folder	Serial	Protocol	Address	Medium	Value	Unit	Cycle	Description	Register
1	02043151	EN-13757	-	12. Heat (inlet)			30		
					16 Bit Integer	10 <sup>-2</sup> °C		Flow Temper...	0000
					16 Bit Integer	10 <sup>-2</sup> °C		Return Temp...	0001
					16 Bit Integer	10 <sup>-2</sup> K		Temperature ...	0002
					64 Bit Integer	J/h		Power	0003
					64 Bit Integer	J		Energy	0007
					64 Bit Integer	10 <sup>-4</sup> m <sup>3</sup>		Volume	000B
					32 Bit Integer	10 <sup>-3</sup> m <sup>3</sup> /h		Volume Flow	000F
					32 Bit Integer	10 <sup>-3</sup> m <sup>3</sup> /h		Volume Flow	0011
					32 Bit Integer	hours		Operating Time	0013
					32 Bit Integer	hours		Operating Time	0015
					32 Bit Integer	time & date		Time Point	0017
					8 digit BCD			Fabrication No	0019
					4 digit BCD			Extension of ...	001B
					4 digit BCD			Bus Address	001C
2	48466171	EN-13757	-	4. Heat (outlet)			-		
					8 digit BCD	10 <sup>2</sup> Wh		Energy	001D
					8 digit BCD	10 <sup>-3</sup> m <sup>3</sup>		Volume	001F
					6 digit BCD	10 <sup>-3</sup> m <sup>3</sup> /h		Volume Flow	0021
					8 digit BCD	W		Power	0023
					4 digit BCD	10 <sup>-1</sup> °C		Flow Temper...	0025
					4 digit BCD	10 <sup>-1</sup> °C		Return Temp...	0026
					4 digit BCD	hours		Operating Time	0027

**Step4:** Press "Save" button and confirm to save configuration.

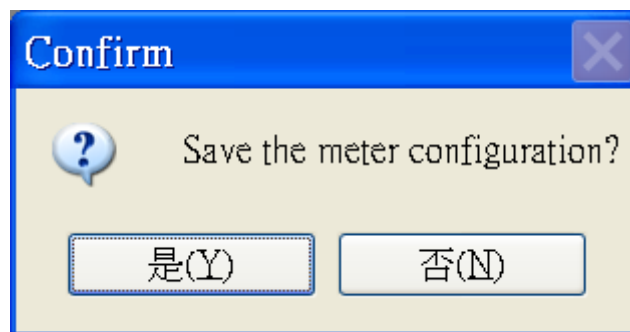

**Step5:** After saving success diagram showed, set the DIP switch to operation mode and reboot the module.



### 3.3.2 Export

User could export the existed module configuration to a XML file by the “Export” function.

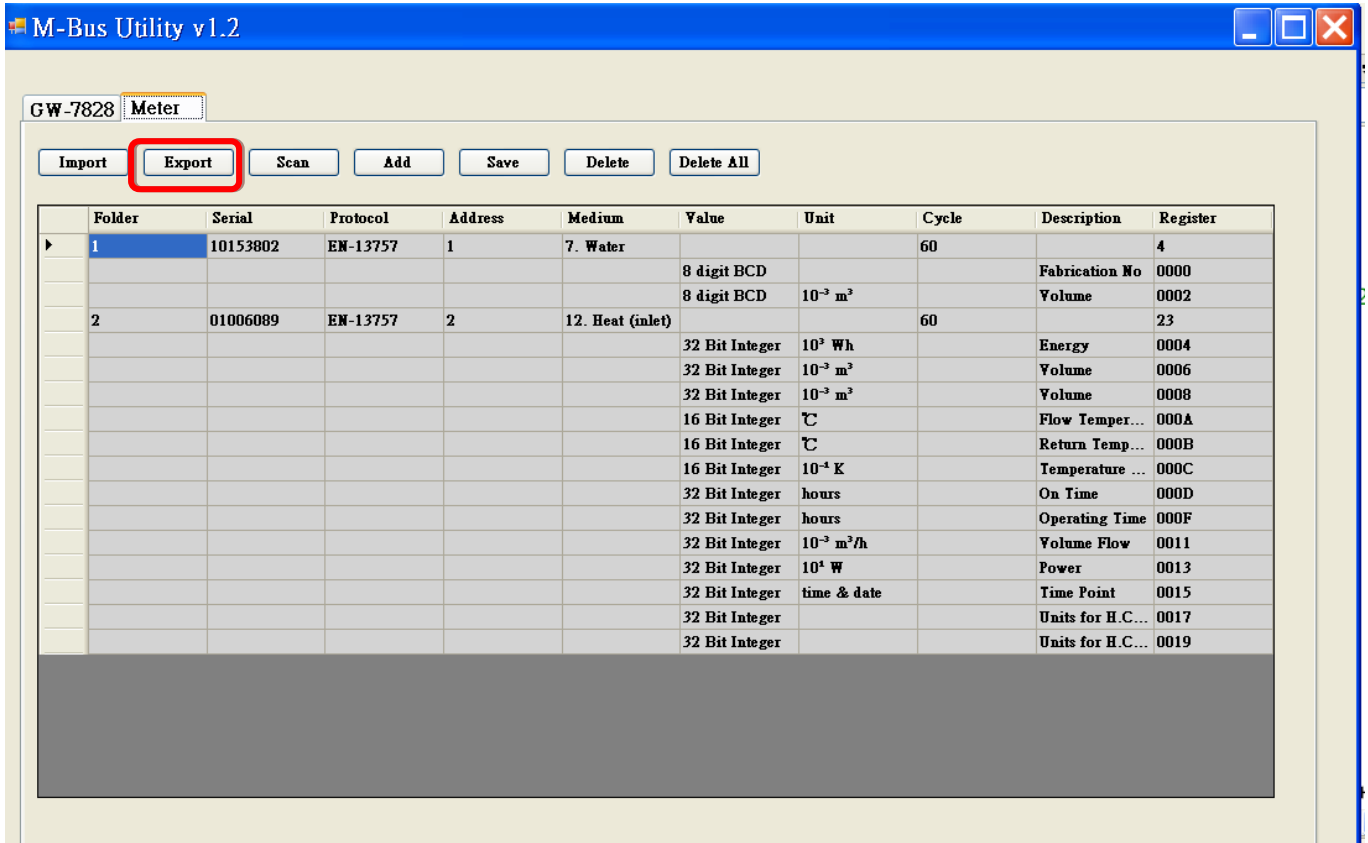

Step1: Press “Export” button. Then select path and input file name to export the configuration.

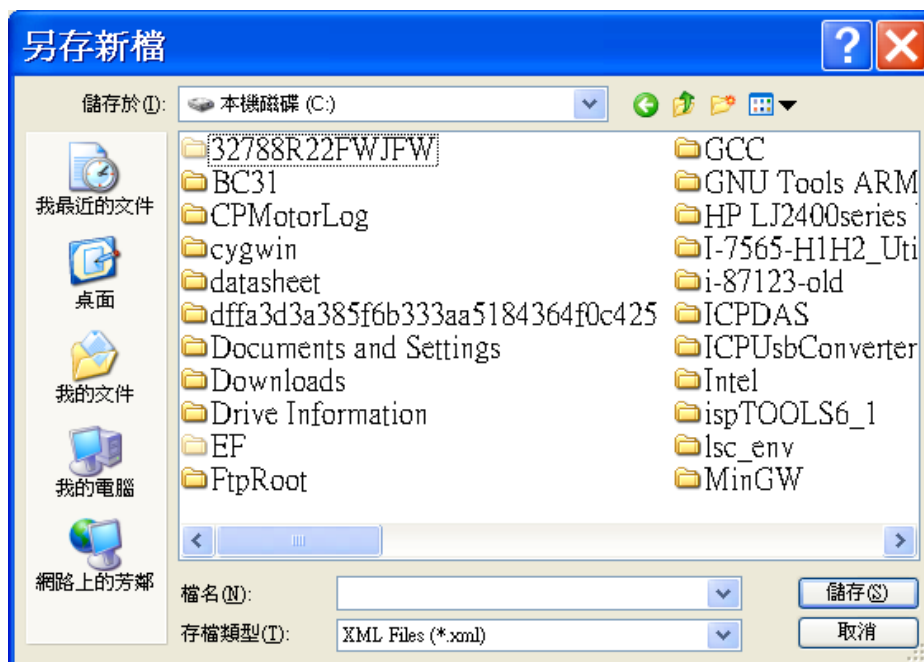

### 3.3.3 Add

The second way to add meter configuration to GW-7828 is using “Add” function. The “Add” function can add meter of EN-13757 protocol or CJ/T-188 protocol into GW-7828. Refer below operation example for detail setting step.

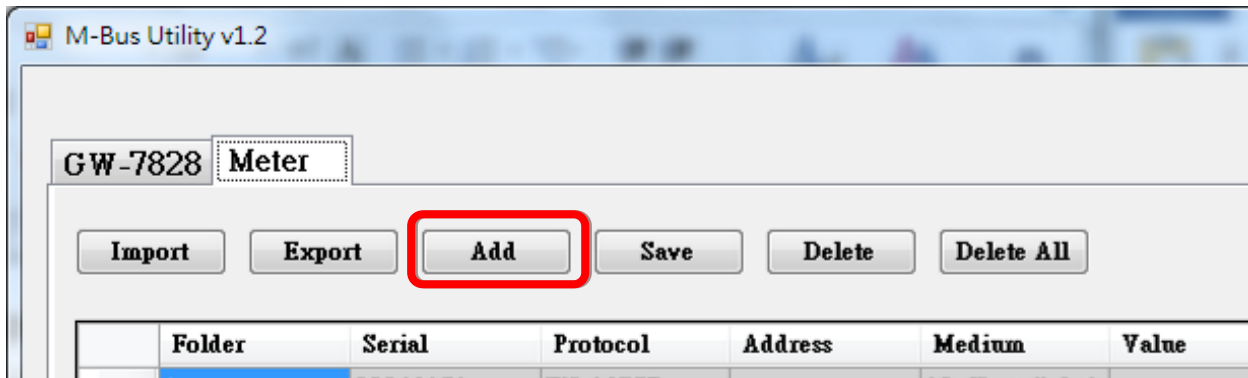

**Step1:** Press “Add” button and select the protocol of the meter. There are two protocols, EN-13757 and CJ/T188 for select. Input the meter serial number and M-Bus network polling cycle time. Then press “OK” to connect to the meter.

Note: The meter serial number of EN-13757 is 8 numbers, and the serial number of CJ/T188 is 14 numbers.

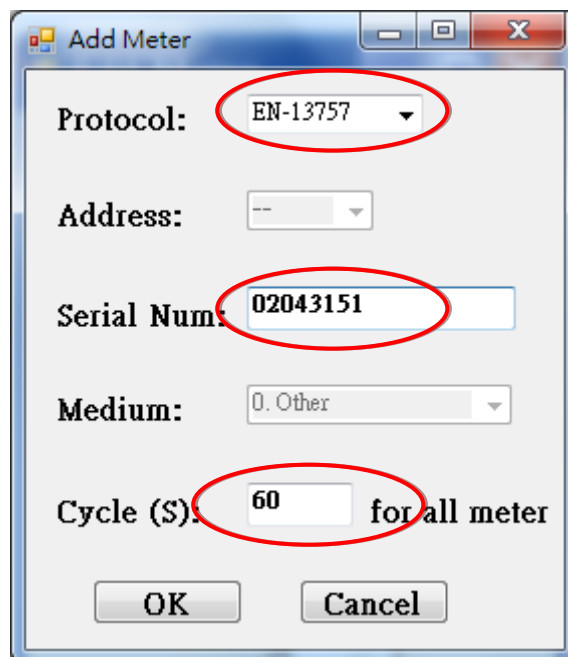

**Step2:** The meter information shows as below.

Folder	Serial	Protocol	Address	Medium	Value	Unit	Cycle	Description	Register
1	02043151	EM-13757	-	12. Heat (inlet)			30		29
					16 Bit Integer	10 <sup>-2</sup> °C		Flow Temper...	0000
					16 Bit Integer	10 <sup>-2</sup> °C		Return Temp...	0001
					16 Bit Integer	10 <sup>-2</sup> K		Temperature ...	0002
					64 Bit Integer	J/h		Power	0003
					64 Bit Integer	J		Energy	0007
					64 Bit Integer	10 <sup>-4</sup> m <sup>3</sup>		Volume	000B
					32 Bit Integer	10 <sup>-3</sup> m <sup>3</sup> /h		Volume Flow	000F
					32 Bit Integer	10 <sup>-3</sup> m <sup>3</sup> /h		Volume Flow	0011
					32 Bit Integer	hours		Operating Time	0013
					32 Bit Integer	hours		Operating Time	0015
					32 Bit Integer	time & date		Time Point	0017
					8 digit BCD			Fabrication No	0019
					4 digit BCD			Extension of ...	001B
2	48466171	EM-13757	-	4. Heat (outlet)			-		11
					4 digit BCD			Bus Address	001C
					8 digit BCD	10 <sup>3</sup> Wh		Energy	001D
					8 digit BCD	10 <sup>-3</sup> m <sup>3</sup>		Volume	001F
					6 digit BCD	10 <sup>-3</sup> m <sup>3</sup> /h		Volume Flow	0021
					8 digit BCD	W		Power	0023
					4 digit BCD	10 <sup>-4</sup> °C		Flow Temper...	0025
					4 digit BCD	10 <sup>-4</sup> °C		Return Temp...	0026
4 digit BCD	hours		Operating Time	0027					

**Step3:** After add all meters on the utility list, press “Save” to save these parameters to the GW-7828.

### 3.3.4 Save

After adding meters setting or importing configuration, use “Save” function to save configuration into the GW-7828.

Step1: Press “Save” button.

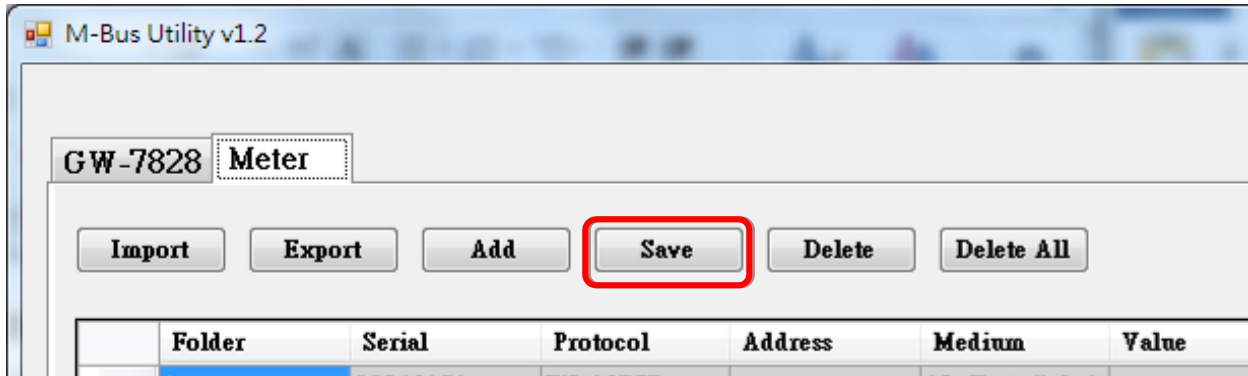

Step2: Confirm to save the configuration.

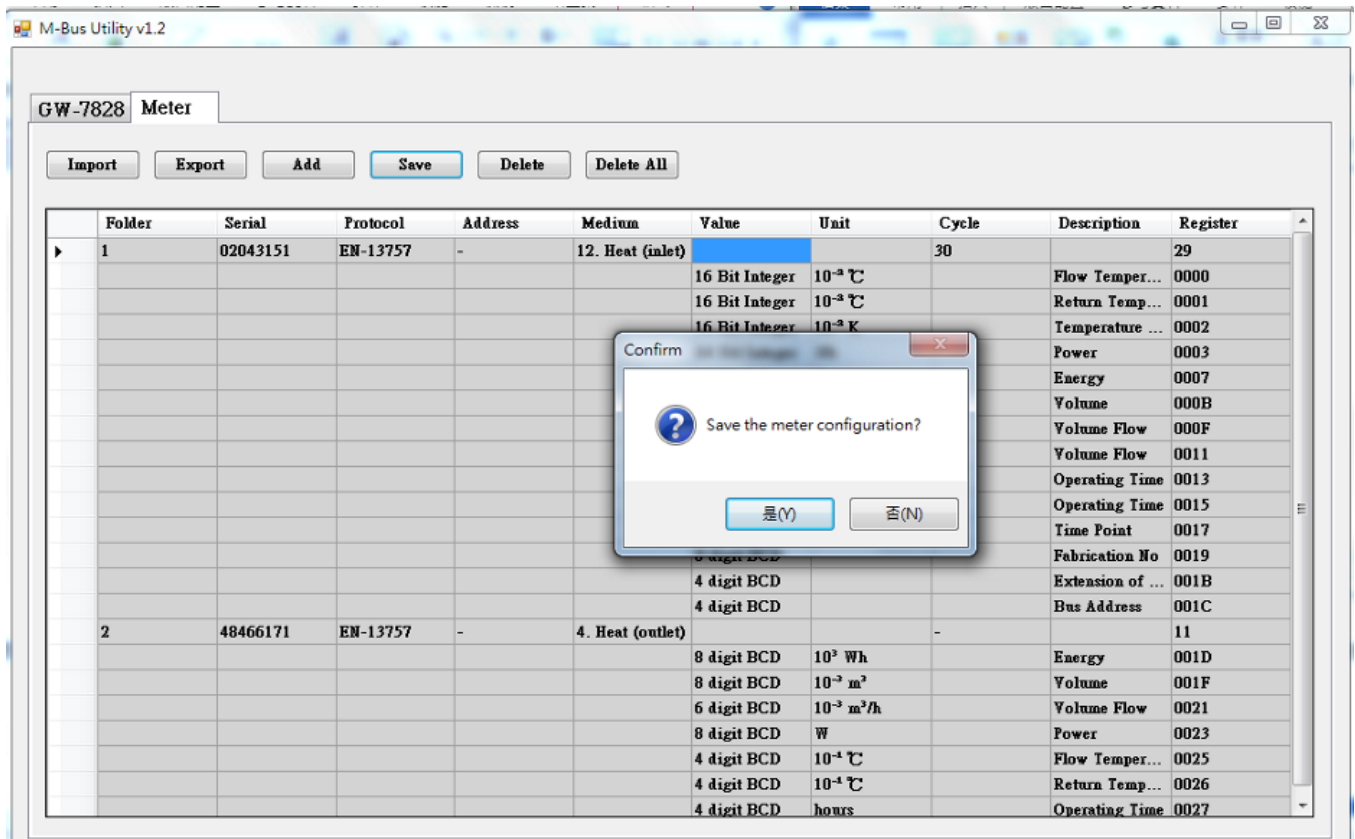

Step3: After saving success diagram showed, set the DIP switch to operation mode and reboot the module.

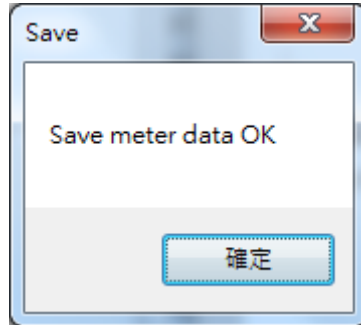



### 3.3.5 Delete

The “Delete” function will delete one meter setting each time. Take the following setting as an example.

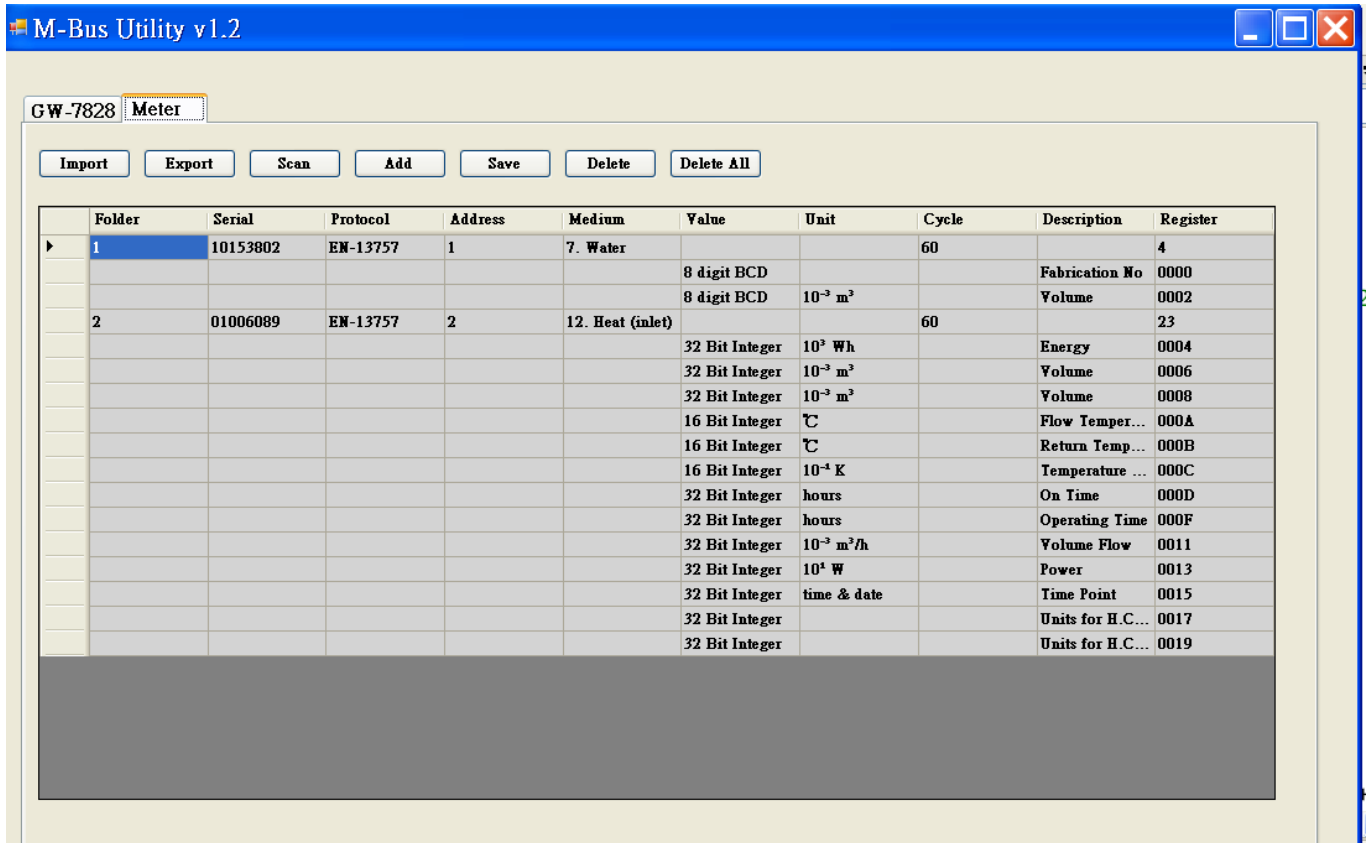

Step1: Press “Delete” button.

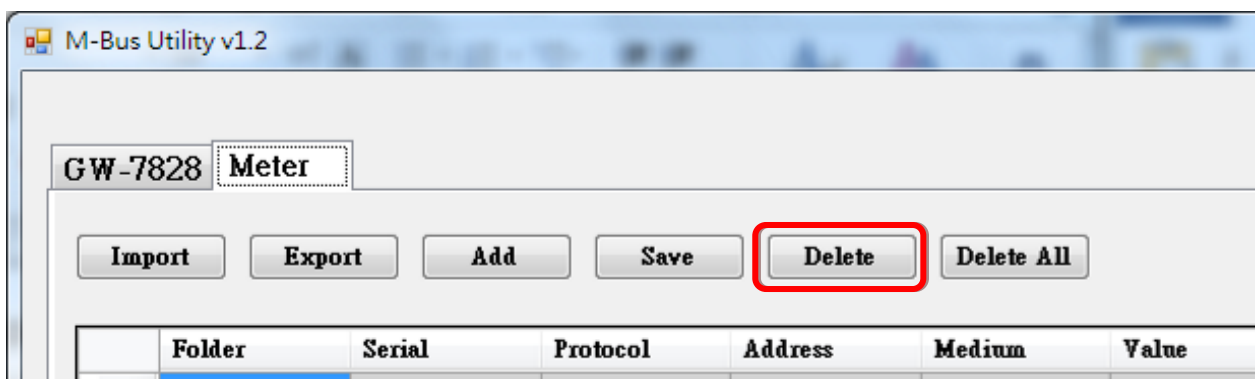

Step2: Select the serial number of meter which wanting to be deleted.

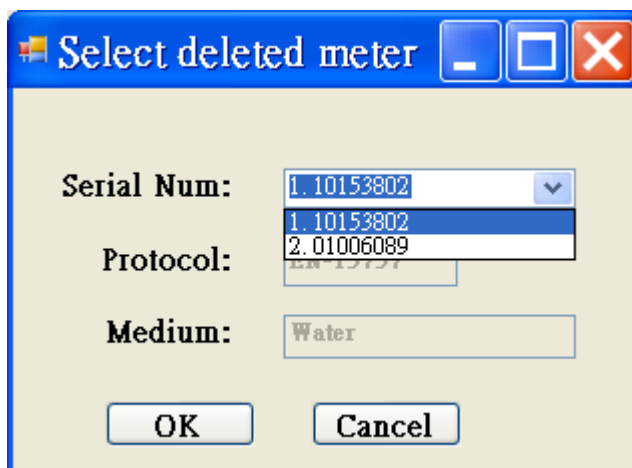

Step3: Confirm to delete meter which is selected.



Step4: it will show the meter information after deleting as below.

GW-7828 Meter

Import Export Scan Add Save Delete Delete All

Folder	Serial	Protocol	Address	Medium	Value	Unit	Cycle	Description	Register
1	01006089	EM-13757	2	12. Heat (inlet)			60		
					32 Bit Integer	10 <sup>3</sup> Wh		Energy	001B
					32 Bit Integer	10 <sup>-3</sup> m <sup>3</sup>		Volume	001D
					32 Bit Integer	10 <sup>-3</sup> m <sup>3</sup>		Volume	001F
					16 Bit Integer	℃		Flow Temper...	0021
					16 Bit Integer	℃		Return Temp...	0022
					16 Bit Integer	10 <sup>-4</sup> K		Temperature ...	0023
					32 Bit Integer	hours		On Time	0024
					32 Bit Integer	hours		Operating Time	0026
					32 Bit Integer	10 <sup>-3</sup> m <sup>3</sup> /h		Volume Flow	0028
					32 Bit Integer	10 <sup>4</sup> W		Power	002A
					32 Bit Integer	time & date		Time Point	002C
					32 Bit Integer			Units for H.C...	002E
					32 Bit Integer			Units for H.C...	0030

Step5: After delete meter configuration completely, press “Save” to save change to GW-7828.

### 3.3.6 Delete All

The “Delete All” function can delete all meters setting on the utility list.

Step1: Press “Delete All” button.

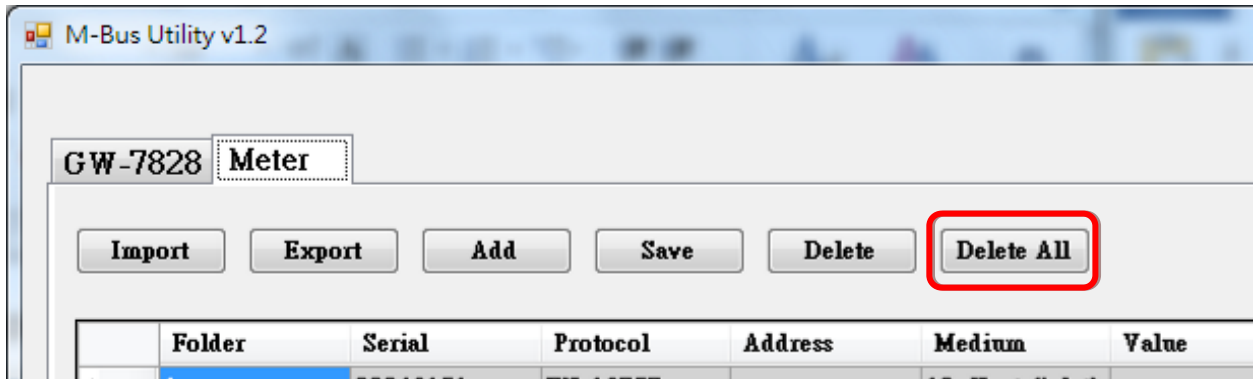

Step2: Confirm to delete all meters' configuration.

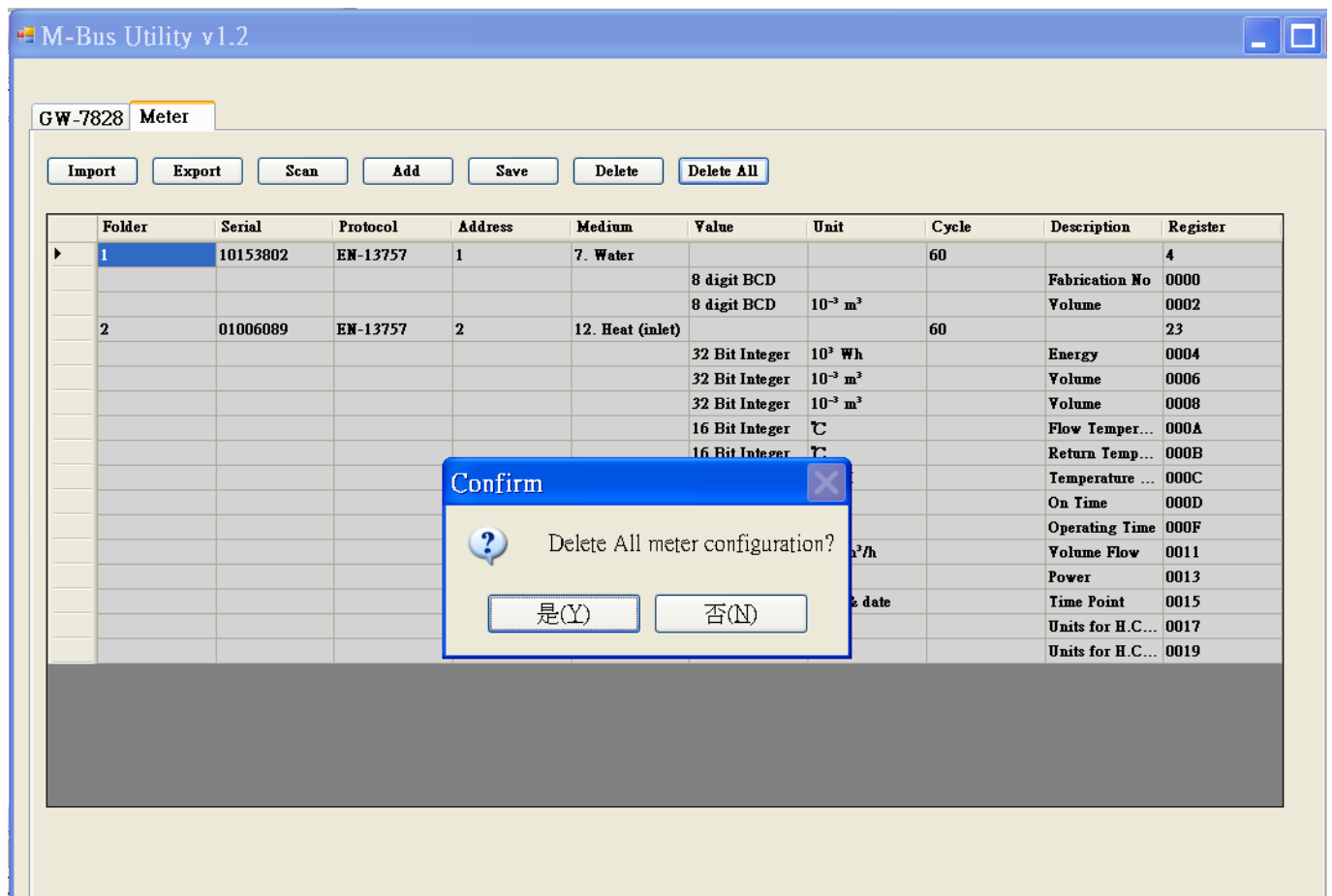

Step3: Finally press “Save” to save changing configuration.

### 3.4 M-Bus Meter Communicate Test

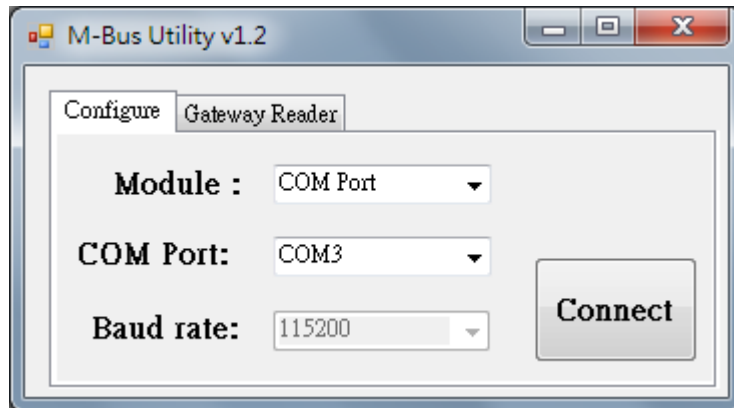

After the meter is configured, the user can re-execute the M-Bus utility and then click “Gateway Reader” to read the meter data and check if the settings are correct.

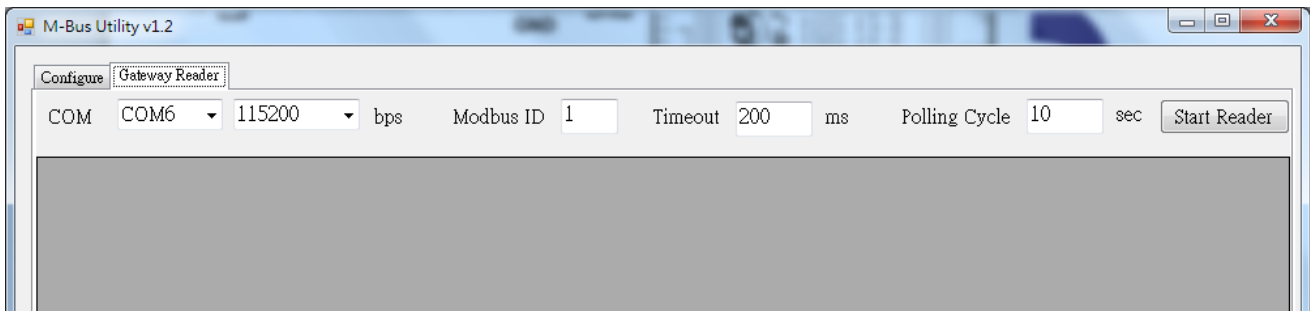

After executing the “Gateway Reader”, select the COM port and timeout related options, and press the “Start Reader” button to import the configuration file exported in Section 3.3.2.

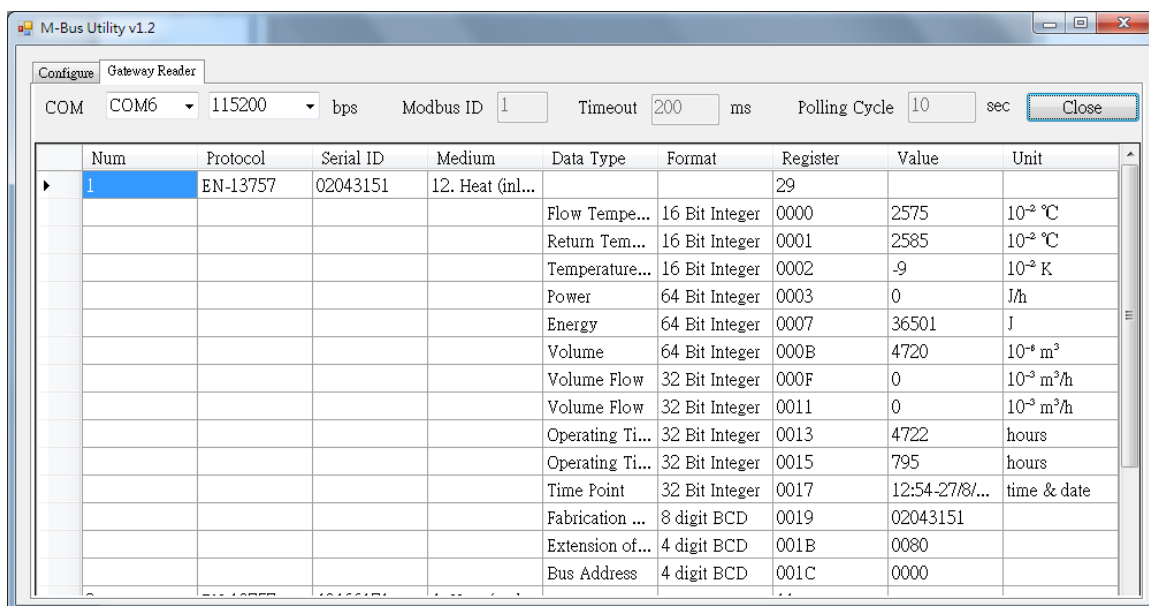

It can test whether the value read matches the setting.

## 4. Meter Configuration Label Description

After adding meters' configuration, the meters' information will be showed as below.

The screenshot shows the 'M-Bus Utility v1.2' application window. At the top, there is a title bar with the application name and standard window controls. Below the title bar, there is a toolbar with buttons for 'Import', 'Export', 'Scan', 'Add', 'Save', 'Delete', and 'Delete All'. The main area contains a table with the following data:

Folder	Serial	Protocol	Address	Medium	Value	Unit	Cycle	Description	Register
1	10153802	EM-13757	1	7. Water			60		4
					8 digit BCD			Fabrication No	0000
					8 digit BCD	10 <sup>-3</sup> m <sup>3</sup>		Volume	0002
2	01006089	EM-13757	2	12. Heat (inlet)			60		23
					32 Bit Integer	10 <sup>3</sup> Wh		Energy	0004
					32 Bit Integer	10 <sup>-3</sup> m <sup>3</sup>		Volume	0006
					32 Bit Integer	10 <sup>-3</sup> m <sup>3</sup>		Volume	0008
					16 Bit Integer	°C		Flow Temper...	000A
					16 Bit Integer	°C		Return Temp...	000B
					16 Bit Integer	10 <sup>-4</sup> K		Temperature ...	000C
					32 Bit Integer	hours		On Time	000D
					32 Bit Integer	hours		Operating Time	000F
					32 Bit Integer	10 <sup>-3</sup> m <sup>3</sup> /h		Volume Flow	0011
					32 Bit Integer	10 <sup>4</sup> W		Power	0013
					32 Bit Integer	time & date		Time Point	0015
					32 Bit Integer			Units for H.C...	0017
					32 Bit Integer			Units for H.C...	0019

There are some labels to record the meters' information for user's reference. User can find the meaning of the labels in the following section.

## 4.1 Serial

The “Serial” column records serial number of meters. Each meter that complies with the EN-13757 specification will have a set of 8-digit serial numbers, while meters that comply with the CJ / T-188 specification will have a set of 14-digit serial numbers. The meter serial number will be displayed in each meter data in the first column of the “Serial” field.

EN-13757	CJ/T-188														
<table border="1"><thead><tr><th>Serial</th></tr></thead><tbody><tr><td>10153802</td></tr><tr><td></td></tr><tr><td></td></tr><tr><td>01006089</td></tr><tr><td></td></tr><tr><td></td></tr><tr><td></td></tr></tbody></table>	Serial	10153802			01006089				<table border="1"><thead><tr><th>Serial</th></tr></thead><tbody><tr><td>00380000001...</td></tr><tr><td></td></tr><tr><td></td></tr><tr><td></td></tr><tr><td></td></tr></tbody></table>	Serial	00380000001...				
Serial															
10153802															
01006089															
Serial															
00380000001...															

## 4.2 Protocol

The “Protocol” field is used to indicate which specification of the meter following. GW-7828 supports two protocols EN-13757 and CJ/T-188.

EN-13757	CJ/T-188								
<table border="1"><thead><tr><th data-bbox="512 566 711 607">Protocol</th></tr></thead><tbody><tr><td data-bbox="512 607 711 647">EN-13757</td></tr><tr><td data-bbox="512 647 711 687"> </td></tr><tr><td data-bbox="512 687 711 728"> </td></tr></tbody></table>	Protocol	EN-13757			<table border="1"><thead><tr><th data-bbox="844 566 1043 607">Protocol</th></tr></thead><tbody><tr><td data-bbox="844 607 1043 647">CJ/T-188</td></tr><tr><td data-bbox="844 647 1043 687"> </td></tr><tr><td data-bbox="844 687 1043 728"> </td></tr></tbody></table>	Protocol	CJ/T-188		
Protocol									
EN-13757									
Protocol									
CJ/T-188									



## 4.3 Address

The “Address” field is expected to record address of the meter, which is reserved now.

## 4.4 Medium

The “Medium” field records medium of meters. It will show the medium of meters according to the definition in EN-13757 protocol or CJ/T-188 protocol.

Medium
7. Water
12. Heat (inlet)

## 4.5 Value

The “Value” field records value type of meters’ data. It will show the value type of meters’ data according to the definition in EN-13757 protocol or CJ/T-188 protocol.

<b>Value</b>
<b>8 digit BCD</b>
<b>8 digit BCD</b>
<b>32 Bit Integer</b>
<b>32 Bit Integer</b>
<b>32 Bit Integer</b>
<b>16 Bit Integer</b>

## 4.6 Unit

The “Unit” field records unit of meters’ data. It will show the unit of meters’ data according to the definition in EN-13757 protocol or CJ/T-188 protocol.

Unit
$10^{-3} \text{ m}^3$
$10^3 \text{ Wh}$
$10^{-3} \text{ m}^3$
$10^{-3} \text{ m}^3$
°C
°C
$10^{-1} \text{ K}$
hours
hours
$10^{-3} \text{ m}^3/\text{h}$
$10^1 \text{ W}$
time & date

## 4.7 Cycle

The “Cycle” field records the minimum cycle time (unit is sec.) for polling all meters’ data. Please be noted that the cycle time parameter is for all meters of the M-Bus network.

Cycle
60

## 4.8 Description

The “Description” field records meaning of meters’ data. It will show the real meaning of meters’ data according to the definition in EN-13757 protocol or CJ/T-188 protocol.

Description
<b>Fabrication No</b>
<b>Volume</b>
<b>Energy</b>
<b>Volume</b>
<b>Volume</b>
<b>Flow Temper...</b>
<b>Return Temp...</b>
<b>Temperature ...</b>
<b>On Time</b>
<b>Operating Time</b>
<b>Volume Flow</b>
<b>Power</b>

## 4.9 Register

The “Register” field records the total word count and the Modbus address of every data at GW-7828. Take the below as an example, this is a water meter (Medium) of EN-13757 protocol (Protocol) with serial number 10153802 (Serial). It has total 4 words data length (Register) and 1<sup>st</sup> data is 8 digit BCD type (Value) from Modbus address 0x0000 ~ 0x0001 (Register) and 2<sup>nd</sup> data is also 8 digit BCD type (Value) from Modbus address 0x0002 ~ 0x0003 (Register). The GW-7828 will update the meter data as fast as per 60 second one time (Cycle).

	Folder	Serial	Protocol	Address	Medium	Value	Unit	Cycle	Description	Register
▶	1	10153802	EN-13757	1	7. Water			60		4
						8 digit BCD			Fabrication No	0000
						8 digit BCD	10 <sup>-3</sup> m <sup>3</sup>		Volume	0002

**Note:** If GW-7828 updates all meters data faster than setting cycle time 60 second, the all meters data will be update every 60 second. But if slower than 60 seconds, GW-7828 will update all meters data as soon as possible.

# Appendix A. Firmware Update

The firmware on the GW-7828 module can be updated via COM Port. The latest firmware file (\*.fw file) and the latest version of the firmware update utility (FW\_Update\_Tool.zip) are available from the web link below. A notification will not be sent when a new version is released.

[http://ftp.icpdas.com.tw/pub/cd/fieldbus\\_cd/m-bus/gateway/GW-7828/firmware/](http://ftp.icpdas.com.tw/pub/cd/fieldbus_cd/m-bus/gateway/GW-7828/firmware/)

[http://ftp.icpdas.com.tw/pub/cd/fieldbus\\_cd/m-bus/gateway/GW-7828/software/](http://ftp.icpdas.com.tw/pub/cd/fieldbus_cd/m-bus/gateway/GW-7828/software/)

Following shows the firmware update process for GW-7828 using firmware update utility.

**Step 1:** Move DIP switches to the firmware update mode (Init ON) and reboot the module.

**Step 2:** Run firmware update utility, FW\_Update\_Tool\_vX.XX.exe (X denotes version number).

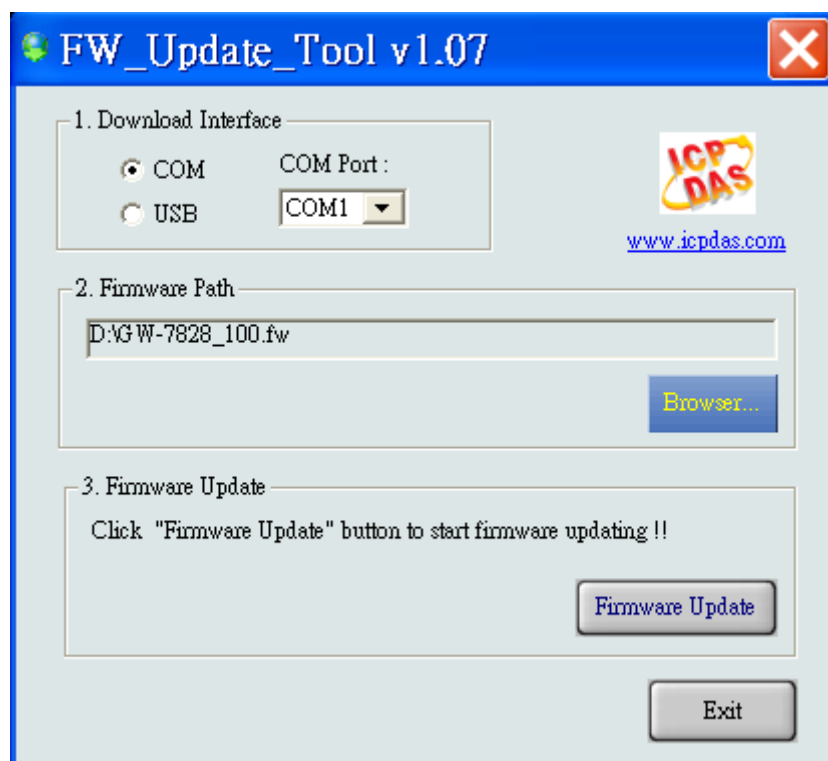

## ● Download the Firmware:

- (1) Click the “**Browser...**” button to select the location of the firmware file. The name of the firmware file is GW-7828\_XXX.fw (X denotes version number).
- (2) Click the “ **Firmware Update**” button to begin the firmware update process. Once the firmware has been successfully updated, a notification “Firmware Update Success” will be displayed.



## Appendix B. Revision History

This chapter provides revision history information to this document.

The table below shows the revision history.

Revision	Date	Description
1.0.0	January 2020	First Release