



M-7068(D)/M-7069(D) Quick Start

REV1.00



Warranty

All products manufactured by ICP DAS are under warranty regarding defective materials for a period of one year from the date of delivery to the original purchaser.

Warning

ICP DAS assumes no liability for damage resulting from the use of this product. ICP DAS reserves the right to change this guide at any time without notification. The information furnished by ICP DAS is believed to be accurate and reliable. However, no responsibility is assumed by ICP DAS for its use, nor for any infringements of patents or other rights of third parties resulting from its use.

Packing List

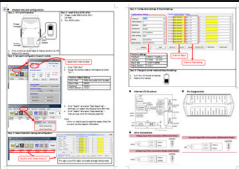
<p>M-7068(D), M-7069(D)</p> 	<p>Plastic Rail</p> 	<p>CD</p> 	<p>Quick Start Guide</p> 
---	---	--	--

Internal I/O Structure < M-7068(D), M-7069(D) >

Pin Assignments < M-7068(D), M-7069(D) >

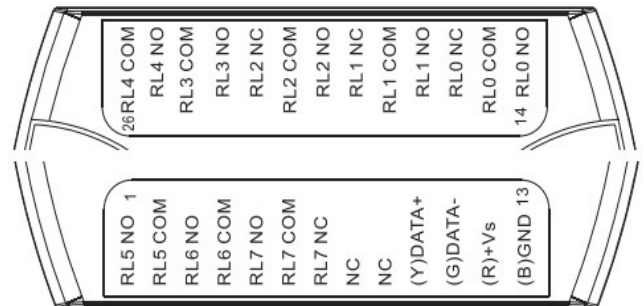
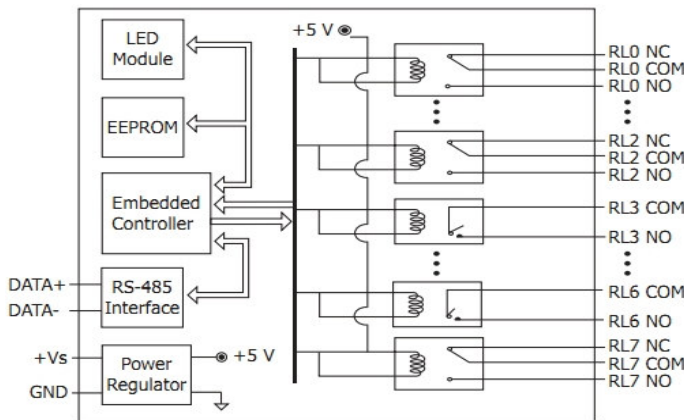

Wire Connections < M-7068(D), M-7069(D) >

Relay Output	ON State Readback as 1	OFF State Readback as 0
Form A Relay in RL3 ~ RL6		
Form C Relay in RL0 ~ RL2 and RL7		



Modbus Table

Address	Description	R/W
00001 ~ 00004	DO Value	R/W
00033 ~ 00036 10001 ~ 10004	DI Value	R
00065 ~ 00068	DI Latch High Value	R
00069 ~ 00072	DO Latch High Value	R
00097 ~ 00100	DI Latch Low Value	R
00101 ~ 00104	DO Latch Low Value	R
00264	Write 1 to clear latch values (FC 05)	W
00513 ~ 00516	Write 1 to clear DI counter (FC 05, FC15)	W
30001 ~ 30004 40001 ~ 40004	DI Counter Value	R

DCON Protocol

Function	Command	Response	Notes
Reads the name of the module	\$AAM	!AA(Data)	AA: module address
Reads the firmware version of the module	\$AAF	!AA(Data)	
Reads the status of the digital output channels	@AA	(Data)	
Sets the digital output channels	@AA(Data)		0~F
Reads the digital input counter of channel N	#AAN	!AA(Data)	N: The channel to be read (0~3)
Clears the digital input counter of channel N	\$AACN	!AA	
Reads the status of the latched DO channels	\$AALS	!(Data)	S: 0 is low, 1 is high
Clears the status of the latched DO channels	\$AAC	!AA	

For more details regarding the DCON protocol, please check the enclosed CD at:

CD path: <\\napdos\7000>manual>

Or from our web site at: <ftp://ftp.icpdas.com/pub/cd/8000cd/napdos/7000/manual/>

Module Test and Configuration

Step 1: INIT switch Operation

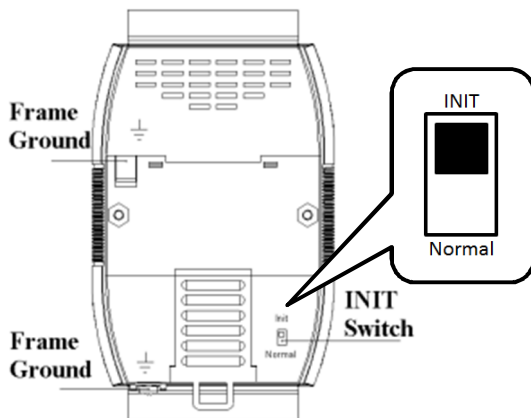

1. Locate the INIT switch on the back of the module, and set it to the INIT position.
2. Reboot the module

Step 2: Install and run the DCON Utility

1. First install the DCON Utility, which can be found in the following location on the enclosed CD.

<CD drive>:\napdos\driver\dcon_utility\

Or at our web site at:

http://ftp.icpdas.com/pub/cd/8000cd/napdos/driver/dcon_utility/

2. Run the DCON utility



DCON_UTILITY

Step 3: Set the configuration and search for the module

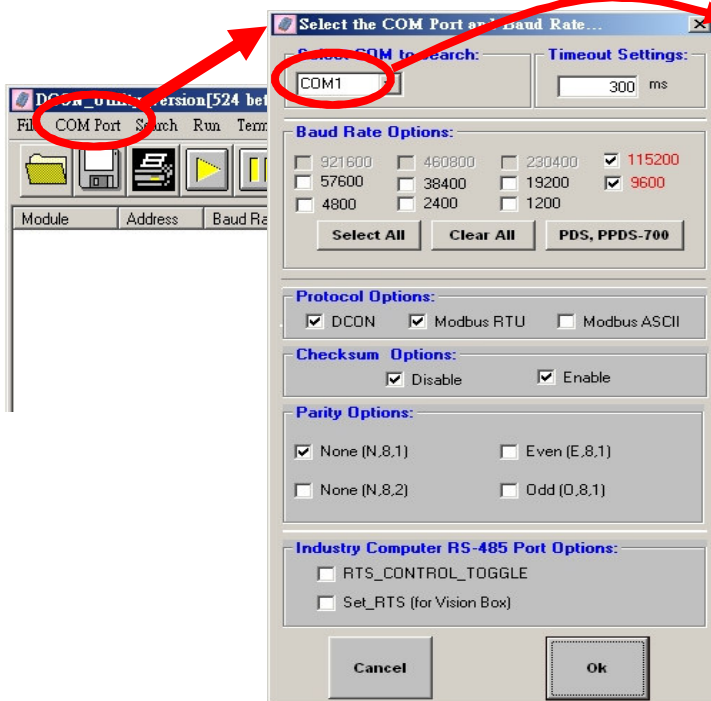

Select the COM Port to search for Number

1. Click "COM Port" in the main menu
2. Select the appropriate communication information settings and click the "OK" button.

Default Module Settings	
COM Port	Refers to the Port Number of the converter
Baud Rate	9600
Protocol	DCON for I-7000 series module Modbus RTU for M-7000 series module.
Parity Option	N,8,1

3. Click "Search" in the main menu and select the "Start Searching" option, the DCON Utility will search for modules connected to the selected COM Port.
4. Once the module has been located, click "Search" in the main menu, and then select the "Stop Searching" option to manually end the search process.

Note:

If no module is found during the search process, check the wire connection and communication information settings and try again.

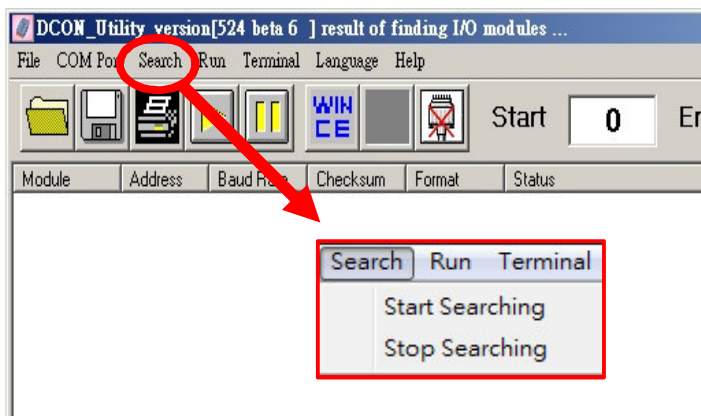

Step 4: Select the Module to be used for testing and configuration

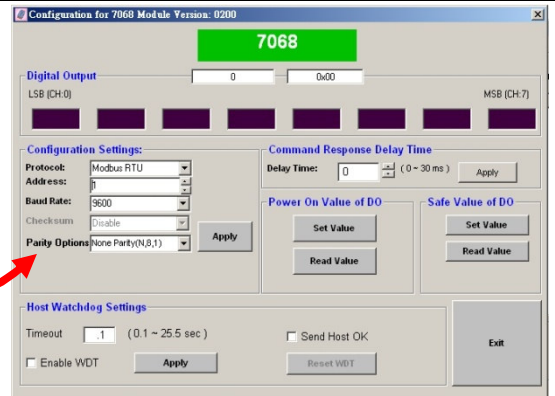
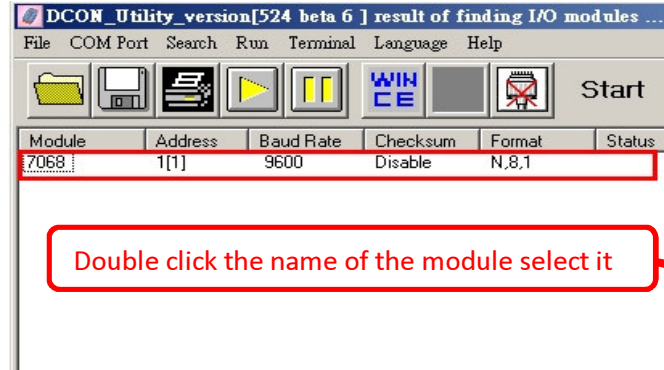

Step 5: Configuration Settings and Channel Settings

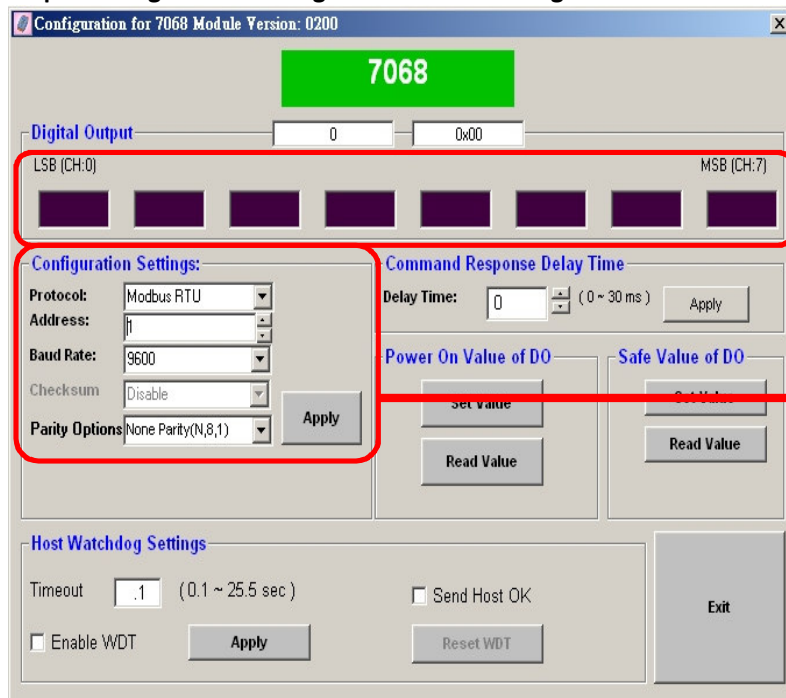

Module Settings	
Protocol	DCON/Modbus
Address	1~255 (0: INIT)
Baud Rate	1200~115200
Parity Options	N,8,1

Step 6: Change to Normal mode and save the settings

1. Set the INIT Switch to the Normal position.
2. Reboot the module



Troubleshooting

Q1. What should I do if I have forgotten the module address and/or baud rate?

Set the INIT switch to the INIT mode, and run the DCON Utility to search for the module.

The module supports the DCON protocol in "INIT" mode, and the address of the module will be 0 with communication settings of "9600, N, 8, 1". (Baud Rate, Parity)

Q2. How do I configure I-7000 and M-7000 modules?

ICP DAS provides the DCON Utility that can be used to configure I-7000 and M-7000 modules.

The most recent version can be downloaded from: http://ftp.icpdas.com/pub/cd/8000cd/napdos/driver/dcon_utility/

Q3. How do I program the I-7000 or M-7000 using C#, VB, VC?

The ICP DAS I-7000 and M-7000 series of modules both support the DCON protocol, but the M-7000 series only supports the Modbus protocol.

The SDK and demo applications for the DCON protocol can be downloaded from:

http://ftp.icpdas.com/pub/cd/8000cd/napdos/driver/dcon_dll_new/

For details regarding the Modbus protocol, please refer to the following web site

<http://www.icpdas.com/products/PAC/i-8000/modbus.htm>

If you have any other questions, please feel free to contact us via email at service@icpdas.com, or through our website at http://www.icpdas.com.tw/contact_us/contact_us.html